

***COMPENDIUM
OF INTERNATIONAL
METHODS OF WINE
AND MUST ANALYSIS***

EDITION 2022

VOLUME 2



INCLUDED :

***Resolutions adopted in the 19th General Assembly
6th July 2021 – Paris (France)***

Printed in Paris (France)

35, Rue de Monceau

75008 Paris, France

Legal Deposit : August 2021

ISBN : 978-2-85038-052-5

ISBN Volume II : 978-2-85038-054-9

Method OIV-MA-AS315-01

Type IV method

Acetaldehyde
(Resolution Oeno 377/2009)

1. Principle

Acetaldehyde (ethanal) in carbon decolorized wine, reacts with sodium nitroferricyanide and piperidine and causes a green to violet color change whose intensity is measured at 570 nm.

2. Apparatus

Spectrophotometer permitting measurement of absorbance at a wavelength of 570 nm with a 1 cm optical cell path.

3. Reagents

3.1 Piperidine solution, (C₅H₁₁N) 10% (v/v).

Prepare just before use by mixing 2 mL of piperidine with 18 mL of distilled water.

3.2 Sodium nitroferricyanide solution, 0.4% (m/v).

In a 250 mL glass volumetric flask, dissolve 1 g of pulverized sodium nitroferricyanide, Na₂ [Fe(CN)₅ NO].2H₂O in distilled water and make up to volume.

3.3 Activated carbon

3.4 Dilute hydrochloric acid, 25% (v/v)

3.5 Alkaline solution

Dissolve 8.75 g of boric acid in 400 mL sodium hydroxide solution, 1 M. Make up to 1 L with distilled water.

4. Procedure

4.1 *Sample*

Place approx. 25 mL of wine in a 100 mL Erlenmeyer flask, add 2 g of activated charcoal. Shake vigorously for a few seconds, allow to stand for 2 minutes and filter through a fluted slow filter to obtain a clear filtrate.

Place 2 mL of the clear filtrate into a 100 mL Erlenmeyer flask, add, while shaking, 5 mL of the sodium nitroferricyanide solution (3.2) and 5 mL of the piperidine solution (3.1). Mix and place the mixture immediately into a 1 cm optical cell. The coloration produced, which varies from green to violet, is measured with reference to air at a wavelength of 570 nm. This color change increases then decreases rapidly; measure immediately and record the maximum value of the absorbance that is obtained after about 50 seconds. The concentration of acetaldehyde in the liquid analyzed is obtained using a calibration curve.

Note: If the liquid analyzed contains excess free acetaldehyde, it will be necessary, before beginning the total acetaldehyde determination, to first combine it with sulfur dioxide. To achieve this, add a small amount of excess free SO₂ to a portion of the liquid to be analyzed and wait for an hour before proceeding.

4.2. Preparation of the calibration curve

4.2.1 Solution of acetaldehyde combined with sulfur dioxide

Prepare a solution of between 5 to 6% (*m/v*) sulfur dioxide and determine the exact strength by titrating with 0.05 M iodine solution.

In a 1 L glass volumetric flask, add a volume of this solution which corresponds to 1500 mg of sulfur dioxide. Introduce into the flask, using a funnel, about 1 mL of acetaldehyde distillate recently distilled and collected in a cooling mixture. Make up to 1 liter with distilled water. Mix and allow to stand overnight.

The exact concentration of this solution is determined as follows:

Place in a 500 mL Erlenmeyer flask, 50 mL of the solution; add 20 mL of dilute hydrochloric acid (3.4) and 100 mL water. Titrate the free sulfur dioxide using a solution of 0.05 M iodine with starch as indicator, stopping at a faint blue end point. Add 100 mL of the alkaline solution, and the blue coloration will disappear. Titrate the combined sulfur dioxide and acetaldehyde with 0.05 M iodine until a faint blue end point is reached: let *n* be the volume used.

The acetaldehyde solution combined with SO₂ contains 44.05 *n* mg of acetaldehyde per liter.

4.2.2 Preparation of the calibration standards

In five 100 mL glass volumetric flasks, place respectively 5, 10, 15, 20 and 25 mL of the stock solution. Make up to volume with distilled water. These solutions correspond to acetaldehyde concentrations of 40, 60, 120, 160 and 200 mg/L. The exact concentration of the dilutions must be calculated from the acetaldehyde concentration of the stock solution (4.2.1) previously determined.

Proceed with the determination of acetaldehyde on 2 mL of each of these dilutions as indicated in 4.1. The graph of the absorbance of these solutions as a function of acetaldehyde content is a straight line that does not pass through the origin.

BIBLIOGRAPHY

REBELEIN H., *Dtsch. Lebensmit. Rdsch.*, 1970, **66**, 5-6.

Method OIV-MA-AS315-02A

Type IV method

Ethyl Acetate

1. Principle of the methods

Ethyl acetate is determined by gas chromatography on wine distillate using an internal standard.

2. Method

2.1 *Apparatus* (see chapter *Volatile Acidity*).

2.2 *Procedure*

Prepare an internal standard solution of 4-methyl-2-pentanol, 1 g/L, in ethanol solution, 10% (v/v).

Prepare the sample solution to be determined by adding 5 mL of this internal standard solution to 50 mL of wine distillate obtained as indicated in the chapter on *Alcoholic Strength*.

Prepare a reference solution of ethyl acetate, 50 mg/L, in ethanol, 10% (v/v). Add 5 mL of the internal standard to 50 mL of this solution.

Analyze 2 μ L of the sample solution and the reference solution using gas chromatography.

Oven temperature is 90°C and the carrier gas flow rate is 25 mL per minute.

2.3 *Calculation*

S = the peak area of ethyl acetate in the reference solution.

S_x = the peak area of the ethyl acetate in the sample solution.

I = the peak area of the internal standard in the sample solution.

I = the peak area of the internal standard in the reference solution.

The concentration of ethyl acetate, expressed in milligrams per liter, is given by:

$$50 \times \frac{I}{I} \times \frac{S_x}{S}$$

Ethyl Acetate

1. Principle of the methods

Ethyl acetate is separated by distillation of wine brought to pH 6.5. After saponification and suitable concentration in an alkaline environment, the distillate is acidified and the vapor condensed to separate the acetic acid liberated by saponification; the acid portion is titrated with the alkaline solution.

2. Method

2.1 Reagents

2.1.1 Sodium hydroxide solution, 1 M

2.1.2 pH 6.5 Buffer solution

Potassium <i>di</i> -hydrogen phosphate, KH_2PO_4	5 g
Sodium hydroxide solution 1 M	50 mL
Water to	1 L

2.1.3 Crystalline tartaric acid

2.1.4 Sodium hydroxide solution, 0.02 M

2.1.5 Neutral phenolphthalein solution, 1%, in alcohol, 96% (v/v).

2.2 Usual method

Into a 500 mL volumetric flask, place 100 mL of non-decarbonated wine neutralized with n mL of 1 M sodium hydroxide solution, n being the volume of sodium hydroxide solution, 0.1 M, used for measuring the total acidity of 10 mL of wine. Add 50 mL of pH 6.5 buffer solution and distill. The distillation must be conducted using a tapered tube into a 500 mL round-bottom flask containing 5 mL of 1 M sodium hydroxide solution, on which a mark has been made indicating a volume of approximately 35 mL. Collect 30 mL of distillate.

Stopper the flask and allow to stand for one hour. Concentrate the contents of the flask to approximately 10 mL by placing it in a boiling water bath and blowing a rapid stream of air into the bowl of the flask. Allow to cool. Add 3 g tartaric acid (2.1.3). Eliminate carbon dioxide by shaking under a vacuum. Transfer the liquid from the concentrating flask to the bubbling chamber of a steam distillation apparatus and rinse the flask twice with 5 mL of water. Steam distill and recover at least 250 mL of distillate.

Titrate with a 0.02 M sodium hydroxide solution, in the presence of phenolphthalein.

2.3 Calculation

Let n be the number of milliliters of sodium hydroxide solution, 0.02 M (2.1.4) used. 1 mL corresponds to 1.76 mg ethyl acetate.

The concentration of ethyl acetate in milligrams per liter is given by:

$$17.6 \times n$$

BIBLIOGRAPHY

Usual method:

PEYNAUD E., *Analyse et contrôle des vins*, Librairie Polytechnique Ch.-Béranger, 1958.

Malvidin diglucoside

1. Principle

Malvidin diglucoside, oxidized by nitric acid, is converted to a substance that, in an ammonium medium, emits a vivid green fluorescence in ultraviolet light.

The intensity of the fluorescence of the compound formed is measured by comparison with the fluorescence of a solution titrated with quinine sulfate whose intensity of fluorescence is standardized with the malvidin diglucoside reference.

Free sulfur dioxide, which attenuates the fluorescence, must previously be combined with excess acetaldehyde.

2. Qualitative Examination

2.1 Apparatus

2.1.1 Ultraviolet lamp permitting measurement at 365 nm.

2.2 Reagents

2.2.1 Acetaldehyde solution

Crystallizable paraldehyde	10 g
Ethanol 96% (v/v)	100 mL

2.2.2 Hydrochloric acid, 1.0 M.

2.2.3 Sodium nitrate solution, 10 g/L.

2.2.4 Ethanol, 96% (v/v), containing 5% concentrated ammonia solution ($\rho_{20} = 0.92$ g/mL).

2.2.5 Control wine containing 15 mg of malvidin diglucoside per liter.

2.2.6 Wine containing no malvidin diglucoside.

2.3 Method

Into a test tube add:

- 10 mL of wine
- 1.5 mL of acetaldehyde solution

wait 20 minutes.

Into a 20 mL centrifuge tube place:

- 1 mL of wine reacted with acetaldehyde
- 1 drop of hydrochloric acid
- 1 mL sodium nitrate solution

Stir; wait 2 minutes (5 minutes maximum); add:

- 10 mL ammoniacal ethanol

Treat similarly 10 mL of wine containing 15 mg/L malvidin diglucoside (The control wine). Stir. Wait 10 minutes and centrifuge.

Decant the clear liquids from the top into calibrated test tubes. Observe the difference in green fluorescence between the test wine and the control wine under ultraviolet light at 365 nm.

For rose wines, it is possible to increase the sensitivity using:

- 5 mL of wine treated with acetaldehyde (2.3)
- 0.2 mL hydrochloric acid, 1 M (2.2.2)
- 1 mL sodium nitrate solution, 10 g/L (2.2.3)
- 5.8 mL ammoniacal ethanol (2.2.4)

Treat the control wine in a similar manner.

2.4 Interpretation

Wines that do not fluoresce, or have a distinctly lower fluorescence, than the control, may be considered to have no malvidin diglucoside. Those whose fluorescence is slightly less than, equal to, or greater than the control should have a quantitative determination.

3. Quantitative Determination

3.1. Apparatus

3.1.1. Equipment for measuring fluorescence:

- excitation wavelength 365 nm;
- wavelength of fluorescent radiation 490 nm.

3.1.2. Optical quartz cell (1 cm path length)

3.2 Reagents

3.2.1. See qualitative examination

3.2.2. 2 mg/L quinine sulfate solution

Prepare a solution containing 10 mg very pure quinine sulfate in 100 mL sulfuric acid, 0.1 M. Dilute 20 mL of this solution to 1 liter with sulfuric acid solution, 0.1 M.

3.3 Procedure

Treat the wine by the method described in *Qualitative examination (2)*, except that the aliquot of acetaldehyde treated wine is each case (red wines and roses) 1 mL.

Place the 2 mg/L solution of quinine sulfate in the cell, adjust the fluorometer to the full range (transmission T, equal to 100%) by adjusting the slit width or the sensitivity.

Replace this tube with the one containing the test wine: this is the T_1 value.

If the percentage of transmission, T_1 is greater than 35, dilute the wine with wine without malvidin diglucoside whose fluorescence must be less than 6% (this should be ascertained by previous testing.)

Remarks:

1. Salicylic acid (sodium salicylate) added to the wine for stabilization before analysis, causes a spurious fluorescence which can be eliminated by an extraction with ether.
2. Spurious fluorescence is caused by the addition of caramel.

3.4 Calculation

A fluorescence intensity of 1, for wine without SO_2 , for the operating conditions above with the exception of the acetaldehyde treatment, corresponds to 0.426 mg malvidin diglucoside per liter of wine.

On the other hand, red and rose wines, containing no malvidin diglucoside, give fluorescence corresponding to a T value of the order of 6%.

The amount of malvidin diglucoside in wine in milligrams per liter is therefore:

$$(T_1 - 6) 0,426 \times \frac{11,5}{10} = (T_1 - 6) \times 0,49$$

If the wine is diluted, multiply the result by the dilution factor.

3.5 Expression of the Results

The amount of malvidin diglucoside is expressed in milligrams per liter of wine to the nearest whole number.

BIBLIOGRAPHY

- DORIER P., VERELLE L., *Ann. Fals. Exp. Chim.*, 1966, **59**, 1.
GAROGGIO P.G., *Rivista Vitic. Enol.*, 1968, **21**, 11.
BIEBER H., *Deutsche Lebensm. Rdsch.*, 1967, 44-46.
CLERMONT Mlle S., SUDRAUD P., *F.V., O.I.V.*, 1976 n° 586.

Method OIV-MA-AS315-04

Type II method

Ethyl Carbamate
(Resolution Oeno 8/98)

Ethyl carbamate analysis in alcoholic beverages: selective detection method by gas chromatography/mass spectrometry

(Applicable to the determination of ethyl carbamate concentrations between 10 and 200 µg/l).

(Caution: respect safety measures when handling chemical products, ethanol, acetone and carcinogenic products: ethyl carbamate and dichloromethane. Get rid of used solvents in a suitable way, compatible with applicable environmental rules and regulations).

1. Principle

Propyl carbamate is added to a sample as an internal standard, the solution is diluted with water and placed in a 50 mL solid phase extraction column. Ethyl carbamate and propyl carbamate are eluted with dichloromethane. The eluate is concentrated in a rotary evaporator under vacuum. The concentrate is analyzed by gas chromatography/mass spectrometry using selected ion monitoring mode.

2. Apparatus

2.1 Gas chromatograph/mass spectrometer (GC/MS). With selected ion monitoring (SIM), and data handling system. An autosampler is desirable.

2.2 Capillary fused silica column: 30m* × 0.25 mm Ø int., 0.25 µm of Carbowax 20M type.

2.3 Operating conditions: injector 180°C, helium carrier gas at 1 mL/min at 25°C, splitless injection. Temperature program: 40°C for 0.75 min, then program 10°C/min to 60°C, then 3°C**/min to 150°C, post run: go up to 220°C and maintain for 4.25 min at 220°C. The retention time for ethyl carbamate is 23-27 min., that of propyl carbamate is 27-31 min.

GC/MS interface: transfer line 220°C. Mass spectrometer parameters set up manually with perfluorotributylamine and optimized for a lower mass

* For certain wines which are particularly rich, it may be desirable to use a 50m long capillary column.

** For certain wines which are particularly rich, it may be desirable to carry out a temperature program of 2°C per minute.

sensitivity, SIM acquisition mode, solvent delay and time for the start of acquisition 22 min., dwell time/ion 100 ms.

- 2.4 Rotary evaporator under vacuum or concentration system similar to Kuderna Danish. (Note: the recovery of the ethyl carbamate test sample, (3.7) must be between 90-110% during the process).
- 2.5 Flask - pear-shaped, 300 mL, single neck, 24/40 standard taper joint.
- 2.6 Concentrator tube - 4 mL, graduated, with a standard taper 19/22 Teflon coated joint and stopper.

3. Reagents

- 3.1 *Acetone* - HPLC quality. *Note:* Check each batch by GC/MS before use with regard to the absence of response for m/z 62, 74 and 89 ions.
- 3.2 *Dichloromethane* - *Note:* Analyze each batch before use by GC/MS after 200 fold concentration to check the absence of response for m/z 62, 74 and 89 ions.
- 3.3 *Ethanol - anhydrous*
- 3.4 *Ethyl carbamate (EC) standard solutions*
- (1) Stock solution - 1.00 mg/mL. Weigh 100 mg EC ($\geq 99\%$ purity) in a volumetric flask of 100 mL and dilute to mark with acetone.
 - (2) Standard working solution- 10.0 $\mu\text{g/mL}$. Transfer 1 mL of the EC stock solution to a 100 mL volumetric flask and dilute with acetone to the mark.
- 3.5 *n-Propyl carbamate (PC), standard solutions.*
- (1) Stock solution - 1.00 mg/mL. Weigh 100 mg PC (reagent quality) in a 100 mL volumetric flask and dilute with acetone to the mark.
 - (2) Standard working solution- 10.0 $\mu\text{g/mL}$. Transfer 1 mL of the PC stock solution to a volumetric flask of 100 mL and dilute with acetone to the mark.
 - (3) Internal standard solution PC - 400 ng/mL. Transfer 4 mL of the standard PC working solution to a volumetric flask of 100 mL and dilute with water to the mark.
- 3.6 *EC - nPC standard calibration solutions* - Dilute the standard working solutions of EC, 3.4 (2), and PC 3.5 (2), with dichloromethane in order to obtain:
- (1) 100 ng EC and 400 ng nPC/mL,
 - (2) 200 ng EC and 400 ng nPC/mL,
 - (3) 400 ng EC and 400 ng nPC/mL,
 - (4) 800 ng EC and 400 ng nPC/mL,
 - (5) 1600 ng EC and 400 ng nPC/mL.

3.7 Practice sample - 100 ng EC/mL in 40 % ethanol. Transfer 1 mL of the standard EC working solution, 3.4 (2) in a 100 mL volumetric flask and dilute with 40 % of ethanol to the mark.

3.8 Solid phase extraction column - Disposable material, pre-packed with diatomaceous earth, capacity 50 mL.

(*Note:* Before analysis, check each batch of extraction columns for the recovery of EC and *n*PC and the absence of response for ions of *m/z* 62,74 and 89.) Prepare 100 ng EC/mL of test sample 3.7.

Analyze 5.00 mL of the test sample as described in 4.1, 4.2, 5, and 6. The recovery of 90-110 ng of EC/mL is satisfactory. Adsorbents whose particle diameter is irregular can lead to a slow flow that affects the recovery of EC and *n*PC.

If, after several trials, 90-110 % of the test sample value is not obtained, change the column or use a corrected calibration recovery curve to quantify EC.

To obtain the corrected calibration curve, prepare standard solutions as described in 3.6 by using 40 % ethanol instead of dichloromethane.

Analyze 1 mL of the standard calibration solution as described in 4, 5, and 6.

Establish a new standardization curve by using the EC/*n*PC ratio of the extracted standards.

4. Preparation of the test sample

Place the test material in 2 separate 100 mL beakers using the following quantities:

4.1 Wines containing over 14 % vol. alcohol: 5.00 mL ± 0.01 mL.

4.2 Wines containing maximum 14% vol. of alcohol: 20.00 mL ± 0.01 mL.

In each beaker, add 1 mL of internal standard PC solution, 3.5 (3) and water, in order to obtain a total volume of 40 mL (or 40 g).

5. Extraction

(*Note:* Carry out the extraction under a fume hood with adequate ventilation.)

Transfer diluted test portion from 4 to the extraction column.

Rinse the beaker with 10 mL of water and transfer the rinsing water to the column.

Let the liquid be absorbed in the column for 4 minutes. Elute with 2 □ 80 mL of dichloromethane.

Collect the eluate in a 300 mL pear-shaped flask.

Evaporate the eluate to 2 to 3 mL in a rotary evaporator in a water bath at 30°C

(*Note:* do not let extract evaporate to dryness).

Transfer the concentrated residue to a 4 mL graduated concentrator tube, with a 9 in Pasteur pipette.

Rinse the flask with 1 mL of dichloromethane and transfer the rinsing liquid to the tube.

Concentrate the sample to 1 mL under a slight nitrogen stream.

If an autosampler is used, transfer the concentrate to a vial for GC/MS analysis.

6. GC/MS Analysis

6.1 *Calibration curve* - Inject 1µl of each calibration standard solution 3.6, into GC/MS. Plot the graph of the EC-*n*PC area ratio for the response to m/z 62 ion on the y-axis and the quantity of EC in ng/mL on the x-axis (i.e., 100, 200, 400, 800, 1600 ng/mL).

6.2 *EC quantification* - Inject 1µl of concentrated extract from 5 in the GC/MS system and calculate the EC-*n*PC area ratio for m/z 62 ion. Determine the concentration of EC (ng/mL) in the extract by using the internal standard standardization curve. Calculate the EC concentration in the test sample (ng/mL) by dividing the quantity of EC (ng/mL) in the extract by the test sample volume 3.7.

6.3 *Confirmation of EC identity*. Determine if the response for m/z 62, 74 and 89 ions appear at the EC retention time. These responses characteristic respectively of the main fragments (M - C₂H₃ ·)⁺ and (M - CH₃ ·)⁺ and molecular ion (M). The presence of EC is confirmed if the relative ratio of these ions does not exceed 20% of the ratios of the EC standard. The extract may need to be further concentrated in order to obtain a sufficient response for the m/z 89 ion.

7. Method performance.

Sample		Mean EC found, ng/g	Recovery of added EC, %	S _r	S _R	RSD _r %	RSD _R %
Wine over 14 % alcohol (v/v)		40		1.59	4.77	4.01	12.02
		80	89	3.32	7.00	4.14	8.74
		162	90	8.20	11.11	5.05	6.84
Wine under 14% alcohol (v/v)		11		0.43	2.03	3.94	18.47
		25	93	1.67	2.67	6.73	10.73
		48	93	1.97	4.25	4.10	8.86

Hydroxymethylfurfural (HMF)

1. Principle of the methods

Aldehydes derived from furan, the main one being hydroxymethylfurfural, react with barbituric acid and para-toluidine to give a red compound which is determined by colorimetry at 550 nm.

Free sulfurous acid interferes with the determination. When its amount exceeds 10 mg/L, it must be previously eliminated by combining it with acetaldehyde whose excess does not interfere with the determination.

2. Colorimetric method

2.1 Apparatus

2.1.1 Spectrophotometer for making measurements between 300 and 700 nm.

2.1.2 Glass cells with optical paths of 1 cm.

2.2 Reagents

2.2.1 Barbituric acid solution, 0.5% (*m/v*)

Dissolve 500 mg of barbituric acid in distilled water by heating slightly over a water bath at 100°C. Make up to 100 mL with distilled water. This solution keeps for about a week.

2.2.2 Para-toluidine solution, 10% (*m/v*).

Place 10 g of para-toluidine in a 100 mL volumetric flask; add 50 mL of *iso*-propanol, CH₃CH(OH)CH₃, and 10 mL of glacial acetic acid, CH₃COOH ($\rho_{20} = 1.05$ g/mL). Make up to 100 mL with *iso*-propanol. This solution should be renewed daily.

2.2.3 Acetaldehyde (ethanal) solution, 1% (*m/v*).

Prepare just before use.

2.2.4 Hydroxymethylfurfural solution, 1 g/L.

Prepare dilutions of the above solution to containing 5, 10, 20, 30 and 40 mg hydroxymethylfurfural/L. The 1 g/L solution and its dilutions must be freshly prepared.

2.3 Procedure

2.3.1 Preparation of sample

- Free sulfur dioxide less than 10 mg/L:

Perform the analysis on 2 mL of wine or must. If necessary filter the wine or must before analysis.

- Free sulfur dioxide greater than 10 mg/L:

15 mL of the test samples are placed in a 25 mL spherical flask with 2 mL acetaldehyde solution (2.2.3). Stir. Wait 15 minutes. Bring to volume with distilled water. Filter if necessary. Perform the analysis on 2 mL of this solution.

2.3.2 Colorimetric determination

Into each of two 25 mL flasks, *a* and *b*, fitted with ground glass stoppers, place 2 mL of the sample prepared as in 2.3.1. Place in each flask 5 mL of paratoluidine solution (2.2.2); mix. Add 1 mL of distilled water to flask *b* (control) and 1 mL barbituric acid (2.2.1) solution to flask *a*, shake to mix. Transfer the contents of the flasks into spectrophotometer cells with optical paths of 1 cm. Zero the absorbance scale at a wavelength of 550 nm using the contents of flask *b*. Follow the variation in the absorbance of the contents of flask *a*; record the maximum value *A*, which is reached after 2 to 5 minutes.

Samples with hydroxymethylfurfural concentrations above 30 mg/L must be diluted before the analysis.

2.3.3 Preparation of the calibration curve

Place 2 mL of each of the hydroxymethylfurfural solutions of 5, 10, 20, 30 and 40 mg/L into two sets of 25 mL flasks, *a* and *b*, and treat them as described in 2.3.2.

The graph representing the variation of absorbance with the hydroxymethylfurfural concentration in mg/L should be a straight line passing through the origin.

2.4 Expression of results

The hydroxymethylfurfural concentration is obtained by plotting on the calibration curve the absorbance determined on the sample analyzed, taking into account any dilution carried out.

The result is expressed in milligrams per liter (mg/L) to one decimal point.

Hydroxymethylfurfural (HMF)

1. Principle of the methods

Separation through a column by reversed-phase chromatography and determination at 280 nm.

Procedures described below are given as examples.

2. High-performance liquid chromatography

2.1 Apparatus

2.1.1 High-performance liquid chromatograph equipped with:

- a loop injector, 5 or 10 μL
- spectrophotometric detector allowing measurement at 280 nm
- column of octadecyl-bonded silica (e.g. Bondapak C₁₈-Corasil, Waters Ass)
- a recorder, preferably an integrator
- Flow rate of mobile phase: 1.5 mL/minute

2.1.2 Membrane filtration system with a pore diameter of 0.45 μm .

2.2 Reagents

2.2.1 Double distilled water

2.2.2 Methanol, distilled or HPLC quality

2.2.3 Acetic acid ($\rho_{20} = 1.05 \text{ g/mL}$)

2.2.4 Mobile phase: water + methanol + acetic acid previously filtered through a 0.45 μm membrane filter, (40 mL + 9 mL + 1 mL)

The mobile phase must be prepared daily and degassed before using.

2.2.5 Hydroxymethylfurfural reference solution, 25 mg/L (*m/v*)

Into a 100 mL volumetric flask, place 25 mg of hydroxymethylfurfural accurately weighed, and bring to volume with methanol. Dilute this solution 1/10 with methanol and filter through a 0.45 μm membrane filter.

If the solution is kept refrigerated in a hermetically sealed brown glass bottle it should keep for two to three months.

2.3 Procedure

Inject 5 (or 10) μL of the sample prepared as described above and 5 (or 10) μL of hydroxymethylfurfural reference solution into the chromatograph. Record the chromatogram.

The retention time of hydroxymethylfurfural is about six to seven minutes.

2.4 Expression of the Results

The hydroxymethylfurfural concentration is expressed in milligrams per liter (mg/L) to one decimal point.

Method OIV-MA-AS315-06

Type II method

Cyanide Derivatives

(Resolution Oeno 4/94)

1. Principle

Free and total hydrocyanic acid is liberated by acid hydrolysis and separated by distillation. After reaction with chloramine T and pyridine, the glutamic dialdehyde formed is determined by colorimetry, due to the blue coloration it gives with 1,3-dimethyl barbituric acid.

2. Equipment

- 2.1. Distillation apparatus: Use the distillation apparatus described for the determination of alcohol in wine.
- 2.2. Round-bottomed 500 mL flask with standard taper joint.
- 2.3. Water bath, thermostated at 20° C.
- 2.4. Spectrophotometer permitting the measurement of absorbance at a wavelength of 590 nm.
- 2.5. Glass cuvette or disposable cuvettes for one use only, with 20 mm optical path.

3. Reagents

- 3.1. Phosphoric acid (H_3PO_4) at 25 p. 100 (w/v)
- 3.2. Solution of chloramine T ($\text{C}_7\text{H}_7\text{ClNNaO}_2\text{S}\cdot 3\text{H}_2\text{O}$) 3% (w/v)
- 3.3. Solution of 1,3-dimethylbarbituric acid: dissolve 3.658 g of 1,3-dimethylbarbituric acid ($\text{C}_6\text{H}_8\text{N}_2\text{O}_3$) in 15 mL of pyridine and 3 mL of hydrochloric acid ($\rho_{20} = 1.19 \text{ g/mL}$) and bring to 50 mL with distilled water.
- 3.4. Potassium cyanide (KCN)
- 3.5. Solution of potassium iodide (KI) 10% (w/v)
- 3.6. Solution of silver nitrate (AgNO_3), 0.1 M

4. Procedure

4.1 Distillation:

In the 500 mL round-bottomed flask (2.2), place 25 mL of wine, 50 mL of

distilled water, 1 mL of phosphoric acid (3.1) and some glass beads. Immediately place the round-bottomed flask on the distillation apparatus. Collect the distillate through a delivery tube connected to a 50 mL volumetric flask containing 10 mL of water. The volumetric flask is immersed in an iced water bath. Collect 30-35 mL of distillate (a total of about 45 mL of liquid in the volumetric flask). Wash the delivery tube with a few milliliters of distilled water, bring the distillate to 20°C and dilute with distilled water to the mark.

4.2 Measurement:

Place 25 mL of distillate in a 50 mL glass-stoppered Erlenmeyer flask, add 1 mL of chloramine T solution (3.2) and stopper tightly. After exactly 60 seconds, add 3 mL of 1,3-dimethylbarbituric acid solution (3.3), stopper tightly and let stand for 10 minutes. Then measure the absorbance relative to the reference blank (25 mL of distilled water instead of 25 mL of distillate) at a wavelength of 590 nm in cuvettes of 20 mm optical path.

5. Establishing the standard curve

5.1 Argentimetric titration of potassium cyanide.

In a 300 mL volumetric flask, dissolve about 0.2 g of KCN (3.4) precisely weighed in 100 mL of distilled water. Add 0.2 mL of potassium iodide solution (3.5) and titrate with the solution of 0.1 M silver nitrate (3.6) until obtaining a stable yellowish color.

In calculating the concentration of KCN in the sample, 1 mL of 0.1 M silver nitrate solution corresponds to 13.2 mg of KCN.

5.2 Standard Curve.

5.2.1. Preparation of the standard solutions:

Knowing the KCN concentration determined in accordance with 5.1, prepare a standard solution containing 30 mg/L of hydrocyanic acid (30 mg HCN = 72.3 mg of KCN). Dilute this solution to 1/10.

Introduce 1.0, 2.0, 3.0, 4.0, and 5.0 mL of the diluted standard solution in 100 mL volumetric flasks and bring to the mark with distilled water. The prepared standard solutions correspond to 30, 60, 90, and 150 µg/L of hydrocyanic acid, respectively.

5.2.2. Determination:

Using 25 mL of the solutions, continue as indicated above in 4.1 and 4.2.

The values obtained for the absorbance with these standard solutions, reported according to the corresponding levels of hydrocyanic acid, form a line passing through the origin.

6. Expression of the results

Hydrocyanic acid is expressed in micrograms per liter ($\mu\text{g/L}$) without decimal.

6.1. Calculation:

Determine the concentration of hydrocyanic acid from the standard curve. If a dilution was done, multiply the result by the dilution factor.

Repeatability (r) and Reproducibility (R)

White wine: $r = 3.1 \mu\text{g/L}$ i.e. approximately 6% . X_i
 $R = 12 \mu\text{g/L}$ i.e. approximately 25% . X_i

Red wine: $r = 6.4 \mu\text{g/L}$ i.e. approximately 8% . X_i
 $R = 23 \mu\text{g/L}$ i.e. approximately 29% . X_i

X_i = average concentration of HCN in the wine.

BIBLIOGRAPHY

- 1) JUNGE C., Feuillet vert N° 877 (1990)
- 2) ASMUS E. GARSCHLAGEN H., Z Anal. Chem. 138, 413-422 (1953)
- 3) WÜRDIG G., MÜLLER TH., Die Weinwissenschaft 43, 29-37 (1988)

Examination of artificial sweeteners

1. Principle of the methods

Examination of saccharine (benzoic sulfimide), Dulcin (*p*-ethoxyphenylurea), cyclamate (cyclohexylsulfamate) and P-4000 (5-nitro-2-propoxyaniline or 1-propoxy-2-amino-4-nitrobenzene).

After concentration of the wine, the saccharine, Dulcin and P-4000 are extracted in an acid medium with benzene; the cyclamate is extracted from the wine after the benzene extraction using ethyl acetate (the order of extraction is important). The residues after solvent evaporation are submitted to thin layer chromatography.

Saccharine and cyclamate are identified by chromatography on cellulose plates (solvent: acetone-ethyl acetate-ammonium hydroxide), the first the benzene extract, the second in the extract by the ethyl acetate after purification by washing with ether.

These sweeteners are developed by spraying with a solution of benzidine; aniline; cupric acetate, and have the following Rf: 0.29 for cyclamate, 0.46 for saccharine.

The P-4000 and Dulcin from the benzene extract are separated by chromatography on polyamide plates, (solvent: toluene; methanol; glacial acetic acid). These sweeteners are developed by spraying a solution of *p*-dimethylaminobenzaldehyde, and have the following Rf: 0.60 for Dulcin, 0.80 for P-4000.

2. Method

Examination of saccharine, cyclamate, Dulcin and the P-4000.

2.1 Apparatus

- 2.1.1 Chromatography tank
- 2.1.2 Micrometry syringes or micropipettes
- 2.1.3 Separator tube 15 mm in diameter and 180 mm long, with a stopcock
- 2.1.4 Water bath at 100°C
- 2.1.5 Regulatable oven, able to reach 125°C

2.2 Reagents

- 2.2.1 Extraction solvent:

- Benzene
- Ethyl acetate

2.2.2 Chromatography solvents:

Mixture No.1:

Acetone	60 parts
Ethyl acetate	30 parts
Ammonium hydroxide ($\rho_{20}= 0.92$ g/mL)	10 parts

Mixture No 2.:

Toluene	90 parts
Methanol	10 parts
Glacial acetic acid ($\rho_{20}= 1.05$ g/mL)	10 parts

2.2.3. Chromatography plates (20 x 20 cm):

- with layer of cellulose powder (for ex., Whatman CC 41 or Macherey-Nagel MN300)
- with layer of polyamide powder (for ex., Merck)

2.2.4 Indicating reagent for saccharine and cyclamate

Prepare:

- alcoholic solution of benzidine at 250 mg in 100 mL ethanol
- saturated solution of cupric acetate, $\text{Cu}(\text{C}_2\text{H}_3\text{O}_2)_2 \cdot \text{H}_2\text{O}$
- freshly distilled aniline

Mix: 15 mL of benzidine solution, 1 mL of aniline and 0.75 mL saturated cupric acetate solution.

This solution must be freshly prepared. It corresponds to the volume required for development of a 20 x 20 cm plate.

2.2.5 Hydrochloric acid 50% (v/v),

2.2.6 Nitric acid solution, 25% (v/v),

2.2.7 Indicator reagent for the P-4000 and Dulcin: dissolve 1 g of 1,4-paradimethylaminobenzaldehyde in 50 mL methanol; add 10 mL 25% nitric acid; bring to 100 mL with methanol. Use 15 mL of this reagent for the development of a 20 x 20 cm plate.

2.2.8 Cyclo-hexylsulfamic acid in water-ethanol solution, 0.10 g/100 mL

Dissolve 100 mg of the sodium or calcium salt of cyclo-hexylsulfamic acid in 100 mL of an equal part mixture of water and ethanol.

2.2.9 Saccharine aqueous solution, 0.05 g/100 mL

2.2.10 Dulcin, 0.05 g/100 mL of methanol.

2.2.11 P-4000, 0.05 g/100 mL of methanol.

2.3 Procedure

2.3.1 Extraction

100 mL of wine, placed in a beaker, are rapidly evaporated by boiling until the volume is reduced to 30 mL, while directing a current of cold air to the surface of the flask. Allow to cool. Acidify with 3 mL 50% hydrochloric acid (v/v). Transfer to a 500 mL conical flask with a ground stopper, add 40 mL of benzene and stir with a mechanical stirrer for 30 min. Transfer to a separating funnel to separate the organic phase. If an emulsion is formed, it must be separated by centrifugation. Place the organic phase in a conical flask with a ground glass stopper.

Decant the wine previously extracted with benzene, which corresponds to the lower layer in the separating funnel, into a 500 mL conical flask with a ground stopper containing 40 mL of ethyl acetate. Agitate for 30 minutes and separate the organic phase as before taking care to recover only the organic fraction and not the wine.

On a 100°C water bath, evaporate each extraction solvent in 50-60 mm diameter evaporation dishes, in small amounts while directing a stream of cold air on the surface of the dishes. Continue the evaporation until the residue has a syrupy consistency, stopping before the evaporation is complete.

Re-dissolve the benzene extract residue in the evaporation dish with 0.5 mL ethanol-water (1:1) solution (it is advisable to re-dissolve the residue once with 0.25 mL ethanol-water solution and then to rinse the dish with another portion of 0.25 mL of the same solution). Place the ethanol-water extract into a small tube with a ground stopper (extract B).

The residue of the dish in which the ethyl acetate (containing the cyclamate) has been evaporated, is dissolved with 0.5 mL of water and is poured into a small separator tube. Wash the dish with 10 mL ether and add the ether to the contents of the separator tube. Mix vigorously for 2 minutes and separate the lower layer into a small test tube that contains 0.5 mL ethanol. This comprises a total of 1 mL of ethanol-water solution that contains the possible cyclamate (extract A).

2.3.2 Chromatography

2.3.2.1 Saccharine and cyclamate

For examination of the saccharine and cyclamate, use a cellulose plate, with half of the plate for the identification of cyclamate and the other half for saccharine.

To do this, spot 5 to 10 µL of extract A and 5 µL of the standard cyclamate solution. On the second part of the plate spot 5 to 10 µL of extract B and 5 µL of the standard saccharine solution. Place the prepared plate in the chromatography bath containing solvent No.1 (acetone; ethyl acetate;

ammonium hydroxide); allow to migrate until the solvent front reaches 10 to 12 cm. Remove the plate from the bath and dry with warm air. Spray the plate evenly and gently with the benzidine reagent (17-18 mL for each plate). Dry the plate with cold air. Place the plate in an oven maintained at 120-125°C for 3 minutes. The spots appear dark gray on a light chestnut background; they turn brownish with time.

2.3.2.2 *P-4000 and Dulcin*

Deposit 5 µL of extract B and 5 µL of the standard solutions of Dulcin and P-4000 on a polyamide plate. Place the prepared plate in the chromatography tank containing solvent No. 2 (toluene; methanol; acetic acid). Let the solvent front reach a height of 10 to 12 cm.

Remove the plate from the tank; dry in cold air. Spray with 15 mL of the *p*-dimethylaminobenzaldehyde reagent, then dry with cold air until the orange-yellow colored spots appear which correspond to Dulcin and P-4000.

2.3.2.3 *Sensitivity*

The benzidine reagent allows detection of spots corresponding to 2 µg of saccharine and 5 µg of cyclamate. The *p*-dimethylaminobenzaldehyde reagent reveals 0.3 µg of Dulcin and 0.5 µg of P-4000.

This method allows determination of (depending upon the efficiency of the extractions):

Saccharine	2-3 mg/L
Cyclamate	40-50 mg/L
DULCIN	1 mg/L
P-4000	1-1.5 mg/L

BIBLIOGRAPHY

- TERCERO C., *F.V., O.I.V.*, 1968, n° 277 and *F.V., O.I.V.*, 1970, n° 352.
- Wine Analysis Commission of the Federal Health Department of Germany, 1969, *F.V., O.I.V.*, n° 316.
- International Federation of Fruit Juice Manufacturers, 1972, *F.V., O.I.V.*, n° 40.
- SALO T., ALRO E. and SALMINEN K., *Z. Lebensmittel Unters. u. Forschung*, 1964, **125**, 20.

Examination of artificial sweeteners

1. Principle of the methods

Examination of saccharine, Dulcin and cyclamate.

These sweeteners are extracted from wine using a liquid ion exchanger, then re-extracted with dilute ammonia hydroxide, and are separated by thin layer chromatography using a mixture of cellulose powder and polyamide powder (solvent: xylene; *n*-propanol; glacial acetic acid; formic acid). These sweeteners have a blue fluorescence on a yellow background under ultraviolet light after spraying with a 2,7-dichlorofluorescein solution.

Subsequent spraying with 1,4-dimethylaminobenzaldehyde solution allows differentiation of Dulcin, which gives only one orange spot, from vanillin and the esters of *p*-hydroxybenzoic acid which migrate with the same R_f.

2. Method

Examination of saccharine, cyclamate and Dulcin.

2.1 Apparatus

2.1.1 Apparatus for expression by thin layer

2.1.2 Glass plate 20 x 20 cm

Preparation of the plates: mix thoroughly 9 g of dry cellulose powder and 6 g of polyamide powder. Add, while stirring, 60 mL methanol. Spread on the plates to a thickness of 0.25 mm. Dry for 10 minutes at 70°C. The quantities prepared are sufficient for the preparation of 5 plates.

2.1.3 Water bath with a temperature regulator or a rotary evaporator,

2.1.4 UV lamp for examination of the chromatography plates.

2.2 Reagents

2.2.1 Petroleum ether (40-60°)

2.2.2 Ion exchange resin, for example: Amberlite LA-2

2.2.3 Acetic acid diluted to 20% (v/v)

2.2.4 Ion exchange solution: 5 mL of ion exchanger is vigorously agitated with 95 mL petroleum ether and 20 mL of 20% acetic acid. Use the upper phase.

2.2.5 Nitric acid in solution, 1 M

2.2.6 Sulfuric acid, 10 % (v/v)

2.2.7 Ammonium hydroxide diluted to 25% (v/v)

2.2.8 Polyamide powder, for example: Macherey-Nagel or Merck

2.2.9 Cellulose powder, for example: Macherey-Nagel MN 300 AC

2.2.10 Solvent for chromatography:

Xylene	45 parts
<i>n</i> -Propanol	6 parts
Glacial acetic acid ($\rho_{20} = 1.05$ g/mL)	7 parts
Formic acid 98-100%	2 parts

2.2.11 Developers:

- solution of 2,7-dichlorofluorescein, 0.2 % (m/v), in ethanol,
- solution of 1,4-dimethylaminobenzaldehyde: dissolve 1 g of dimethylaminobenzaldehyde placed in a 100 mL volumetric flask with about 50 mL ethanol. Add 10 mL of nitric acid, 25% (v/v), and bring to volume with ethanol.

2.2.12 Standard solution:

- solution of Dulcin, 0.1 % (m/v), in methanol,
- solution of saccharine at 0.1 g per 100 mL in a mixture of equal parts methanol and water,
- cyclamate solution: solution containing 1 g of the sodium or calcium salt of cyclohexylsulfamic acid in 100 mL of a mixture of equal parts methanol and water,
- solution of vanillin at 1 g /100 mL in a mixture of equal parts methanol and water,
- solution of the ester of *p*-hydroxybenzoic acid at 1 g /100 mL in methanol.

2.3 Procedure:

50 mL of wine is placed in a separatory funnel, acidified with 10 mL dilute sulfuric acid (2.2.6) and extracted with two aliquots of the ion exchange solution using 25 mL each time. The 50 mL of ion exchange solution is washed three times using 50 mL of distilled water each time, which is discarded, then three times with 15 mL of dilute ammonium hydroxide (2.2.7). The ammonia solutions recovered are then carefully evaporated at 50°C until dry on a water bath or in a rotary evaporator. The residue is recovered with 5 mL of acetone and 2 drops 1 M nitric acid solution, filtered, and again

evaporated dry at 70°C on a water bath. It is necessary to avoid heating for too long and above 70°C. The residue is recovered with 1 mL of methanol.

5 to 10 µL of this solution and 2 µL of the standard solutions are spotted on the plate. Let the solvent migrate (xylene: *n*-propanol: acetic acid: formic acid) (2.2.10) to a height of about 15 cm, which takes about 1 hour.

After air-drying, the dichlorofluorescein solution is thoroughly sprayed on the plate. The saccharine and the cyclamate appear immediately as light spots on a salmon colored background. Under examination in ultraviolet light (254 or 360 nm), the three sweeteners appear as a fluorescent blue on a yellow background.

The sweeteners separate, from the bottom to the top of the plate, in the following order: cyclamate, saccharine, Dulcin.

The vanillin and the esters of *p*-hydroxybenzoic acid migrate with the same R_f as the Dulcin. To identify Dulcin in the presence of these substances, the plate then must be sprayed with a solution of dimethylaminobenzaldehyde. The Dulcin appears as an orange spot, whereas the other substances do not react.

Sensitivity - The quantity limitation shown on the chromatography plate is 5 µg for the three substances.

This method permits detection of:

- Saccharin 10 mg/L
- Cyclamate 50 mg/L
- Dulcin 10 mg/L

BIBLIOGRAPHY

- TERCERO C., *F.V., O.I.V.*, 1968, n° 277 and *F.V., O.I.V.*, 1970, n° 352.
- Wine Analysis Commission of the Federal Health Department of Germany, 1969, *F.V., O.I.V.*, n° 316.
- International Federation of Fruit Juice Manufacturers, 1972, *F.V., O.I.V.*, n° 40.
- SALO T., ALRO E. and SALMINEN K., *Z. Lebensmittel Unters. u. Forschung*, 1964, **125**, 20.

Examination of artificial colorants

1. Principle

The wine is concentrated to 1/3 its original volume, made alkaline with a solution of dilute sodium hydroxide and extracted with ether. The ether phase, after being washed with water, is extracted with a dilute acetic acid solution; this acetic solution, alkalinized with ammonia, is brought to boiling in the presence of a piece of wool thread treated with aluminum sulfate and potassium tartrate. The colorant, if any, is fixed on the wool. The wool on which it is fixed is then placed in a dilute acetic acid solution. After evaporation of the acetic solution, the residue is recovered with a water-alcohol solution and analyzed by thin layer chromatography for characterization of the colorant.

The aqueous phase remaining after the ether extraction contains the acid colorants that may be present. They are extracted by using their affinity for animal fibers that markedly absorb the color: they are fixed on a wool plug in a mineral acid medium.

To concentrate the coloring material, carry out a double fixation and/or several successive fixations on increasingly smaller wool plugs.

Coloring of the wool plug indicates that an artificial colorant was added to the wine; the colorant is then identified by thin layer chromatography.

2. Apparatus

- 2.1 20 x 20 glass plates covered with cellulose powder,
- 2.2 Chromatography tank

3. Reagents

- 3.1 Ethyl ether
- 3.2 Sodium hydroxide solution, 5% (*m/v*)
- 3.3 Glacial acetic acid ($\rho_{20} = 1.05$ g/mL)
- 3.4 Dilute acetic acid, containing one part glacial acetic acid to 18 parts water
- 3.5 Dilute hydrochloric acid: to one part hydrochloric acid ($\rho_{20} = 1.19$ g/mL), add 10 parts distilled water
- 3.6 Ammonium hydroxide ($\rho_{20} = 0.92$ g/mL)
- 3.7 White wool threads, previously washed, degreased with ether and dried
- 3.8 White wool threads, previously washed, degreased with ether, dried and acidified

Acidulant: Dissolve 1 g crystallized aluminum sulfate $\text{Al}_2(\text{SO}_4)\cdot 18\text{H}_2\text{O}$ and 1.2 g acid potassium tartrate in 500 mL water. Place 10 g of the white wool threads, previously washed, degreased with ether and dried in the solution and stir about 1 hour. Let stand 2 to 3 hours; drain, let dry at room temperature.

3.9 Solvent No.1 for chromatography of colorants with basic characteristics:

<i>n</i> -Butanol	50 mL
Ethanol	25 mL
Acetic acid ($\rho_{20} = 1.05 \text{ g/mL}$)	10 mL
Distilled water	25 mL

3.10 Solvent No.2 for chromatography of colorants with acidic characteristics:

<i>n</i> -Butanol	50 mL
Ethanol	25 mL
Ammonium hydroxide ($\rho_{20} = 0.92 \text{ g/mL}$)	10 mL
Distilled water	25 mL

4. Procedure

4.1 *Examination of colorants with basic characteristics.*

4.1.1 Extraction of the coloring materials.

Place 200 mL of wine in a 500 mL glass conical flask and boil until reduced to 1/3 its volume.

After cooling, neutralize with 5% sodium hydroxide solution until the natural color of wine shows a marked change.

Extract twice using 30 mL ether. The ether phases are recovered, containing basic colorants to be determined; the extraction residue must be saved for the analysis of acidic colorants.

Wash the extracted ether twice with 5 mL of water to eliminate the sodium hydroxide; mix with 5 mL dilute acetic acid. The acidic aqueous phase obtained is colored in the presence of a basic colorant.

The presence of the colorant may be confirmed by fixation on acidified wool. Make the acidic aqueous phase obtained alkaline using 5% ammonia. Add 0.5 g acidified wool and boil for about 1 minute. Rinse the wool under running water. If the wool is colored, the wine contains some basic colorant.

4.1.2 Characterization by thin-layer chromatography.

The aqueous acetic phase containing the basic colorant is concentrated to 0.5 mL. If the colorant is fixed on the acidic wool, the wool plug is treated by boiling with 10 mL distilled water and a few drops of acetic acid ($\rho_{20} = 1.05 \text{ g/mL}$). Remove the wool fragment after wringing out liquid. Concentrate the solution to 0.5 mL.

Deposit 20 μL of this concentrated solution on the cellulose plate 3 cm from the lateral edge and 2 cm from the lower edge of the plate.

Place the plate in the tank containing solvent No.1 so that the lower edge is immersed in the solvent to a depth of 1 cm.

When the solvent front has migrated to a height of 15 to 20 cm, remove the plate from the tank. Allow to air dry.

Identify the colorant by means of a solution of known artificial colorants of basic characteristics deposited simultaneously on the chromatogram.

4.2 *Examination of colorants with acidic characteristics*

4.2.1 Extraction of the coloring material.

Use the residue from the wine used for examining colorants with basic characteristics, concentrated to 1/3 and neutralized after extraction with ether.

If the first part of the procedure has not been conducted, start with 200 mL wine, place in a conical flask, boil until reduced to 1/3.

In either case, add 3 mL of dilute hydrochloric acid and 0.5 g of white wool: boil for 5 minutes, decant the liquid and wash the wool under running water.

In the conical flask which contains the wool, add 100 mL water and 2 mL dilute hydrochloric acid; boil for 5 minutes, separate the acidic liquid and repeat this procedure until the liquid used to wash is colorless.

After the wool has been thoroughly washed to eliminate the acid completely, recover in a conical flask with 50 mL distilled water and a few drops of ammonium hydroxide ($\rho_{20} = 0.92 \text{ g/mL}$): bring to a gentle boil for 10 minutes in order to dissolve any artificial coloring matter fixed on the wool.

Remove the wool from the flask, bring the liquid volume to 100 mL and boil until the ammonia completely evaporates. Acidify with 2 mL of dilute hydrochloric acid (check that the reaction of the liquid is definitely acidic by placing 1 drop of this liquid on indicator paper).

Add to the flask 60 mg (about 20 cm of standard thread) of white wool and boil for 5 minutes; remove the wool and rinse it under running water.

If, after this procedure, the wool is colored red, when it involves red wine, or yellow if it pertains to white wine, the presence of artificial organic coloring matter of an acidic nature is proven.

If the color is weak or uncertain, repeat the ammonia treatment and do a second fixation using a 30 mg wool thread.

If, during the course of the second fixation a weak but distinct pink color is obtained, assume the presence of an acidic colorant.

If necessary for a more definite determination, carry out new fixations-elutions (up to 4 or 5) using a procedure identical to that used for the second fixation until a faint but distinct pink color is obtained.

4.2.2 Characterization by thin layer chromatography.

The plug of colored wool is treated by boiling with 10 mL distilled water and few drops of ammonium hydroxide ($\rho_{20} = 0.92 \text{ g/mL}$). Recover the piece of wool after wringing. Concentrate the ammonium hydroxide solution to 0.5 mL.

Deposit 20 μL of this solution on a cellulose plate to within 3 cm of the lateral edge and 2 cm of the lower edge of the plate.

Put the plate in place in the tank so that the lower edge is immersed in the solvent to a depth of 1 cm.

When the solvent front has migrated to a height of 15 to 20 cm, remove the plate from the tank and let dry in the air.

Identify the colorant by means of known artificial coloring solutions deposited simultaneously on the chromatogram.

BIBLIOGRAPHY

TERCERO C., *F.V., O.I.V.*, 1970, n° 356.

ARATA P., SAENZ-LASCANO-RUIZ, Mme I., *F.V., O.I.V.*, 1967, n° 229.

Method OIV-MA-AS315-09

Type IV method

Diethylene glycol
(2-hydroxy-ethoxyethanol)

1. Objective

The detection of diethylene glycol, HOCH₂CH₂OCH₂CH₂OH, in wine where its concentration is equal to or greater than 10 mg/L.

2. Principle

Separation of diethylene glycol from other constituents in wine by gas chromatography using a capillary column, after extraction with ether.

Note: The operating conditions described below are provided as an example.

3. Apparatus

3.1 Gas chromatograph equipped with:

- split-splitless injector,
- flame ionization detector,
- capillary column coated with a film of polyethyleneglycol (Carbowax 20 M), 50 m x 0.32 mm I.D.

Operating conditions:

Injector temperature: 280°C.

Detector temperature: 270°C.

Carrier gas: hydrogen.

Flow rate of carrier gas: 2 mL/min.

Flow rate: 30 mL/min.

Injection: splitless.

Injection volume: 2 µL.

Injection 35°C - flow closed after 40 seconds.

Temperature program: 120°C to 170°C at 3°C/min.

3.2 Centrifuge

4. Reagents

4.1 1,3-propanediol, 1 g/L, in alcohol, 20% (v/v), (internal standard).

4.2 Aqueous solution of diethyleneglycol 20 mg/L.

5. Procedure

Into a 50 mL flask, place:

- 10 mL of wine
- 1 mL of 1,3-propanediol solution
- 25 mL diethyl ether.

Shake and add sufficient quantity of neutral potassium carbonate to saturate the mixture. Shake. Separate the two phases by centrifugation.

Carry out a second extraction. Eliminate the diethyl ether by evaporation and recover the residue with 5 mL ethanol.

The yield of the extraction must be at least 90%.

Carry out the chromatography according to the conditions given in 3.1.

6. Results

The diethylene glycol is identified by comparing its retention time to the time of the reference solution, analyzed under the same conditions as the wine.

The amount is determined by comparison to the reference solution using the internal standard method.

It is recommended, if the concentration is equal to or less than 20 mg/l, to confirm the presence by mass spectrometry.

BIBLIOGRAPHY

BANDION F., VALENTA M. & KOHLMANN H., *Mitt. Klosterneuburg, Rebe und Wein*, 1985, **35**, 89.

BERTRAND A., *Conn. vigne vins*, 1985, **19**, 191.

Laboratoire de la répression des fraudes et du contrôle de la qualité de Montpellier, *F.V., O.I.V.*, 1986, n° 807.

**Measuring ochratoxine A in wine
after going through an immunoaffinity column
and HPLC with fluorescence detection**

(Oeno 16/2001 revised by Oeno 349-2011)

1. FIELD OF APPLICATION

This document describes the method used for determining ochratoxine A (OTA) in red, rosé, and white wines, including special wines, in concentrations ranging up to 10 µg/l using an immunoaffinity column and high performance liquid chromatography (HPLC) [1].

This method was validated following an international joint study in which OTAs were measured in white and red wines during the analysis of naturally contaminated wines and wines with toxins ranging from 0.01 µg/l to 3.00 µg/l.

This method can apply to semi-sparkling wines and sparkling wines as long as the samples have been degassed beforehand, through sonication, for example.

2. PRINCIPLE

Wine samples are diluted with a solution containing polyethylene glycol and sodium hydrogen carbonate. This solution is filtered and purified on the immunoaffinity column.

OTA is eluted with methanol and quantified by HPLC in inverse state with fluorimetric detection.

3. REAGENTS

3.1 Reagents for separation of the OTA on an immunoaffinity column

The reagents listed below are examples. Suppliers of immunoaffinity columns may offer dilution solutions and eluents suitable for their products. If so, it is preferable to use these products.

3.1.1 Sodium hydrogen phosphate dihydrate ($\text{Na}_2\text{HPO}_4 \cdot 2\text{H}_2\text{O}$) CAS [10028-24-7]

3.1.2 Sodium dihydrogen phosphate monohydrate ($\text{NaH}_2\text{PO}_4 \cdot \text{H}_2\text{O}$) CAS [10049-21-5]

3.1.3 Sodium chloride (NaCl) CAS [7647-14-5]

3.1.4 Purified water for laboratories, for example EN ISO 3696 quality (water for analytical laboratory use – Specification and test method [ISO 3696:1987]).

3.1.5 Phosphate buffer (dilution solution)

Dissolve 60g of Na₂HPO₄·2H₂O (3.1.1) and 8.8g of NaH₂PO₄·H₂O (3.1.2) in 950ml of water and add more water to make up to 1 litre.

3.1.6 Phosphate buffer saline (washing solution)

Dissolve 2.85g of Na₂HPO₄·2H₂O (3.1.1), 0.55g of NaH₂PO₄·H₂O (3.1.2) and 8.7g of NaCl in 950ml of water and add more water to make up to 1 litre.

3.1.7 Methanol (CH₃OH) CAS [67-56-1]

3.2 Reagents for HPLC

3.2.1 Acetonitrile for HPLC (CH₃CN) CAS [75-05-8]

3.2.2 Glacial acetic acid (CH₃COOH) CAS [64-19-7]

3.2.3 Mobile phase: water: acetonitrile: glacial acetic acid, 99:99:2, v/v/v

Mix 990 ml of water with 990 ml of acetonitrile (3.2.2) and 20 ml of glacial acetic acid (3.2.3). In the presence of undissolved components, filter through a 0.45µm filter. Degas (with helium, for example) unless the HPLC equipment used includes a degassing step.

3.3 Reagents for the preparation of the OTA stock solution

3.3.1 Toluene (C₆H₅CH₃) CAS [108-88-3]

3.3.2 Mixture of solvents (toluene: glacial acetic acid, 99:1, v/v).

Mix 99 parts in volume of toluene (3.3.1) with one part volume of glacial acetic acid (3.2.2).

3.4 OTA stock solution

Dissolve 1 mg of OTA or the same content in a bulb, if the OTA was obtained in the form of film after evaporation, in the solvent mixture (3.12) to obtain a solution containing approximately 20 to 30 µg/ml of OTA.

To determine the exact concentration, record the absorption spectrum between 300 and 370 nm in a quartz space with 1 cm of optical path while using the solvent mixture (3.12) as a blank. Identify maximum absorption and calculate the concentration of OTA (*c*) in µg/ml by using the following equation:

$$c = A_{\max} \times M \times 100 / \epsilon \times \delta$$

In which:

A_{\max} = Absorption determined by the longest maximum wave (about 333 nm)

M = OTA molecular mass = 403,8 g/mole

ϵ = coefficient d'extinction molaire de l'OTA dans le mélange de solvant (3.12) ($\epsilon = 544/\text{mole}$)

δ = optical pathway (cm)

This solution is stable at -18°C for at least 4 years.

3.5 Standard OTA solution (2 $\mu\text{g}/\text{ml}$ in toluene: acetic acid, 99:1, v/v)

Dilute the stock solution (3.13) with the solvent mixture (3.12) to obtain a standard solution of OTA with a concentration of 2 $\mu\text{g}/\text{ml}$.

This solution can be stored at $+4^{\circ}\text{C}$ in a refrigerator. The stability should be tested regularly.

4. EQUIPMENT

Usual laboratory equipment and in particular, the following equipment:

4.1 Glass tubes (4 ml)

4.2 Vacuum pump to prepare the immunoaffinity columns.

4.3 Reservoir and flow tube adapted to immunoaffinity columns.

4.4 Fibre glass filters (for example Whatman GF/A).

4.5 Immunoaffinity columns specifically for OTA.

The column should have the total link capacity of at least 100 ng OTA. This will allow for a purification yield of at least 85% when a diluted solution of wine containing 100 ng OTA is passed through.

4.6 Rotating evaporator

4.7 Liquid chromatography, a pump capable of attaining a constant flow of 1 ml/min isocratic, as with the mobile phase.

4.8 Injection system must be equipped with 100 μl loop.

4.9 Column of analytical HPLC in steel 150×4.6 mm (i.d.) filled with a stationary phase C_{18} (5 μm) preceded with a pre-column or a pre-filter (0,5 μm) containing an appropriate phase. Different size columns can be used provided that they guarantee a good base line and background noise enabling the detection of of OTA peaks, among others.

4.10 Fluorescence detector is connected to the column and the excitation wavelength is set at 333 nm and the emitting wavelength at 460 nm.

4.11 Information retrieval system

4.12 U.V. spectrometer

5. PROCEDURE

5.1 Preparation of samples

Pour 10 ml of wine in a 100 ml conical flask. Add 10 ml of the dilution solution (3.8). Mix vigorously. Filter through fibreglass filter (4.4). Filtration is necessary for cloudy solutions or when there is precipitation after dissolving.

5.2 Purification by immunoaffinity column

Set up the by immunoaffinity column (4.5) to the vacuum pump (4.2), and attach the reservoir (4.3).

Add 10 ml (equivalent to 5 ml of wine) of the diluted solution in the reservoir. Put this solution through the immunoaffinity column at a flow of 1 drop per second. The immunoaffinity column should not become dry. Wash the immunoaffinity column with 5 ml of cleaning solution (3.9) and then with 5 ml of water at a flow of 1 to 2 drops per second.

Blow air through to dry column. Elute OTA in a glass flask (4.1) with 2 ml of methanol (3.4) at the rate of 1 drop per second. Evaporate the eluate to dryness at 50° C with nitrogen. Dissolve again immediately in 250 µl of the HPLC mobile phase (3.10) and keep at 4° C until the HPLC analysis.

5.3 HPLC analysis

Using the injection loop, inject 100 µl of reconstituted extract (equivalent to 2 ml of wine) in the chromatography.

Operating conditions

Flow: 1 ml /min.

Mobile phase: acetonitrile: water: glacial acetic acid (99:99:2, v/v/v)

Fluorescence detector: Excitation wavelength = 333 nm

Emitting wavelength = 460 nm

Volume of injection: 100 µl

6. QUANTIFICATION OF OCHRATOXINE A (OTA)

The quantification of OTA should be calculated by measuring the area or the height of the peaks at the OTA retention time and compared to the calibration curve

6.1 Calibration curve

**COMPENDIUM OF INTERNATIONAL METHODS OF ANALYSIS - OIV
Ochratoxin A**

Prepare a calibration curve daily and every time chromatographical conditions change. Measure out 0.5 ml of the standard OTA solution (3.14) at 2 µg/ml in a glass flask and evaporate the solvent using nitrogen.

Dissolve again in 10 ml in the HPLC mobile phase (3.10) which was previously filtered using a 0.45 µm filter. This produces an OTA of 100 ng/ml solution.

Prepare 5 HPLC calibration solutions in five 5 ml graduated flasks following Table 1.

Complete each 5 ml standard solution with HPLC mobile phase. (3.10).

Inject 100 µl of each solution in the HPLC.

Table 1

	Std 1	Std 2	Std 3	Std 4	Std 5
µl of mobile phase filtered HPLC (3.10)	4970	4900	4700	4000	2000
µl of OTA solution at 100 ng/ml:	30	100	300	1000	3000
OTA concentration (ng/ml)	0.6	2.0	6.0	20	60
Injected OTA (ng)	0.06	0.20	0.60	2.00	6.00

NOTE:

1. *If the quantity of OTA in the samples is outside the calibration range, an appropriate dilution should occur or smaller volumes should be injected. In these cases, the final (7) should be reviewed on a case by case basis.*

2. *Due to the great variations in concentrations, it is recommended to pass the linear calibration by zero in order to obtain an exact quantification for low concentrations of OTA. (less than 0.1 µg/l)*

7. CALCULATIONS

Calculate the quantity of OTA in the aliquot of the solution testes and injected in the HPLC column.

Calculate the concentration of OTA (C_{OTA}) in ng/ml (equivalent to µg/l) by using the following formula:

$$C_{OTA} = M_A \times F/V_1 \times V_3/V_2$$

Where:

M_A is the volume of ochratoxin A (in ng) in the aliquot part of the template injected on the column and evaluated from the calibration curve.

F is the dilution factor

**COMPENDIUM OF INTERNATIONAL METHODS OF ANALYSIS - OIV
Ochratoxin A**

V_1 is the sample volume to be analysed (10 ml)

V_2 the volume of the solution tested and injected in the column (100 μ l)

V_3 is the volume of solution used to dissolve the dry eluate (250 μ l)

8. PERFORMANCES USING THIS METHOD IN LABORATORIES

Table 2 regroups performances of the method applied to white, rosé and red wines in laboratories participating in the validation of this method.

Table 2. Recovery of ochratoxin A from wines overweighted with different concentrations of added ochratoxin A

Addition (μ g/l)	Red wine		Rosé wine		White wine	
	Yield \pm SD* (%)	RSD# (%)	Yield \pm SD* (%)	RSD# (%)	Yield \pm SD* (%)	RSD# (%)
0.04	96.7 \pm 2.2	2.3	94.1 \pm 6.1	6.5	91.6 \pm 8.9	9.7
0.1	90.8 \pm 2.6	2.9	89.9 \pm 1.0	1.1	88.4 \pm 0.2	0.2
0.2	91.3 \pm 0.6	0.7	88.9 \pm 2.1	2.4	95.1 \pm 2.4	2.5
0.5	92.3 \pm 0.4	0.5	91.6 \pm 0.4	0.4	93.0 \pm 0.2	0.2
1.0	97.8 \pm 2.6	2.6	100.6 \pm .,5	2.5	100.7 \pm 1.0	1.0
2.0	96.5 \pm 1.6	1.7	98.6 \pm 1.8	1.8	98.0 \pm 1.5	1.5
5.0	88.1 \pm 1.3	1.5	-	-	-	-
10,0	88,9 \pm 0,6	0,7	-	-	-	-
Average of averages	92.8 \pm 3.5	3.8	94.5 \pm 5.2	5.5	94.5 \pm 4.1	4.3

* SD = Spread type (Standard deviation) (n = 3 replicates) ;

RSD = Relative spread type (Variation percentage).

9. GROUP WORK

The method was validated by a group study with the participation of 16 laboratories in 8 countries, following the protocol recommendations harmonised for validating the analysis methods. [2]. Each participant analysed 10 white wines, 10 red wines, representing 5 random duplicate wines; naturally contaminated or with OTA added. The performances of the method which resulted from this work are found in appendixes I and II, outlining critical points of the method are found in appendix III.

10. PARTICIPATING LABORATORIES

Unione Italiana Vini, Verona	ITALY
Istituto Sperimentale per l'Enologia, Asti	ITALY
Istituto Tecnico Agraria, S. Michele all'Adige (TN)	ITALY
Università Cattolica, Piacenza	ITALY
Institute for Health and Consumer Protection, JRC – Ispra	ITALY
Neutron s.r.l., S. Maria di Mugnano (MO)	ITALY
Chemical Control s.r.l., Madonna dell'Olmo (CN)	ITALY
Laboratoire Toxicologie Hygiène Appliquée, Université V. Segalen, Bordeaux	FRANCE
Laboratoire de la D.G.C.C.R.F. de Bordeaux, Talence	FRANCE
National Food Administration, Uppsala	SWEDEN
Systembolagets Laboratorium, Haninge	SWEDEN
Chemisches Untersuchungsamt, Trier	GERMANY
State General Laboratory, Nicosia	CYPRUS
Finnish Customs Laboratory, Espoo	FINLAND
Central Science Laboratory, York	UNITED KINGDOM
E.T.S. Laboratories, St. Helena, CA	UNITED STATES

11. REFERENCES

- [1] A. Visconti, M. Pascale, G. Centonze. *Determination of ochratoxin A in wine by means of immunoaffinity column clean-up and high-performance liquid chromatography*. Journal of Chromatography A, 864 (1999) 89-101.
- [2] AOAC International 1995, AOAC Official Methods Program, p. 23-51.

**COMPENDIUM OF INTERNATIONAL METHODS OF ANALYSIS - OIV
Ochratoxin A**

APPENDIX I

The following data was obtained in inter-laboratory tests, according to harmonised protocol recommendations for joint studies in view of validating an analysis method.

WHITE WINE		Added OTA ($\mu\text{g/l}$)			
Sample	White	0.100	1.100	2.000	n.c.
Inter-laboratory test year	1999	1999	1999	1999	1999
Number of laboratories	16	16	16	16	16
Number of laboratories retained after eliminating absurd findings	14*	13*	14	14	15
Number of eliminated laboratories	-	1	2	2	1
Number of accepted results	28	26	28	28	30
Average value ($\mu\text{g/l}$)	<0,01	0,102	1,000	1,768	0,283
Spread-type/Repeatability _r ($\mu\text{g/l}$)	-	0.01	0.07	0.15	0.03
Relative spread-type (Variation percentage) /Repeatability RSD _r (%)	-	10.0	6.6	8.5	10.6
Repeatability limit r ($\mu\text{g/l}$)	-	0.028	0.196	0.420	0.084
Spread-type/capacity of being reproduced s _R ($\mu\text{g/l}$)	-	0.01	0.14	0.23	0.04
Relative spread-type (variation percentage) /capacity of being reproduced RSD _R (%)	-	14.0	13.6	13.3	14.9
Capacity of being reproduced limit R ($\mu\text{g/l}$)	-	0.028	0.392	0.644	0.112
Extraction yield %	-	101.7	90.9	88.4	-

* 2 laboratories were excluded from the statistical 'evaluation due to high detection limit (= 0,2 $\mu\text{g/l}$).

n.c. = sample naturally contaminated

APPENDIX II

The following data was obtained in inter-laboratory tests, according to harmonised protocol recommendations for joint studies in view of validating an analysis method.

RED WINE		Added OTA ($\mu\text{g/l}$)			
		White	0.200	0.900	
Inter-laboratory test year	1999	1999	1999	1999	1999
Number of laboratories	15	15	15	15	15
Number of laboratories retained after eliminating absurd findings	14*	12*	14	15	14
Number of eliminated laboratories	-	2	1	-	1
Number of accepted results	28	24	28	30	28
Average value ($\mu\text{g/l}$)	<0.01	0.187	0.814	2.537	1.693
Spread-type/Repeatability _r ($\mu\text{g/l}$)	-	0.01	0.08	0.23	0.19
Relative spread-type (Variation percentage) /Repeatability RSD _r (%)	-	5.5	9.9	8.9	10.9
Repeatability limit r ($\mu\text{g/l}$)	-	0.028	0.224	0.644	0.532
Spread-type/capacity of being reproduced s _R ($\mu\text{g/l}$)	-	0.02	0.10	0.34	0.23
Relative spread-type (variation percentage) /capacity of being reproduced RSD _R (%)	-	9.9	12.5	13.4	13.4
Capacity of being reproduced limit R ($\mu\text{g/l}$)	-	0.056	0.280	0.952	0.644
Extraction yield %	-	93.4	90.4	84.6	-

* 1 laboratory was excluded from the statistical evaluation because of high detection limits (= 0,2 $\mu\text{g/l}$).

n.c. = naturally contaminated sample

APPENDIX III

Guide to the critical points of the method of measuring ochratoxin A by immunoaffinity column, type II.

The critical points to observe are listed below for information purposes only and are a guide to applying the method. Numbering refers to paragraphs of the resolution.

1. Field of application

For information purposes only the method can be applied to grape musts, partially fermented grape musts, and new wines still under fermentation. The validation parameters concern wines only.

2. Principle

The method is broken down into two steps. The first step involves purification and concentration of the OTA in the wine or the must by capture on an immunoaffinity column followed by elution. The second step involves quantification of the eluate by HPLC using fluorescence detection.

3. Reagents

3.4 OTA stock solution

The use of OTA in solid form is not recommended; it is recommended to use a standard solution of OTA (point 3.5)

3.5 Standard OTA solution

Use of a commercial solution of standard concentration (around 50 µg/ml) with an analysis certificate stating the reference value and uncertainty of the concentration.

In theory the volume of these solutions is not certified, and they must be sampled with certified pipettes to constitute stock solutions from 0.25 to 1 mg/l in pure ethanol or in the mobile phase of the HPLC method (see 3.2.3). This solution is stable at -18°C for at least 4 years.

4. Equipment

4.13 RECOMMENDATIONS FOR ASSESSMENT OF THE PERFORMANCE OF IMMUNOAFFINITY COLUMNS (optional)

The step of concentration on an immunoaffinity column is a major source of inaccuracy in the analysis method. Experience shows that the various columns offered on the market could have recovery rates of between 70 and 100%.

It is therefore recommended to check the performance of a batch of columns before use. This step is recommended where there has been a change in supplier or column references.

4.13.1 Characterisation of the batch of columns (measure of recovery rate):
Select around 10 columns representative of the types of column routinely used in the laboratory, and all from different batch numbers. Prepare the same number of wines representing different matrices, with zero OTA concentrations, with known additions x_i of between 0.5 and $2 \mu\text{g}\cdot\text{kg}^{-1}$. After the known additions quickly analyse these n samples with the batch of selected columns. Let y_i be the values found.
The recovery rate data are calculated, the rate being the measured quantity in relation to the known added quantity.

$$t_i = \frac{y_i}{x_i} \quad (\text{recovery rate with column } i)$$

$$T = \frac{\sum t_i}{n} \quad (\text{average recovery rate})$$

$$S_t = \sqrt{\frac{\sum (t_i - T)^2}{n - 1}} \quad (\text{standard deviation of the recovery rate})$$

The standard deviation of the recovery rate calculated in this way represents not only the variability of the recovery rate of the columns, but also the standard uncertainty of the measurement system used after use of the columns (HPLC). It is nevertheless possible to establish a reasonable estimate of the standard deviation of the recovery rate of the columns by

deducting the standard uncertainty of the HPLC system from the calculated recovery error:

- Estimate the standard uncertainty S_v (expressed as the standard deviation) of the measurement system in the strict sense of the word (without considering the the immunoaffinity column step).

For this it is possible to use a fidelity study on the OTA solutions.

The standard deviation of the recovery rate S_p is estimated as follows:

$$S_p = \sqrt{S_t^2 - S_v^2}$$

For a fairly wide concentration range, it is preferable to express this value as the coefficient of variation of the standard deviation (RSDR).

$CV\% = S_p \cdot 100 / \text{concentration of the addition}$

5. Procedure

The procedure outlined in point 5 is an example. The composition of dilution and washing solutions may differ from one column manufacturer to another. Likewise, the concentration of the diluted wine sample may be adjusted as needed.

6. Quantification of ochratoxine A (OTA)

6.1 Calibration curve

Prepare a calibration curve daily or each time that the chromatographic conditions change. Prepare the curve using solutions produced by diluting the stock solution in the mobile phase (see 3.2.3). The values chosen must provide the working range taking into account the concentration factor of the wine.

**HPLC-Determination of nine major anthocyanins
in red and rosé wine**

(Resolution Oeno 22/2003 modified by Oeno 12/2007)

1. FIELD OF APPLICATION

The analytical method concerns the determination of the relative composition of anthocyanins in red and rosé wine. The separation is performed by HPLC with reverse phase column and UV-VIS detection.

Many authors [3, 6-17] have published data on the anthocyanin composition of red wines using similar analytical methods. For instance Wulf et al. [18] have detected and identified 21 anthocyanins and Heier et al. [13] nearly 40 by liquid chromatography combined with mass spectrometry. The anthocyanin composition may be very complex, so it is necessary to have a simple procedure. Consequently this method only determines the major compounds of the whole anthocyanin fraction.

Member states are encouraged to continue research in this area to avoid any non scientific evaluation of the results.

2. PRINCIPLE

Separation of the five most important non acylated anthocyanins (see Figure 1, peaks 1-5) and four major acylated anthocyanins (see Figure 1, peaks 6-9).
Analysis of red and rosé wine by direct separation by HPLC by using reverse phase column with gradient elution by water/formic acid/acetonitrile with detection at 518 nm [1.2].

3 REAGENTS AND MATERIAL

Formic acid (p.a. 98 %) (CAS 64-18-6);

Water, HPLC grade;

Acetonitrile, HPLC grade (CAS 75-08-8);

HPLC solvents:

Solvent A: Water/Formic acid/Acetonitrile 87 : 10 : 3 (v/v/v)

Solvent B: Water/Formic acid/Acetonitrile 40 : 10 : 50 (v/v/v)

Membrane filter for HPLC solvent degassing and for sample preparation to be analysed.

Reference products for peak identification.

The HPLC analysis of anthocyanins in wine is difficult to perform due to the absence of commercially available pure products. Furthermore, anthocyanins are extremely unstable in solution.

The following anthocyanin pigments are commercially available:

Cyanidol-3-glucoside (also couromanin chloride); M = 484.84 g/mol

Peonidol-3-glucoside; M = 498.84 g/mol

Malvidol-3-glucoside (also Oeninchloride); M = 528.84 g/mol

Malvidol-3,5-diglucoside (also Malvinchloride); M = 691.04 g/mol

4. APPARATUS

HPLC system with:

binary gradient pump, injection system for sample volumes ranging from 10 to 200 μ l,

diode array detector or a UV detector with a visible range,

integrator or a computer with data acquisition software,

furnace for column heating at 40°C,

solvent degassing system,

analytical column, for example:

LiChrospher 100 RP 18 (5 μ m) in LiChroCart 250-4 guard column: for example RP 18 (30-40 mm) in a cartridge 2 mm in diameter x 20 mm long

5. PROCEDURE

5.1 Preparation of samples

Clear wines are poured directly without any preparation into the sample vials of the automatic sample changer. Cloudy samples are filtered using a 0.45 μ m membrane filter for HPLC sample preparation. The first part of the filtrate should be rejected.

Since the range of the linearity of absorption depending on the concentration of anthocyanins is large, it is possible to modulate the injection volumes between 10 and 200 μ l depending on the intensity of the wine colour. No significant difference between the results obtained for different injection volumes was observed.

5.2 Analysis

HPLC conditions

The HPLC analysis is carried out in the following conditions:

Injection Volume:	50 µl (red wine) up to 200 µl (rosé wine)
Flow:	0.8 ml/minute
Temperature:	40°C
Run time:	45 minutes
Post time:	5 minutes
Detection:	518 nm

Gradient elution:	Time (min)	Solvent A % (v/v)	Solvent B % (v/v)
	0	94	6
	15	70	30
	30	50	50
	35	40	60
	41	94	6

To check the column efficiency, the number of theoretical plates (N) calculated according to malvidol-3-glucoside should not be below 20,000, and the resolution (R) between peonidol-3-coumaryl glucoside and malvidolin-3-coumaryl glucoside should not be lower than 1.5. Below these values, the use of a new column is recommended.

A typical chromatogram is given in Figure 1, where the following anthocyanins are separated:

		Peak-N°
Group 1: “Nonacylated anthocyanidin-3-glucosides”:	delphinidol-3-glucoside	1
	cyanidol-3-glucoside	2
	petunidol-3-glucoside	3
	peonidol-3-glucoside	4
	malvidol-3-glucoside	5
Group 2: “Acetylated anthocyanidin-3-glucosides”:	peonidol-3-acetylglucoside	6
	malvidol-3-acetylglucoside	7
Group 3: “Coumarylated anthocyanidin-3-glucosides”:	peonidol-3-coumarylglucoside	8
	malvidol-3-coumarylglucoside	9

6. EXPRESSION OF RESULTS

Note that the values are expressed as relative amounts of the sum of the nine anthocyanins defined in this method.

7. LIMIT OF DETECTION AND LIMIT OF QUANTIFICATION

The limit of detection (LD) and the limit of quantification (LQ) are estimated following the instructions in the resolution OENO 7-2000 “Estimation of the Detection and Quantification Limits of a Method of Analysis“. Along the line of the ”Logic Diagram for Decision-Making” in N° 3 the graph approach has to be applied following paragraph 4.2.2.

For this purpose a part of the chromatogram is drawn out extendedly enclosing a range of a tenfold mid-height width ($w_{1/2}$) from an anthocyan relevant peak. Furthermore two parallel lines are drawn which just enclose the maximum amplitude of the signal window. The distance of these two lines gives h_{\max} , expressed in milli Absorption Units (mAU).

The limit of detection (LD) and the limit of quantification (LQ) depend on the individual measurement conditions of the chemical analysis and are to be determined by the user of the method. The Annex gives an example of its determination with the following results:

$$h_{\max} = 0,208 \text{ [mAU]}; \text{ LD} = 3 \times 0,208 \text{ [mAU]} = 0,62 \text{ [mAU]}.$$
$$\text{LQ} = 10 \times 0,208 \text{ [mAu]} = 2,08 \text{ [mAU]}.$$

Recommendation:

With combined data out of the whole Anthocyanin composition such as the sum of Acylated Anthocyanins or the ratio of Acetylated to Coumarylated Anthocyanins the calculation should not be carried out in cases where one of the components is below the limit of quantification (LQ).

On the other hand measurements below the limit of quantification (LQ) are not devoid of information content and may well be fit for purpose [1].

Bibliography:

[1] Thompson, M.; Ellison, S.L.R. ; Wood, R., Harmonized Guidelines for Single-Laboratory Validation of Methods of Analysis, Pure Appl. Chem. (2002) 74: 835-855

8. FIDELITY PARAMETERS

The repeatability (r) and the reproducibility (R) values for the nine anthocyanins are given in Table 2 and depend on the amount of the peak area. The uncertainty measurement of a particular peak area is determined by the value of r and R which corresponds to the nearest value given in Table 2.

The values made up of validation data can be calculated by following the appropriate statistical rules. To calculate the total error (sr) for example of the sum of acetylated anthocyanins, the variances (sr²) of specific the total error of ratios, for example, that of acetylated to coumarylated anthocyanins the square of relative errors (=sr/ai) are to be added. By using these rules, all the fidelity values can be calculated by using the data in Table 2.

COMPENDIUM OF INTERNATIONAL METHODS OF ANALYSIS-OIV
Anthocyanins

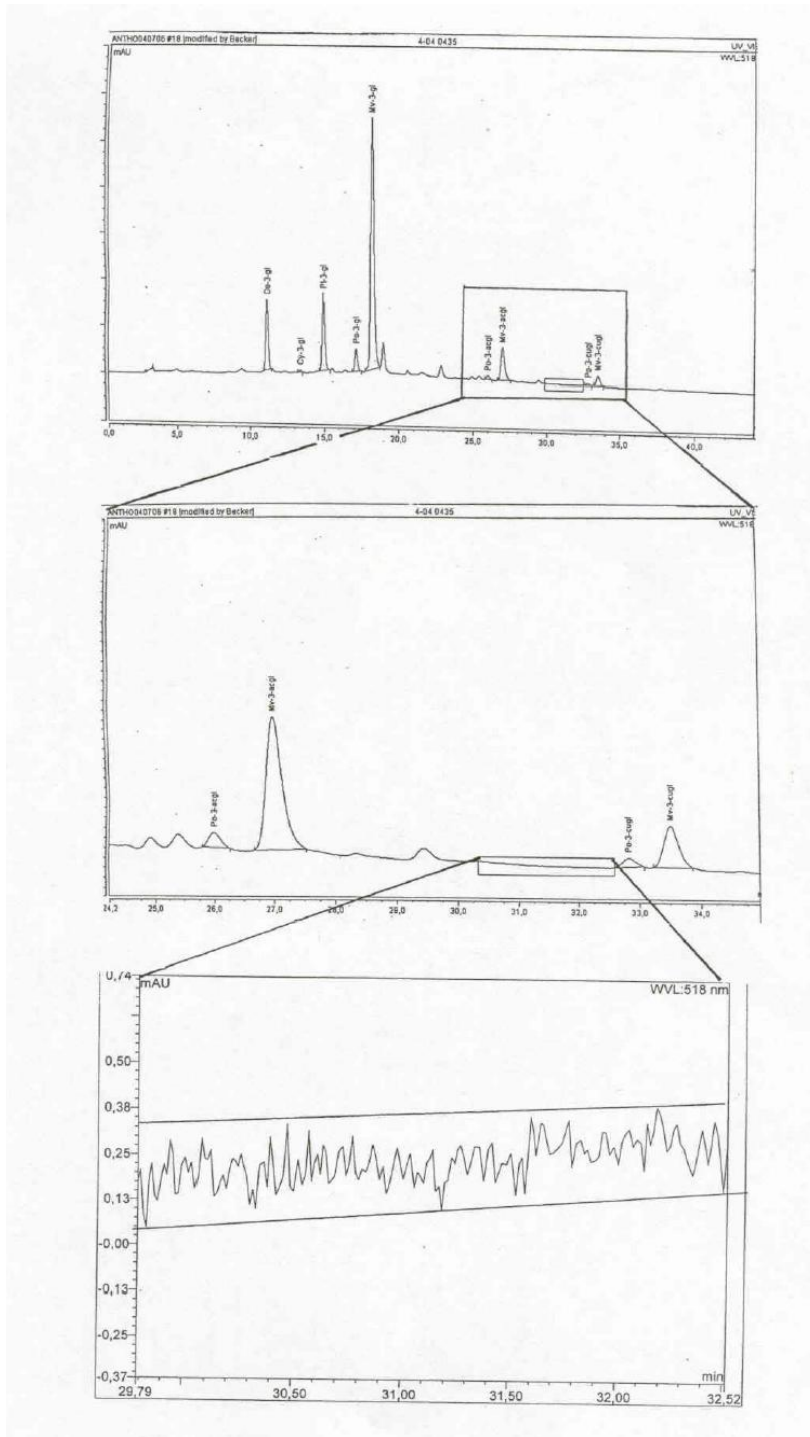

Annex A

Bibliography

- [1] Marx, R., B. Holbach, H. Otteneder; Determination of nine characteristic Anthocyanins in Wine by HPLC; OIV, F.V.N° 1104 2713/100200
- [2] Holbach, B., R. Marx, M. Ackermann; Bestimmung der Anthocyanzusammensetzung von Rotwein mittels Hochdruckflüssigkeitschromatographie (HPLC). *Lebensmittelchemie* (1997) 51: 78 - 80
- [3] Eder, R., S. Wendelin, J. Barna; Auftrennung der monomeren Rotweinthocyanine mittels Hochdruckflüssigkeitschromatographie (HPLC). Methodenvergleich und Vorstellung einer neuen Methode. *Mitt. Klosterneuburg* (1990) 40: 68-75
- [4] ISO-5725-2: 1994 "Accuracy (trueness and precision) of measurement methods and results - Part 2: Basic method for the determination of repeatability and reproducibility"
- [5] Otteneder, H., Marx, R., Olschimke, D.; Method-performance study on the determination of nine characteristic anthocyanins in wine by HPLC. O.I.V. F.V.N° 1130 (2001)
- [6] Mattivi F.; Scienza, A.; Failla, O.; Vika, P.; Anzani, R.; Redesco, G.; Gianazza, E.; Righetti, P. *Vitis vinifera - a chemotaxonomic approach: Anthocyanins in the skin. Vitis (special issue) 1990, 119-133*
- [7] Roggero, I.P.; Larice, I.L.; Rocheville-Divorne, C.; Archier, P.; Coen, V. Composition Antocyanique des cepages. *Revue Francaise d'Oenologie* 1998, 112, 41-48
- [8] Eder, R.; Wendelin, S; Barna, J. Classification of red wine cultivars by means of anthocyanin analysis. *Mitt. Klosterneuburg* 1994, 44, 201-212
- [9] Arozarena, I.; Casp, A.; Marin, R.; Navarro, M. Differentiation of some Spanish wines according to variety and region based on their anthocyanin composition. *Eur. Food Res. Technol.* 2000, 212, 108-112
- [10] Garcia-Beneytez, E.; Revilla, E.; Cabello, F. Anthocyanin pattern of

- several red grape cultivars and wines made from them. *Eur. Food Res. Technol.* **2002**, *215*, 32-37
- [11] Arozarena, I.; Ayestarán, B.; Cantalejo, M.J.; Navarro, M.; Vera, M.; Abril, K.; Casp, A. *Eur. Food Res. Technol.* **2002**, *214*, 313-309
- [12] Revilla, E.; Garcia-Beneytez, E.; Cabello, F.; Martin-Ortega, G.; Ryan, J-M. Value of high-performance liquid chromatographic analysis of anthocyanins in the differentiation of red grape cultivars and red wines made from them. *J. Chromatogr A* **2001**, *915*, 53-60
- [13] Heier, A.; Blaas, W.; Droß, A.; Wittkowski, R.; Anthocyanin Analysis by HPLC/ESI-MS, *Am.J.Enol.Vitic*, **2002**, *53*, 78-86
- [14] Arozarena, I.; Casp, A.; Marin, R.; Navarro, M. Multivariate differentiation of Spanish red wines according to region and variety. *J. Sci. Food Agric*, **2000**, *80*, 1909-1917
- [15] Anonymous. Bekanntmachung des Bundesinstituts für gesundheitlichen Verbraucherschutz und Veterinärmedizin. *Bundesgesundheitsbl. Gesundheitsforsch. Gesundheitsschutz*, **2001**, *44*, 748
- [16] Burns, I.; Mullen, W.; Landrault, N.; Teissedre, P.-L.; Lean, M.E.I.; Crozier, A. Variations in the Profile and Content of Anthocyanins in Wines made from Cabernet Sauvignon and hybrid grapes. *J. Agric. Food Chem.* **2002**, *50*, 4096-4102
- [17] Otteneder, H.; Holbach, B.; Marx, R.; Zimmer, M. Rebsortenbestimmung in Rotwein mittels Anthocyanenspektrum. *Mitt. Klosterneuburg*, **2002**, *52*, 187-194
- [18] L.W. Wulf and C.W. Nagel; High-Pressure liquid chromatographic separation of Anthocyanins of *Vitis vinifera*. *Am.J.Enol.Vitic* **1978**, *29*, 42-49

Annex B

Statistical results

Method performance study and evaluation

17 laboratories from 5 European Nations participated in the validation study of the method under the coordination of the German Official State Laboratory for Food Chemistry in Trier. The participants are listed in Table 3. An example of a chromatogram is presented in Figure 1 and the detailed results are given in Table 2.

The statistical evaluation followed the Resolution 6/99 and the Standard ISO 5725-1944 [4.5].

The chromatograms sent back with the results sheets fulfilled all requirements concerning the performance of the analytical column. No laboratory had to be completely eliminated, for example, because of a wrong peak identification.

The outlier values were searched using Dixon and Grubbs outlier testing according to the procedure for “Harmonised Protocol – IUPAC 1994” and the OIV Resolution OENO 19/2002. The values of s_r , s_R , r and R were calculated for 9 major anthocyanins at 5 content levels. For analytical results, the values of the closest levels should be used.

In order to have a global vision of the method performance, all the values RSD_r-et RSD_R- gathered are grouped by range of areas in the following table:

Table 1: Summary of the results of the method performance study

Range of relative peak areas*[%]	Range of RSD_r [%]	Range of RSD_R [%]
>0.4 – 1.0	6.8 - 22.4	20.6 - 50.9
>1.1 – 1.5	4.2 - 18.1	11.8 - 28.1
>1.5 – 3.5	2.1 – 7.7	10.6 - 15.6
>3.5 – 5.5	2.7 – 5.7	18.7 – 7.5
>5.5 – 7.5	2.4 – 3.9	6.5 - 10.0
>10 – 14	1.1 – 2.9	3.7 - 9.2
>14 – 17	1.0 - 3.9	3.2 - 5.4
>50 – 76	0.3 - 1.0	2.1 - 3.1
* independent of anthocyanin		

This leads to the conclusion that repeatabilities and reproducibilities depend on the total sum of the relative peak areas. The higher they are, the better are RSDr and RSDR. For anthocyanin contents close to the detection limit (e.g. Cyanidin-3-glucoside) with small relative areas (less than 1%) the RSDr et RSDR values can rise significantly. For anthocyanin whose relative areas are more than 1%, the RSDr and RSDR values are reasonable.

Figure 1: Separation of 9 anthocyanins in red wine

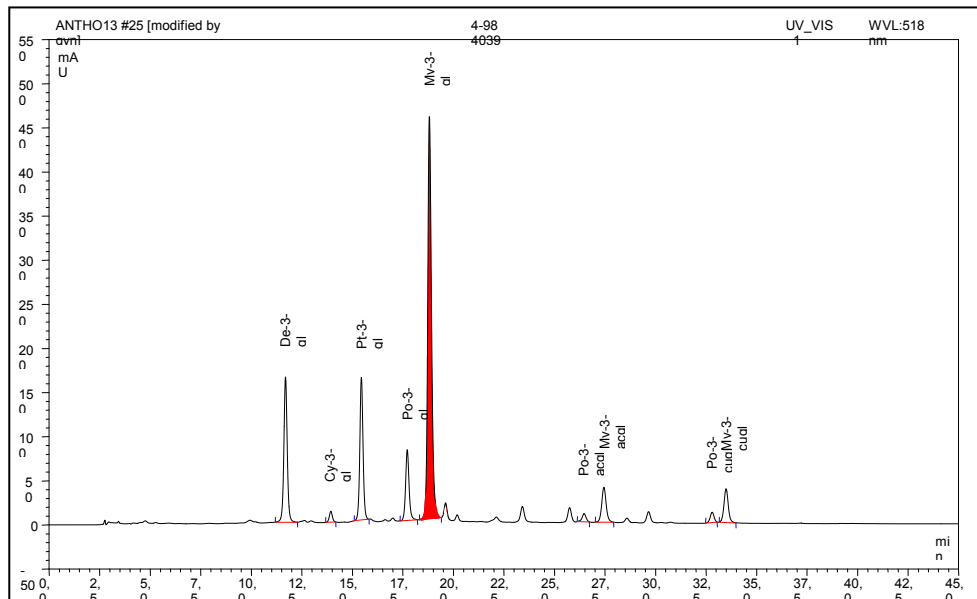

**COMPENDIUM OF INTERNATIONAL METHODS OF ANALYSIS-OIV
Anthocyanins**

Table 2: Results of the method performance study

Anthocyanin	sample 1	sample 2	sample 3	sample 4	sample 5
<i>Delphinidol-3-glucoside</i>					
n	14	14	16	15	16
mean	6.75	14.14	3.45	16.68	3.54
s _r	0.163	0.145	0.142	0.142	0.108
RSD _r (%)	2.4	1.0	4.1	0.8	3.1
r	0.46	0.41	0.40	0.40	0.30
s _R	0.544	0.462	0.526	0.704	0.490
RSD _R (%)	8.1	3.3	15.2	4.2	13.8
R	1.52	1.29	1.47	1.97	1.37
<i>Cyanidol-3-glucoside</i>					
n	16	17	16	15	14
mean	2.18	1.23	0.61	1.46	0.34
s _r	0.086	0.053	0.043	0.110	0.031
RSD _r (%)	4.0	4.3	7.1	7.5	9.2
r	0.24	0.15	0.12	0.31	0.09
s _R	0.460	0.211	0.213	0.180	0.158
RSD _R (%)	21.2	17.2	34.9	12.3	46.7
R	1.29	0.59	0.60	0.50	0.44
<i>Petunidol-3-glucoside</i>					
n	15	17	16	14	15
mean	10.24	14.29	5.75	12.21	6.19
s _r	0.233	0.596	0.157	0.097	0.196
RSD _r (%)	2.3	4.2	2.7	0.8	3.2
r	0.65	1.67	0.44	0.27	0.55
s _R	0.431	0.996	0.495	0.469	0.404
RSD _R (%)	4.2	7.0	8.6	3.8	6.5
R	1.21	2.79	1.39	1.31	1.13
<i>Peonidol-3-glucoside</i>					
n	16	15	17	17	16
mean	11.88	6.23	13.75	7.44	4.12
s _r	0.241	0.166	0.144	0.232	0.174
RSD _r (%)	2.0	2.7	1.0	3.1	4.2
r	0.68	0.47	0.40	0.65	0.49
s _R	0.981	0.560	1.227	0.602	0.532
RSD _R (%)	8.3	9.0	8.9	8.1	12.9
R	2.75	1.57	3.44	1.69	1.49
<i>Malvidol-3-glucoside</i>					
n	16	15	17	16	16
mean	55.90	55.04	76.11	52.60	61.04
s _r	0.545	0.272	0.251	0.298	0.377
RSD _r (%)	1.0	0.5	0.3	0.6	0.6
r	1.53	0.76	0.70	0.83	1.06
s _R	2.026	2.649	2.291	1.606	1.986
RSD _R (%)	3.6	4.8	3.0	3.1	3.3
R	5.67	7.42	6.41	4.50	5.56
n	= N° of laboratories retained after eliminating outliers				
s _r	= standard deviation of repeatability				
RSD _r (%)	= relative standard deviation of repeatability				
r	= repeatability				
s _R	= standard deviation of reproducibility				
RSD _R (%)	= relative standard deviation of reproducibility				
R	= reproducibility				

**COMPENDIUM OF INTERNATIONAL METHODS OF ANALYSIS-OIV
Anthocyanins**

Table 2: Results of the method performance study

Anthocyanin	sample 1	sample 2	sample 3	sample 4	sample 5
<i>Peonidol-3-acetylglucoside</i>					
n	14	16		14	16
mean	1.16	1.44		0.59	3.74
s _r	0.064	0.062		0.059	0.215
RSD _r (%)	5.5	4.3		10.1	5.8
	0.18	0.17		0.17	0.60
s _R	0.511	0.392		0.272	0.374
RSD _R (%)	43.9	27.2		46.4	10.0
R	1.43	1.10		0.76	1.05
<i>Malvidol-3-acetylglucoside</i>					
n	16	17		17	16
mean	5.51	4.84		3.11	15.07
s _r	0.176	0.167		0.088	0.213
RSD _r (%)	3.2	3.4		2.8	1.4
r	0.49	0.47		0.25	0.60
s _R	0.395	0.366		0.496	0.617
RSD _R (%)	7.2	7.6		16.0	4.1
R	1.11	1.02		1.39	1.73
<i>Peonidol-3-coumarylglucoside</i>					
n	16	14		17	16
mean	1.26	0.90		0.89	1.32
s _r	0.130	0.046		0.060	0.058
RSD _r (%)	10.3	5.1		6.8	4.4
r	0.36	0.13		0.17	0.16
s _R	0.309	0.109		0.204	0.156
RSD _R (%)	24.5	12.2		23.0	11.8
R	0.86	0.31		0.57	0.44
<i>Malvidol-3-coumarylglucoside</i>					
n	17	17		17	16
mean	4.62	2.66		4.54	4.45
s _r	0.159	0.055		0.124	0.048
RSD _r (%)	3.4	2.1		2.7	1.1
r	0.45	0.15		0.35	0.13
s _R	0.865	0.392		0.574	0.364
RSD _R (%)	18.7	14.7		12.6	8.2
R	2.42	1.10		1.61	1.02
n	= N° of laboratories retained after eliminating outliers				
s _r	= standard deviation of repeatability				
RSD _r (%)	= relative standard deviation of repeatability				
r	= repeatability				
s _R	= standard deviation of reproducibility				
RSD _R (%)	= relative standard deviation of reproducibility				
R	= reproducibility				

Table 3: List of participants

ABC Labor Dahmen, Mülheim/Mosel	<u>D</u>
Chemisches Landes- und Staatliches Veterinäruntersuchungsamt Münster	D
Institut für Lebensmittelchemie Koblenz	D
Institut für Lebensmittelchemie Speyer	D
Institut für Lebensmittelchemie Trier	D
Institut für Lebensmittelchemie und Arzneimittel Mainz	D
Labor Dr. Haase-Aschoff, Bad Kreuznach	D
Labor Dr. Klaus Millies, Hofheim-Wildsachsen	D
Labor Heidger, Kesten	D
Landesveterinär- und Lebensmitteluntersuchungsamt Halle	D
Staatliche Lehr- und Forschungsanstalt für Landwirtschaft, Weinbau und Gartenbau, Neustadt/Weinstraße	D
Staatliches Institut für Gesundheit und Umwelt, Saarbrücken	D
Staatliches Medizinal-, Lebensmittel- und Veterinäruntersuchungsamt, Wiesbaden	D
Laboratoire Interrégional de la D.G.C.C.R.F de Bordeaux, Talence/France	<u>F</u>
Unidad de Nutricion y Bromotologia, Facultad de Farmacia, Universidad de Salamanca, Salamanca/Espana	<u>E</u>
University of Glasgow, Div. of Biochem. and Molek. Biology	<u>UK</u>
Höhere Bundeslehranstalt und Bundesamt für Wein- und Obstbau, Klosterneuburg	<u>A</u>

17 Laboratories D (13); A (1); F (1); E (1); UK (1)

Method OIV-MA-AS315-12

Type IV method

Determination of plant proteins in wines and musts
(Resolution Oeno 24/2004)

The technique developed below enables to determine the quantity of proteins possibly remaining in beverages treated with proteins of plant origin after racking.

1 PRINCIPLE

Wine and must proteins are precipitated with trichloroacetic acid, then they are separated by electrophoresis in polyacrylamide gel in the presence of dodecyl sodium sulphate (DSS). The addition of Coomassie blue colours the proteins. The intensity of the colouration enables to determine the protein content using a calibration curve made beforehand with the known protein concentration solutions. The antigenic capacity of musts and treated wines is determined by immunoblotting testing.

2 PROTOCOL

2.1 Concentration of proteins by precipitation with trichloroacetic acid (TCA)

2.1.1 Reagents

2.1.1.1 Pure trichloroacetic acid (TCA)

2.1.1.2 TCA at 0.1% prepared using 2.1.1.1: 0.1 g in 100 ml of water.

2.1.1.3 TCA at 100% prepared using 2.1.1.1: 100 g in 100 ml of water.

2.1.1.4 Sodium hydroxide 0.5 M

2.1.1.5 Buffer Tris/HCl 0.25 M pH=6.8

30.27 g of Tris-(hydroxymethyl)aminomethane (Tris) are dissolved in 300 ml of distilled water. The pH is adjusted to 6.8 with concentrated

hydrochloric acid for analysis. The volume is completed to 1 l with distilled water. The buffer is stored at 4°C.

2.1.1.6 Pure glycerol

2.1.1.7 Pure dodecyl sodium sulphate (DSS)

2.1.1.8 Pure 2-mercaptoethanol

2.1.1.9 Buffer solution for samples: it is made up of a buffer Tris/HCl 0.25 M, pH=6.8 (2.1.1.5); 7.5% of pure glycerol (2.1.1.6); 2% of dodecyl sodium sulphate (DSS) (2.1.1.7) and 5% of pure 2-mercaptoethanol (2.1.1.8). The percentages of different reagents correspond to the final concentration in the buffer solution.

2.1.2 Procedure

3 ml of trichloroacetic acid at 100% (2.1.1.3) and 24 ml of wine or must (treated or untreated) are successively put in 50 ml centrifuge tubes. The final concentration in TCA thus obtained is 11%.

After 30 minutes at 4°C, the samples are centrifuged at 10,000 rpm for 30 minutes at 4°C. The pellets are washed in an aqueous solution of TCA at 0.1% (2.1.1.2), re-centrifuged and put again in suspension in 0.24 ml mixture (1:1, v/v) of sodium hydroxide 0.5 M (2.1.1.4) and buffer solution (2.1.1.9). The samples are heated at 100°C in a water bath for 10 minutes.

2.2 Electrophoresis in Polyacrylamide Gel in the presence of DSS

2.2.1 Reagents

2.2.1.1 Buffer Tris/HCl 1.5 M pH=8.8

181.6 g of Tris-(hydroxymethyl)aminomethane are dissolved in 300 ml of distilled water. The pH is adjusted at 8.8 with concentrated hydrochloric acid for analysis. The volume is completed to 1 l with distilled water. The buffer is stored at 4°C.

2.2.1.2 Mixture of acrylamide (30%)–bis-acrylamide (0.8%)–glycerol (75%)

Slowly add 300 g of acrylamide and 8 g of bis-acrylamide to 600 ml of a glycerol solution at 75%. After dissolution, adjust the volume to 1 l with glycerol at 75%. The mixture is stored in the dark at room temperature.

2.2.1.3 DSS at 10%

10 g of DSS are dissolved in 100 ml of distilled water. Store at room temperature.

2.2.1.4 N,N,N',N'-tetramethylethylenediamine (TEMED) for electrophoresis

2.2.1.5 Ammonium persulfate at 10%

1 g of ammonium persulfate is dissolved in 10 ml of distilled water. Store at 4°C.

2.2.1.6 Bromophenol blue solution

10 mg of bromophenol blue for electrophoresis are dissolved in 10 ml of distilled water.

2.2.1.7 Solution for the separation gel (15% of acrylamide)

It is prepared just before use:

- 1.5 ml of Tris/HCl 1.5 M, pH=8.8 (2.2.1.1),
- 1.5 ml of distilled water,
- 3 ml of glycerol acrylamide mixture (2.2.1.2),
- 50 µl of DSS 10% (2.2.1.3),
- 10 µl of N,N,N',N'-tetramethylethylenediamine (TEMED) for electrophoresis (2.2.1.4),
- 20 µl of ammonium persulfate (2.2.1.5).
- 1 drop of bromophenol blue (2.2.1.6)

2.2.1.8 Buffer Tris/HCl 0.5 M pH=6.8

60.4 g of Tris-(hydroxymethyl)aminomethane are dissolved in 400 ml of distilled water. The pH is adjusted to 6.8 with concentrated hydrochloric acid for analysis. The volume is completed to 1 l with distilled water. The buffer is stored at 4°C.

2.2.1.9 Mixture of acrylamide (30%)–bis-acrylamide (0.8%)–water

Slowly add 300 g of acrylamide and 8 g of bis-acrylamide to 300 ml of water. After dissolution, adjust the volume to 1 l with distilled water. The mixture is stored in the dark at room temperature.

2.2.1.10 Concentration gel at 3.5% of acrylamide

It is prepared just before use:

- 0.5 ml of Tris/HCl 0.5 M pH=6.8 (2.2.1.8),
- 1.27 ml of distilled water,
- 0.23 ml of water acrylamide mixture (2.2.1.9),
- 20 µl of DSS 10% (2.2.1.3),
- 5 µl of N,N,N',N'-tetramethylethylenediamine (TEMED) for electrophoresis (2.2.1.4),
- 25 µl of ammonium persulfate (2.2.1.5),
- 1 drop of bromophenol blue (2.2.1.6).

2.2.1.11 Migration buffer

30.27 g of Tris-(hydroxymethyl)aminomethane, 144 g of glycine and 10 g of DSS are dissolved in 600 ml of distilled water. The pH should be 8.8. If necessary, it is adjusted with concentrated hydrochloric acid for analysis. The volume is completed to 1 l with distilled water. The buffer is stored at 4°C. At the time of use, the solution is diluted to 1/10 in distilled water.

2.2.1.12 Colouring solution

Are successively mixed:

- 16 ml of ultra-pure Coomassie brilliant blue G-250 at 5% (5 g in 100 ml of distilled water),
- 784 ml from a 1 l solution where 100 g of ammonium sulphate and 13.8 ml of orthophosphoric acid at 85% were dissolved for analysis,
- 200 ml of absolute ethanol.

2.2.1.13 Discolouring solution

Are successively mixed:

- 100 ml of glacial acetic acid 100% for analysis,
- 200 ml of absolute ethanol for analysis.
- 700 ml of distilled water.

2.2.2 Procedure

The separation gel solution (2.2.1.7) is poured between two glass plates of 7x10cm. The upper surface of the gel is levelled by the addition of 2 drops of distilled water.

After polymerisation of the separation gel and the elimination of water, 1 ml of concentration gel (2.2.1.10) is deposited on the separation gel using a 1 ml pipette. Then the comb is set up whose imprints will create deposit wells.

The samples necessary for the calibration range are prepared in a mixture (1:1), v/v, 0.5% M sodium hydroxide (2.1.1.4) and the buffer solution (2.1.1.9) in order for the calibration range be between 5 µg/ml and 50 µg/ml.

20 to 30 µl of wine and calibration solution are deposited in the wells.

After migration (at a constant voltage of 90 V) at room temperature for about 3-4 hours, the gels are removed from the mould. They are immediately plunged into 50 ml of an aqueous solution of TCA 20% for 30 minutes then in 50 ml of the colouring solution (2.2.1.12).

The proteins appear in the form of blue coloured bands. The gel is then discoloured with 50 ml of discolouring solution (2.2.1.13). When the bottom of the gel is transparent, it is placed in distilled water for storage.

3. QUANTITATIVE ANALYSIS

The intensity of each spot is evaluated by using a scanner for gel with an image analyser software. The quantity of protein on the gel is determined by the calculation of the average density of the pixels of the band and by integration of the band width. The protein content of each sample is obtained using a calibration curve. The points of this curve are obtained by tracing the known concentration values of plant proteins deposited on the gel depending on the corresponding integration area.

The detection and quantification limit is about 0.030 ppm for peas and at 0.36 ppm for gluten, in an environment concentrated 100 times. The coefficient of variation is always below 5%.

4 SEARCH BY IMMUNOBLOTTING OF THE ANTIGENIC POTENTIAL OF WINES AND MUSTS TREATED

The antigenic capacity of proteins that could remain in the beverages treated after racking is then evaluated.

4.1 PRINCIPLE

After electrophoresis, the gels are submitted to the immunoblotting technique. The proteins are transferred to a membrane where they are adsorbed. An antigen-antibody complex is formed by the addition of a plant anti-protein antibody (for example anti-gliadin antibodies if the plant protein is gluten). The method is revealed by the addition of an antibody directed against the plant anti-protein antibodies coupled with phosphatase. In the presence of the chromogenic substrate of the enzyme, a colouration whose intensity will be proportional to the quantity of immunocomplexes will develop. This immunoreactivity will be quantified using a calibration curve made with known concentration plant proteins solutions.

4.2 PROTOCOL

4.2.1 : Reagents

4.2.1.1 Transfer buffer

3.03 g of Tris, 14.4 g of glycine (R), 200 ml of methanol (R) are mixed and completed to 1 l with distilled water.

4.2.1.2 Gelatine 1%

8.77 g of sodium chloride (R), 18.6 g of ethylenediaminetetraacetic acid (EDTA) for analysis, 6.06 g of Tris and 0.5 ml of Triton X are dissolved in 800 ml of distilled water. The pH is adjusted to 7.5 with concentrated hydrochloric acid for analysis. 10 g of gelatine are added and the volume is completed to 1 l.

4.2.1.3 Gelatine 0.25%

8.77 g of sodium chloride (R), 18.6 g of ethylenediaminetetraacetic acid (EDTA) for analysis, 6.06 g of Tris and 0.5 ml of Triton X are dissolved in 800 ml

of distilled water. The pH is adjusted to 7.5 with concentrated hydrochloric acid for analysis. 2.5 g of gelatine are added and the volume is completed to 1 l.

4.2.1.4 Polyclonal antibody solution (marketed or described in the annex)

- 10 µl of polyclonal plant anti-protein antibodies
- q.s.f. 10 ml with gelatine at 0.25% (4.2.1.3).

4.2.1.5 TBS buffer

29.22 g of sodium chloride for analysis and 2.42 g of tris are dissolved in 1 l of distilled water.

4.2.1.6 Alkaline phosphatase buffer

5.84 g of sodium chloride (R), 1.02 g of magnesium chloride (R) and 12.11 g of Tris are dissolved in 800 ml of distilled water. The pH is adjusted to 9.5 with concentrated hydrochloric acid and the volume is completed to 1 l.

4.2.1.7 Developer

15 g of bromochloroindol phosphate (BICP) and 30 g of nitro blue tetrazolium (NBT) are dissolved in 100 ml of alkaline phosphatase buffer (4.2.1.6).

4.2.2 Procedure

After electrophoresis, the proteins are transferred from the gel to a membrane of polyvinylidene difluoride by electrophoretic elution: 16 hours at 4°C at 30 V in the transfer buffer (4.2.1.1). The membranes are saturated with gelatine at 1% (4.2.1.2) and washed 3 times with gelatine at 0.25% (4.2.1.3). The gelatine becomes set on free sites and inhibits non specific adsorption of immunological reagents. The membrane is then plunged into 10 ml of the plant anti-protein polyclonal antibody solution (4.2.1.4). For gluten, the anti-gliadin antibodies are purchased. The other antibody types are prepared according to the method provided for in the annex. The IgG-antigen complex is detected by the addition of 10 µl of anti-IgG rabbit antibodies marked with alkaline phosphatase. The membranes are washed twice with gelatine 0.25% (4.2.1.3) and once with the TBS buffer (4.2.1.5). After incubation in the developer (4.2.1.7), a dark purple precipitate is formed in the spot where the enzyme is attached.

4.3 QUANTITATIVE ANALYSIS

In order to calculate the quantity of residual immunoreactivity of a marketed wine, a calibration curve is traced out: known concentrations of plant proteins deposited on the gel (and transferred to a membrane) depending on the areas obtained by integration of the intensity of the spots corresponding to the formation of immune-complex. The analysis is done with the same equipment as for analysing electrophoresis gels.

ANNEX

Production of polyclonal anti-peas

Anti-peas polyclonal antibodies necessary for the determination of antigenic capacity of pea proteins in wine and musts treated are being carried out on animals.

1 Principle

Serums containing polyclonal antibodies are obtained from New Zealand rabbits after an intradermal injection of antigen.

2 Protocol

2.1 Reagents

2.1.1 PBS pH=7.4 phosphate buffer: 8 g of NaCl, 200 mg of KCl, 1.73 of Na₂HPO₄ H₂O and 200 mg of KH₂PO₄ are dissolved in 300 ml of distilled water. pH is adjusted to 7.4 with sodium hydrate 1 M. The volume is brought to 1 l with distilled water.

2.1.2 Antigens:

10 mg of pea protein is dissolved in 5 ml of PBS phosphate buffer (2.1.1). The solution is then filtered under sterile conditions through 0.2 µm and stored at -20°C until the day of immunization.

2.2 Procedure

1 ml of 2.1.2. solution is mixed with 1 ml of Freund complete adjuvant. 1 ml of this mixture is injected intradermally to a New Zealand rabbit weighing approximately 3 kg. This injection is repeated on day 15, day 30 and day 45.

60 days after the first injection, 100µl of blood were withdrawn from the auricular vein which was then tested for its capacity to react to antigens. Immunoblotting was used for this evaluation as described in Chapter 4.2 of the analysis method using a gel with a pea protein which migrated on the gel.

After checking the formation of an antigen-antibody complex, 15 ml of blood were withdrawn from the auricular vein. The blood is placed at 37°C for 30 minutes. The serum containing the anti-pea polyclonal antibodies is withdrawn after centrifuging the blood at 3000 rpm for 5 minutes.

Method OIV-MA-AS315-13

Type IV method

**Determining the presence and content of polychlorophenols
and polychloroanisols in wines, cork stoppers, wood and
bentonites used as atmospheric traps**
(Resolution 8/2006)

WITHDRAWN
(Replaced by OIV-MA-AS315-16)

Method OIV-MA-AS315-14

Type IV method

**Measurement of lysozyme in wine
by high performance liquid chromatography**
(Resolution Oeno 8/2007)

1. Introduction

It is preferable to have an analysis method available for lysozyme which is not based on enzyme activity.

2. Scope

The method allows the quantification of lysozyme (mg of protein per l) present in red and white wines independently of the enzyme activity (which could be inhibited by partial denaturation or by complex formation or coprecipitation phenomena) found in the test solution.

3. Definition

HPLC provides an analytical approach based on steric, polar or adsorptive interactions between the stationary phase and the analyte, and is therefore not linked to the actual enzyme activity exhibited by the protein.

4. Principle

The analysis is carried out using HPLC with a spectrophotometric detector combined with a spectrofluorimetric detector. The unknown quantity in the wine sample is calculated on the chromatographic peak areas, using the external calibration method.

5. Reagents

5.1. Solvents and working solutions

HPLC analysis on Acetonitrile (CH₃CN)

Pure trifluoroacetic acid (TFA)

deionised water for HPLC analysis

Standard solution: Tartaric acid 1g/L, Ethyl alcohol 10% v/v, adjusted to pH 3.2 with neutral potassium tartrate.

5.2. Eluents

- A: CH₃CN 1%, TFA 0.2 %, H₂O= 98.8%
B: CH₃CN 70%, TFA 0.2 %, H₂O= 29.8%

5.3. Reference solutions

Quantities from 1 to 250 mg/L standard lysozyme, dissolved in standard solution by stirring continuously for at least 12 hours.

6. Equipment

- 6.1. HPLC apparatus equipped with a pumping system suitable for gradient elution
- 6.2. Thermostated column compartment (oven)
- 6.3. Spectrophotometer combined with spectrofluorimeter
- 6.4. 20 µL loop injection
- 6.5. Column: polymer in reverse phase with phenyl functional groups (diameter of pores = 1000 Å, exclusion limit = 1000000 Da) Toso Bioscience TSK-gel Phenyl 5PW RP, 7.5 cm x 4.6 mm ID as an example
- 6.6. Pre-column in the same material as the column: Toso Bioscience TSK-gel Phenyl 5PW RP Guardgel, 1.5 cm 3.2mm ID as an example

7. Preparation of the sample

The wine samples are acidified with HCl (10M) diluted 1/10 and filtered using a polyamide with 0.22 µm diameter pores filter, 5 minutes after the addition. The chromatography analysis is carried out immediately after filtering.

8. Operating conditions

- 8.1. Eluent flow-rate: 1mL/min
- 8.2. Temperature of column: 30°C
- 8.3. Spectrophotometric detection: 280 nm
- 8.4. Spectrofluorimetric detection:
 λ ex = 276 nm;
 λ em = 345 nm;
 Gain = 10
- 8.5. Gradient elution sequence

Time (min)	A%	B%	gradient
0	100	0	
			isocratic
3	100	0	
			linear
10	65	35	
			isocratic
15	65	35	
			linear
27	40.5	59.5	
			linear
29	0	100	
			isocratic
34	0	100	
			linear
36	100	0	
			isocratic
40	100	0	

8.6 Average retention time of lysozyme: 25.50 minutes

9. Calculation

The reference solutions containing the following concentrations of lysozyme: 1; 5; 10; 50; 100; 200; 250 mg/L are analysed in triplicate. For each chromatogram, the peak areas corresponding to the lysozyme are plotted according to the respective concentrations, in order to obtain the linear regression lines expressed by the formula $Y = ax + b$. The correlation coefficient r^2 must be > 0.999

10. Characteristics of the method

A validation study was carried out for the purpose of assessing the suitability of the method for the purpose in question, taking into account linearity, limits of detection and quantification and the accuracy of the method. The latter parameter was determined by defining the levels of precision and trueness of the method.

COMPENDIUM OF INTERNATIONAL ANALYSIS OF METHODS - OIV
Lysozyme

10.1 Linearity of the method

Based on the results obtained from the linear regression analysis, the method proved to be linear within the ranges shown in the table below:

	Linearity range (mg/L)	Line gradient	Correlation coefficient (r^2)	LD (mg/L)	LQ (mg/L)	Repeatability (n=5) RSD%			Reproducibility (n=5) RSD%
						Std ¹	V.R. ²	V.B. ³	Std ¹
UV	5-250	3 786	0,9993	1,86	6,20	4,67	5,54	0,62	1,93
FLD	1-250	52 037	0,9990	0,18	0,59	2,61	2,37	0,68	2,30

Table 1: Data related to characteristics of the method: ¹ standard solution ; ² red wine ; ³ white wine

10.2 Limit of detection and limit of quantification

The detection limit (LD) and limit of quantification (LQ) were calculated as the signal equivalent to respectively 3 times and 10 times the background chromatography noise under working conditions on an actual test solution (table 1),

10.3 Precision of the method

The parameters taken into account were repeatability and reproducibility. Table 1 shows the values of these parameters (expressed as %age St.dv. of measurements repeated in different concentrations) found for standard solution, red wine and white wine

10.4 Trueness of the method

The percentage recovery was calculated on the standard solutions containing 5 and 50 mg/L of lysozyme, with known quantities of lysozyme added, as shown in the table below.

COMPENDIUM OF INTERNATIONAL ANALYSIS OF METHODS - OIV
Lysozyme

	Nominal initial [C] (mg/L)	Quantity added (mg/L)	Theoretical [C] (mg/L)	[C] found	Std.Dev.	%age recovery
UV 280 nm	50	13.1	63.1	62.3	3.86	99
FD	50	13.1	63.1	64.5	5.36	102
UV 280 nm	5	14.4	19.4	17.9	1.49	92.1
FD	5	14.4	19.4	19.0	1.61	97.7

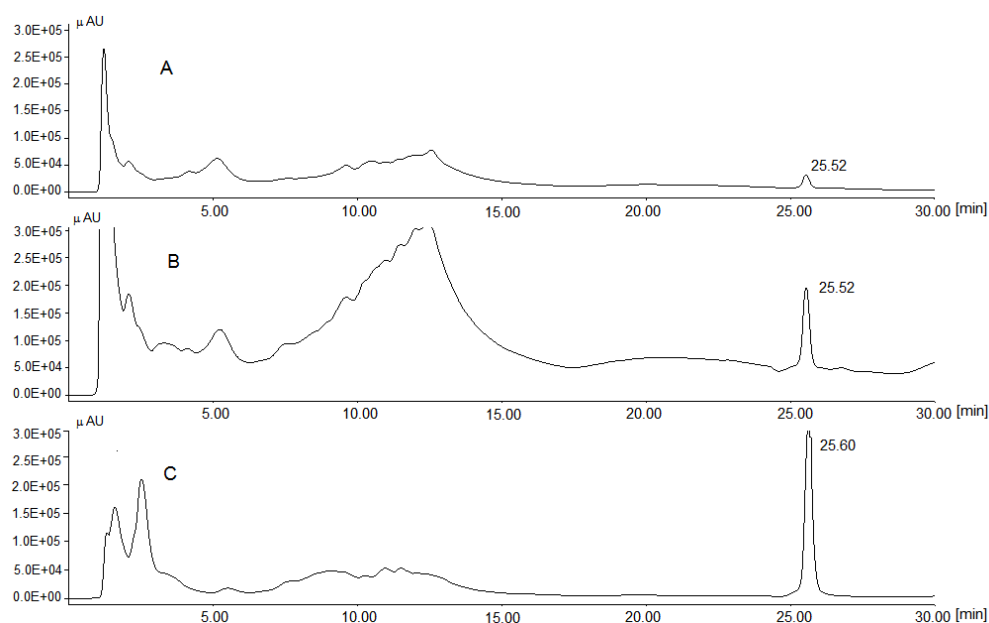

Fig.1 Chromatogram of red wine containing pure lysozyme (standard solution containing 1 000 mg/L of lysozyme was added to wine to obtain a final concentration of 125 mg/L of lysozyme). A: UV detector at 280 nm; B: UV detector at 225 nm; C: FLD detector (λ_{ex} 276 nm; λ_{em} 345 nm).

11. Bibliography

Claudio Riponi; Nadia Natali; Fabio Chinnici. Quantitation of hen's egg white lysozyme in wines by an improved HPLC-FLD analytical method. *Am. J. Enol. Vit.*, in press.

Determination of 3-methoxypropane-1,2-diol and cyclic diglycerols (by-products of technical glycerol) in wine by GC-MS
- description of the method and collaborative study -
(Resolution Oeno 11/2007)

1. Introduction

This is an internationally validated method for the determination of 3-methoxypropane-1,2-diol (3-MPD) and cyclic diglycerols (CycDs) - both being recognised as impurities of technical glycerol - in different types of wine. It is known that glycerol produced by transesterification of plant and animal triglycerides using methanol contains considerable amounts of 3-MPD. The synthesis of glycerol from petrochemicals leads to impurities of CycDs. One of the published methods [1, 2, 3i] was adopted, modified and tested in an collaborative study. Here we present the optimized method and report the results of the collaborative study [2]. Design and assessment of the validation study followed the O.I.V. Resolution 8/2000 "Validation Protocol of Analytical Methods".

2. Scope

The described method is suitable for the determination of 3-MPD and 6 cyclic diglycerols (cis-, trans-2,6-bis(hydroxymethyl) 1,4-dioxane; cis-, trans-2,5-bis(hydroxymethyl) 1,4-dioxane; cis-, trans-2,-hydroxymethyl-6-hydroxy-1,4-dioxepane) in white, red, sweet and dry wines. The study described covers the concentration range of 0.1 to 0.8 mg/L for 3-MPD and 0.5 to 1.5 mg/L for the CycDs.

3. Definitions

3-MPD	3-methoxypropane-1,2-diol
ANOVA	Analysis of Variance
C	Concentration
CycDs	Cyclic diglycerols
GC-MS	Gas chromatography – mass spectrometry
H ₂	Hydrogen
IS	Internal standard
m/z	mass/charge ratio
ML	Matrix calibration level
S0	Standard dilution 1000 ng/μL

S1	Standard dilution 100 ng/μL
S2	Standard dilution 10 ng/μL

4. Principle

The analytes and the internal standard are salted-out by addition of K₂CO₃, and extracted using diethyl ether. Extracts are analyzed directly by GC-MS on a polar column. Detection is then carried out in selected ion monitoring mode.

5. Reagents and Materials

5.1. Chemicals

- 5.1.1 K₂CO₃ p.A .
- 5.1.2 Diethyl ether Uvasol for spectroscopy
- 5.1.3 Molecular sieve (2 mm diameter, pore size 0.5 nm)
- 5.1.4 Ethanol (Absolute)

5.2. Standards

- 5.2.1 Cyclic diglycerol mixture (6 components) Solvay Alkali GmbH¹, 89.3 %
cis-, trans-2,6-bis(hydroxymethyl) 1,4-dioxane; cis-, trans-2,5-bis(hydroxymethyl) 1,4-dioxane; cis-, trans-2,-hydroxymethyl-6-hydroxy-1,4-dioxepane
- 5.2.2 3-Methoxypropane-1,2-diol (3-MPD) 98% (CAS 623-39-2)
- 5.2.3 Butane-1,4 -diol-1,1,2,2,3,3,4,4-(²H)₈ 98% (CAS 74829-49-5)

5.3. Preparation of standard solutions

5.3.1 S0 stock solutions

Accurately weigh 10.0 mg ± 0.05 mg of each standard substance (11.2 mg are weighed for the CycDs, corresponding to 89.3 % purity) and transfer them to a 10 mL volumetric flask (one for each). Add exactly 10 mL of ethanol and mix thoroughly. The concentration of this solution is 1000 ng/μL.

5.3.2 S1 working solutions

Volumetrically transfer 1000 μL of the S0 stock solution (6.3.1) to a 10 mL volumetric flask, dilute the contents to volume with ethanol, thoroughly stopper the flask and invert to mix. The concentration of this solution is 100 ng/μL.

¹ Solvay Alkali GmbH no longer provides the standard mixture; solutions of the mixture may be obtained from the BfR. Federal Institute for Risk Assessment, Thielallee 88-92, D-14195 Berlin. www.bfr.bund.de; poststelle@bfr.bund.de

5.3.3 S2 working solutions

Volumetrically transfer 100 µL of the S0 stock solution (6.3.1) to a 10 mL volumetric flask, dilute the content to volume with ethanol, thoroughly stopper the flask and invert to mix. The concentration of this solution is 10 ng/µL.

Overview of required standard solutions:
CycDs mixture (6 components)

Solution	Concentration	
S0	1000	ng/µL
S1	100	ng/µL

3-Methoxypropane-1,2-diol (3-MPD)

Solution	Concentration	
S0	1000	ng/µL
S1	100	ng/µL
S2	10	ng/µL

1,4 Butane-1,4-(²H)₈ (internal standard IS)

Solution	Concentration	
S0	1000	ng/µL
S1	100	ng/µL

5.4. Preparation of the matrix calibration curve

Matrix-matched calibration solutions are prepared in an uncontaminated wine. It is necessary to analyze this wine first to check that it is not contaminated with 3-MPD or CycDs. If the concentrations of the analytes in the sample are outside the range of the calibration curve, additional levels must be prepared. To ensure that the internal standard does not interfere with any wine components, a blank should be included.

**COMPENDIUM OF INTERNATIONAL ANALYSIS OF METHODS - OIV
3-Methoxypropane-1,2-diol and Cyclic Diglycerols**

Table 1. Pipetting scheme of matrix calibration

Matrix calibration level		Spike μ l	Volume C Wine C Wine			
			ml	μ g/L	mg/L	
Blank	IS	-	10	0	0	
	3-MPD	-				
	CycDs	-				
ML0	IS	100	S1	10	1000	1.00
	3-MPD	-				
	CycDs	-				
ML1	IS	100	S1	10	1000	1.00
	3-MPD	100	S2		100	0.10
	CycDs	50	S1		500	0.50
ML2	IS	100	S1	10	1000	1.00
	3-MPD	25	S1		250	0.25
	CycDs	100	S1		1000	1.00
ML3	IS	100	S1	10	1000	1.00
	3-MPD	50	S1		500	0.50
	CycDs	20	S0		2000	2.00
ML4	IS	100	S1	10	1000	1.00
	3-MPD	100	S1		1000	1.00
	CycDs	30	S0		3000	3.00
ML5	IS	100	S1	10	1000	1.00
	3-MPD	200	S1		2000	2.00
	CycDs	40	S0		4000	4.00

6. Apparatus

- 6.1 Analytical balance. ± 0.0001 g readability.
- 6.2 Lab centrifuge (at least 4000 rpm/min)
- 6.3 Gas chromatograph.-With mass spectrometric detector, split-splitless injector,
- 6.4 Diverse precision pipettes and volumetric flasks
- 6.5 Pasteur pipettes
- 6.6 40 mL centrifugation vials
- 6.7 GC-vials (1.5 –2.0 mL)
- 6.8 Thermostat
- 6.9 Shaking machine

7. Sampling

Wine samples for the analysis should be taken in a sufficient size. Volume needed for one test sample is 10 mL. The wine used for the preparation of the matrix-calibration (5.4) shall be free of analyte.

8. Procedure

8.1. Extraction

Add 100 µL internal standard solution S1 (6.3.2) to 10 mL wine to a suitable centrifugation vial e.g. 40 mL. (This corresponds to a concentration of 1 mg/L butane-1,4-(²H)₈). Carefully add 10 g of K₂CO₃ and mix. Take care during this addition as heat is produced due to the release of CO₂. After cooling the solution to approximately 20 °C in a water bath, add 1 mL diethyl ether. Homogenise the mixture for 5 minutes using a vertical-shaking machine. Centrifuge the vials at 4000 rpm for 5 min. For better removal of the organic phase, the extract can be partially transferred into a vial with a smaller diameter. Using a Pasteur pipette, transfer the upper organic phase, composed of diethyl ether and ethanol, into a GC vial. Add approximately 120 mg of molecular sieve into the vial. Close the vial, leave for at least 2 h and shake well from time to time. The clear supernatant is transferred to a second GC vial for the GC-MS analysis.

8.2. GC-MS Analysis

Specific parameters for the GC-MS analysis are provided below. Alternative systems may be used, if they provide a similar chromatographic performance and adequate sensitivity. The chromatographic system must be able to separate the internal standard from phenylethanol, a potential interference.

Typical GC conditions

Gas chromatograph: HP 5890 or equivalent

DB-Wax (J&W) column 60 m, 0.32 mm internal diameter, 0.25 µm film thickness, 2 m capillary containment same dimensions or equivalent

Carrier gas: H₂

Flow: Pressure 60 k Pa column head

Temperature program:

90° C, 2 min., ramp at 10°C/min. up until 165° C, held for 6 min., ramp at 4° C/min to 250°C, held for 5 min.

Injection temperature: 250° C; Injected volume; 2 µL, 90 sec splitless for 90 s.

Specific MS conditions

Mass spectrometer: Finnigan SSQ 710 or equivalent

Transfer line: 280° C

Source: 150° C

MS detection:

window 1.: 0-25 min.:

14.3 min. 3-MPD: m/z 75, m/z 61

16.7 min IS: m/z 78, m/z 61

Acquisition time for each mass is 250 μ s (dwell time).

Monitor for m/z 91 the separation of the internal standard (IS) peak from phenylethanol, which also produces a fragment m/z 78.

window 2. 25-40 min.:

32-34.5 min. CycDs: m/z 57, m/z 117

Acquisition time for each mass is 250 μ s (dwell time).

It has been observed that the analysis may degrade chromatographic column. In particular, the injection of the high boiling CycDs mixture is suspected to cause irreversible damage. Injections of reference standard solutions should be avoided; analysis should be restricted to salted-out solutions with low analyte concentrations. In addition it is recommended to use a 1-2 m pre column in order to protect the analytical column. Nevertheless, the analytical column has to be considered as a consumable and must be replaced quite regularly.

9. Evaluation

9.1. Identification

Record the relative retention time of each analyte to the IS. Calculate the mean relative retention time of the analytes in the calibration standards. The relative retention time of the analyte should be the same as that of the standard within a margin of ± 0.5 %. As a confirmation criterion, an ion ratio can be calculated for each analyte from the selected ion monitoring. This ratio is 117/57 for CycDs, 75/61 for 3-MPD and 78/61 for the IS. The ratio should be within ± 20 % of that which is found in the spiked sample. Confirmation of the identity of substances by full scan using ions can also be used.

9.2. Quantification

The quantification is done by a matrix calibration curve prepared according to appropriate section. The analyte/IS area ratios of the indicated mass ratios are correlated by linear regression against the concentration of the analyte. Quantification of the CycDs is achieved by summing the peak area of all six peaks

and calculating the total content, to allow for other distributions of the six characteristic CycDs than in the standard. The following m/z values are used for quantification:

3-MPD:	m/z 75
IS:	m/z 78
CycDs:	m/z 117

9.3. Expression of results

Results should be expressed in mg/L for 3-MPD and CycDs with two decimals (e.g. 0.85 mg/L).

9.4 Limit of Detection and limit of quantification

The limit of detection (LD) and the limit of quantification (LQ) depend on the individual measurement conditions of the chemical analysis and are to be determined by the user of the method.

The limit of detection (LD) and the limit of quantification (LQ) were estimated using the instrumentation and conditions mentioned exemplarily above (s. 8) following the instructions in the resolution OENO 7-2000 (E-AS1-10-LIMDET) "Estimation of the Detection and Quantification Limits of a Method of Analysis". Along the line of the „Logic Diagram for Decision-Making“ in N° 3 the graph approach has to be applied following paragraph 4.2.2. For this purpose a part of the ion trace (m/z) chromatogram is drawn extendedly enclosing a range of a tenfold peak width at mid-height ($w_{1/2}$) of an analyte peak in a relevant part of the chromatogram. Furthermore two parallel lines are drawn which just enclose the maximum amplitude of the signal window.

The distance of these two lines gives h_{\max} , expressed in abundance units is multiplied by 3 for LD, by 10 for LQ and finally converted into concentration units by implementing the individual response factor.

3-MPD:

LD: 0,02 mg/l

LQ: 0,06 mg/l

CycDs (sum):

LD: 0,08 mg/l

LQ: 0,25 mg/l

(Note: Since the CD are a mixture of six single compounds with the same response factor - due to their chemical equality - and with h_{\max} constant in the relevant part of the chromatogram the LD and LQ for each single compound are one sixth of the figures above)

10. Precision (interlaboratory validation)

Eleven laboratories participated in the collaborative study. The participating laboratories have proven experience in the analysis of the by-products. All of them participated in the pre-trial.

Repeatability (r) and reproducibility (R) and the respective standard deviations (S_r and S_R) were found to be correlated statistically significantly with the concentration of the analytes (ANNEX: **Figures 1 and 2**), r with more than 95% probability and R with more than 99% probability for each of the analytes using the linear regression model.

The actual performance parameters can be calculated by:

3-MPD

$$S_r = 0,060 x$$

$$S_R = 0,257 x$$

x = concentration of 3-MPD [mg/L]

$$r = 0,169 x$$

$$R = 0,720 x$$

x = concentration of 3-MPD [mg/L]

CycDs

$$S_r = 0,082 x$$

$$S_R = 0,092 x + 0,070$$

x = concentration of CycDs [mg/L]

$$r = 0,230 x$$

$$R = 0,257 x + 0,197$$

x = concentration of CycDs [mg/L]

ANNEX (Interlaboratory Study)

Participants

11 international laboratories participated in the collaborative study (5). The participating laboratories have proven experience in the analysis of the by-products. All of them participated in the pre-trial:

CSL, York, UK
Unione Italiana Vini, Verona, Italy
BfR, Berlin, Germany
BLGL, Würzburg, Germany
Istituto Sperimentale per l'enologia, Asti, Italy
LUA, Speyer, Germany
Labor Dr. Haase-Aschoff, Bad Kreuznach, Germany
CLUA, Münster, Germany
Kantonales Laboratorium, Füllinsdorf, Switzerland
LUA, Koblenz, Germany
ISMAA, S. Michele all Adige, Italy

Samples

In November 2002, participating laboratories were sent 11 wine samples consisting of five sets of blind duplicates and one further single test material. Dry white wines, dry red wines and a sweet red wine were used for test materials. The samples were subjected to homogeneity testing previously (ii).

Data analysis

Statistical analysis was carried out according to the “Protocol for the Design, Conduct and Interpretation of Method Performance Studies” (iii) using a blind duplicate model.

1. Determination of outliers was assessed by Cochran, Grubbs and paired Grubbs tests.
2. Statistical analysis was performed to obtain repeatability and reproducibility data.
3. Horrat values were calculated.

Table 2. Results for 3-MPD

	Sample A White wine 0.30	Sample B Red wine ^a 0.145	Sample C White wine 0.25	Sample F Sweet red wine 0.48	Sample G White wine 0.73
Mean mg/L					
Spiked mg/L	0.30	0.12	-	-	0.80
Recovery %	100	121	-	-	91
n	10	10 ^a	10	10	10
nc	1	1 ^a	1	1	1
outliers	2	0	0	1	1
n1	7	9 ^a	9	8	8
r	0.03	-	0.05	0.08	0.13
sr	0.01	-	0.02	0.03	0.05
RSD _r %	3.20	-	7.20	5.80	6.57
Hor	0.30	-	0.60	0.50	0.59
R	0.13	0.13	0.15	0.31	0.59
sR	0.05	0.05	0.05	0.11	0.21
RSD _R %	15.50	32.67	21.20	22.70	28.91
HoR	0.80	1.53	1.10	1.30	1.72

^a Single test sample; n, nc and n1 are single results

mean arithmetic mean of the data used in the statistical analysis

n total number of sets of data submitted

nc number of results (laboratories) excluded due to non-compliance

outliers number of results (laboratories) excluded due to determination as outliers by either Cochran's or Grubbs' tests

n1 number of results (laboratories) retained in statistical analysis

S_r the standard deviation of the repeatability

RSD_r the relative standard deviation of the repeatability (S_rx100/mean)

r repeatability (2.8 x S_r)

Ho_r the Horrat value for repeatability is the observed RSD_r divided by the RSD_r value estimated from the Horwitz equation using the assumption r = 0.66R

R reproducibility (between laboratory variation) (2.8 x S_R)

S_R the standard deviation of the reproducibility

RSD_R the relative standard deviation of the reproducibility (S_Rx100/mean)

Ho_R the Horrat value for reproducibility is the observed RSD_R value divided by the RSD_R value calculated from the Horwitz equation

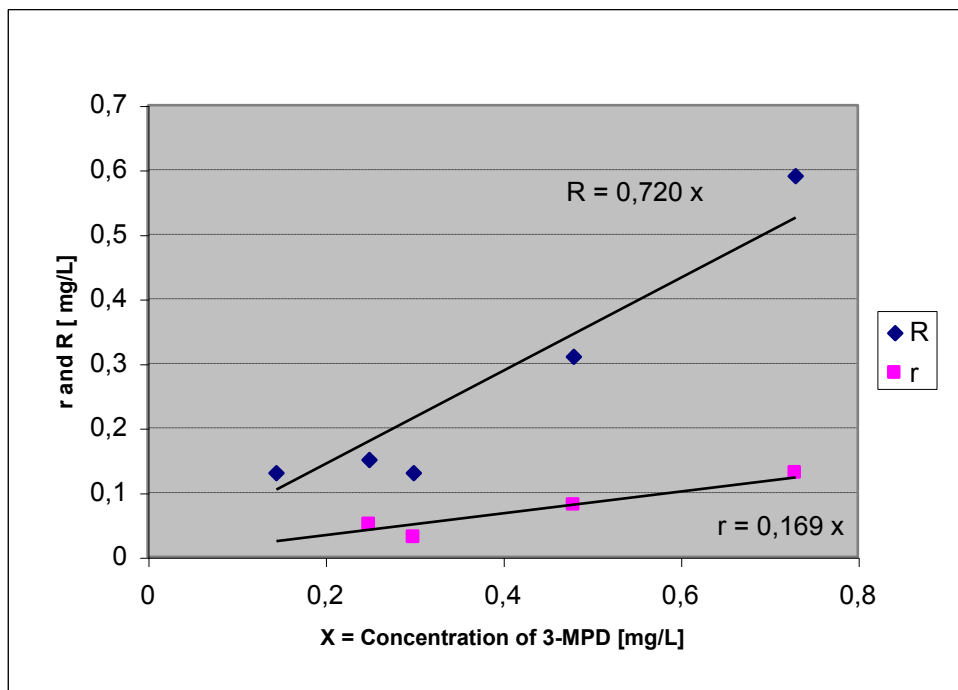

Figure 1. Correlation between 3-MPD concentration and r and R.

Table 3. Results for cyclic dyglycerols

	Sample A	Sample B	Sample D	Sample F	Sample G
	White	Red	Red	Sweet red	White
Mean mg/L	wine	wine^a	wine	wine	wine
	1.55	0.593	0.80	0.96	0.56
Spiked mg/L	1.50	0.53			0.50
Recovery %	103	113			112
n	11	11 ^a	11	11	11
nc	0	0	0	0	0
outliers	2	0	1	2	1
nI	9	11 ^a	10	9	10
r	0.37	-	0.19	0.18	0.15
sr	0.13	-	0.07	0.07	0.05
RSDr %	8.50	-	8.60	6.70	9.30
Hor	0.90	-	0.80	0.60	0.80
R	0.61	0.379	0.39	0.41	0.34
sR	0.22	0.135	0.13	0.15	0.12
RSDR %	14.00	22.827	17.30	15.20	21.50
HoR	0.90	1.319	1.00	0.90	1.20

^a Single test sample; n and nc are single results

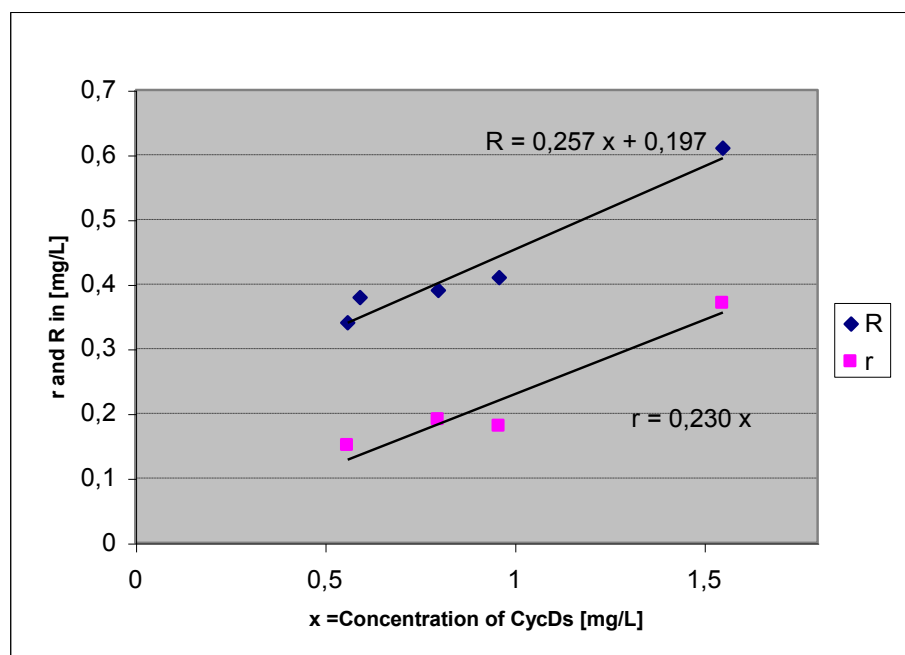

Figure 2. Correlation between CycDs concentration and r and R.

- (1) Bononi, M., Favale, C., Lubian, E., Tateo F. (2001)
A new method for the identification of cyclic diglycerols in wine
J. Int. Sci. Vigne Vin. 35, 225-229
- (2) Thompson, M. and Wood, R. (1993)
International Harmonised Protocol for the Proficiency Testing of
(Chemical) Analytical Laboratories - J AOAC Int 76, 926-940
- (3) Horwitz, W. (1995)
Protocol for the design, conduct and interpretation of method-
performance studies
Pure and Applied Chemistry 67, 331-343

**Determination of releasable 2,4,6-trichloroanisole
in wine by cork stoppers**
(Resolution OIV-Oeno 296/2009)

1 SCOPE:

The method of determination of releasable 2,4,6-trichloroanisole (TCA) by cork stoppers measures the quantity of TCA released by a sample of cork stoppers macerated in a aqueous-alcoholic solution. The aim of this method is to evaluate the risk of releasing by the lot of analyzed cork stoppers and to provide a method for controlling the quality of cork stoppers.

2 PRINCIPLE

The method aims to simulate 2,4,6-trichloroanisole migration phenomena susceptible of being produced between the cork stopper and wine in bottles. Cork stoppers are macerated in a wine or a aqueous-alcoholic solution, until a balance is obtained. The TCA of the head space is sampled from an appropriate part of the macerate by the solid-phase micro-extraction technique (SPME), then analyzed by gas chromatography, with detection by mass spectrometer (or by electron-capture detector).

3 REAGENTS AND PRODUCTS

3.1 White wine with an alcoholic strength ranging between 10 and 12 % vol. (It can be replaced by an aqueous-alcoholic solution with an alcoholic strength of 12 % vol). The wine and/or the aqueous-alcoholic solution must be free of TCA.

3.2 Sodium chloride ≥ 99.5 %

3.3 2,4,6-trichloroanisole (TCA)-d₅ purity $\geq 98\%$ for GC/MS; 2,6-dibromoanisole or 2,3,6-trichloroanisole purity ≥ 99 % for GC/ECD

3.4 2,4,6-trichloroanisole (TCA) purity $\geq 99.0\%$

3.5 Absolute ethanol

3.6 Pure de-ionised water void of TCA (Standard EN ISO 3696)

3.7 Aqueous-alcoholic solution at 12 % vol.

Prepared using absolute ethanol (3.5) and de-ionised water void of TCA (3.6).

3.8 Internal standard stock solution (500 mg/L)

Add either 0.050 g of 2,4,6-trichloroanisole-d₅ (or 2,6-dibromoanisole or 2,3,6-trichloroanisole (3.3) to approximately 60 ml of absolute ethanol (3.5). After dissolution, adjust the volume to 100 mL with absolute ethanol (3.5). It can be kept in a glass bottle with a metallic or glasscover.

3.9 Intermediate solution of internal standard (5.0 mg/L)

Add 1 mL of a solution of either 2,4,6-trichloroanisole-d₅ (or 2,6-dibromoanisole or 2,3,6-trichloroanisole) at 500 mg/L (3.8) to approximately 60 mL of absolute ethanol (3.5). Adjust the volume to 100 mL with absolute ethanol (3.5). It can be kept in a glass bottle with a metallic or glass cover.

3.10 Internal standard solution (2.0 µg/L)

Add 40 µL of a solution of either 2,4,6-trichloroanisole-d₅ (or 2,6-dibromoanisole or 2,3,6 trichloroanisole) at 5.0 mg/L (3.9) to approximately 60 mL of absolute ethanol (3.5). Adjust the volume to 100 ml with absolute ethanol (3.5). It can be kept at an ambient temperature in a glass bottle with a metallic or glass cover.

3.11 Stock solution of TCA standard (40 mg/L)

Add 0.020g of 2,4,6-trichloroanisole to approximately 400 ml of absolute ethanol (3.5). Following dissolution, adjust volume to 500 mL with absolute ethanol (3.5).

3.12 Intermediate solution A of TCA standard (80 µg/L)

Add 1 mL of 2,4,6-trichloroanisole solution at 40 mg/L (3.11) to approximately 400 mL of absolute ethanol (3.5). Following dissolution, adjust volume to 500 mL with absolute ethanol (3.5).

3.13 Intermediate solution B of TCA standard (160 ng/L)

Add 1 mL of solution 2,4,6-trichloroanisole at 80 µg/L (3.12) to approximately 400 mL of pure de-ionised water (3.6). Following dissolution, adjust the volume to 500 mL with pure de-ionised water (3.6)

3.14 Use the standard-addition technique to make up a range of standard solutions of TCA. Standard solutions in the range from 0.5 ng/L to 50 ng/L can be used, by making additions with a solution of 2,4,6-trichloroanisole at 160 ng/L (3.13) to 6 ml of absolute ethanol (3.5). Following dissolution, adjust volume to 50 mL with pure de-ionised water (3.6)

The calibration curve obtained should be evaluated regularly and in any case whenever there is a major change in the GC/MS or GC/ECD systems.

3.15 Carrier gas: Helium, chromatographic purity (≥ 99.9990 %)

4. APPARATUS

- 4.1 Laboratory glassware
 - 4.1.1 Graduated 100-mL flask
 - 4.1.2 100- μ L microsyringe
 - 4.1.3 Wide-neck glass jar of a capacity adapted to the sample size, closed with a glass or metallic stopper or a material which does not bind TCA.
 - 4.1.4 20-mL glass sample bottle closed with a perforated capsule and a liner with one side Teflon-coated.
- 4.2 Solid-phase microextraction system (SPME) with a fiber coated with a polydimethylsiloxane film 100 μ m thick
- 4.3 Heating system for sample bottle (4.1.4)
- 4.4 Stirring system for sample bottle (4.1.4)
- 4.5 Gas chromatograph equipped with a "split-splitless" injector and a mass spectrometer detector (MS) or an electron-capture detector (ECD)
- 4.6 Data-acquisition system
- 4.7 If required, an automatic sampling and injection system operating with an SPME system
- 4.8 Capillary column coated with an apolar stationary phase, of the phenylmethylpolysiloxane type (e.g.: 5 % phenyl methylpolysiloxane, 30 m x 0,25 mm x 0,25 μ m film thickness or equivalent.)

5. SAMPLE PREPARATION

The corks are placed whole in a glass closed container. The container capacity (4.1.3), the same as the quantity of wine or aqueous-alcoholic solution (3.1 or 3.7), must be chosen in accordance to the sample size while ensuring that the corks are completely covered and immersed in the maceration container.

Example 1: 20 corks (45x24) mm, in a 1 L container;

Example 2: 50 corks (45x24) mm, in a 2 L container.

Most of the TCA released during maceration of the groups of stoppers is generally derived from a very low percentage of these stoppers. In order to obtain the best representation of a batch of stoppers, a number of appropriate analyses according to sampling rules and risk with regard to wine contamination should be carried out.

6. OPERATING METHOD

- 6.1 Extraction

After macerating at ambient temperature for (24 ± 2) hours under laboratory ambient temperature conditions, the maceration is homogenized by inversion. A part of the aliquot of the 10ml maceration solution (5) is transferred to a glass sample bottle (4.1.4)

To increase extraction efficiency and subsequent sensitivity of the method, a quantity of approximately 1 g of sodium chloride (3.2) can be added. 50 μ L of the internal standard solution at 2.0 μ g/L (3.10) are immediately added, then the bottle is closed using a perforated metal capsule fitted with a silicone / Teflon-coated liner. The capsule is crimped. The contents of the bottle are homogenized for 10 minutes by mixing using a stirring system (4.4) or by using an automatic system (4.7).

The bottle containing the sample is placed in the heating system (4.3) set to $35 \text{ }^\circ\text{C} \pm 2 \text{ }^\circ\text{C}$, with stirring (4.4). The extraction of the headspace is carried out using the SPME system (4.2) for at least 15 minutes.

6.2 Analysis

The fiber is then desorbed at $260 \text{ }^\circ\text{C}$ for at least 2 minutes in the injector of a gas chromatograph, in splitless mode (4.5). The separation is carried out using a capillary column with a non-polar stationary phase (4.8). The carrier gas is helium with a constant flow of 1 ml/min. A temperature program from $35 \text{ }^\circ\text{C}$ (for 3 min) to $265 \text{ }^\circ\text{C}$ (at $15 \text{ }^\circ\text{C}/\text{min}$) is given as an example.

6.3 Detection and quantification

Detection is carried out by mass spectrometry with a selection of specific ions for the 2,4,6-trichloroanisole (ions m/z 195, 210, 212), quantified on the m/z 195 ion, and the internal standard 2,4,6-trichloroanisole- d_5 (ions m/z 199, 215, 217) quantified on ion m/z 215..

For the determination of ECD, identify the analyte and internal standard (2,6-dibromoanisole or 2,3,6 trichloroanisole) in the chromatogram, by comparing the retention time of the sample peak corresponding to that of the standard solution peak.

7. CALCULATIONS

The area of the chromatographic peak obtained for the 2,4,6-trichloroanisole is corrected by the area obtained for the chromatographic peak of the internal standard. The content in 2,4,6-trichloroanisole of each sample is obtained using a calibration curve. The points on this curve are obtained by tracing the relative responses of the 2,4,6-trichloroanisole/internal standard, obtained for

aqueous-alcoholic solutions (3.7) containing known concentrations of 2,4,6-trichloroanisole, as a function of the concentrations of these solutions (3.14).

The results are given in ng/L of TCA present in the maceration, rounded off to the nearest 0.1 ng/L.

8. CHARACTERISTICS OF THE METHOD

As an indication, the detection limit of the analysis of the macerations must be lower than 0.5 ng/L, and the quantification limit close to 1 ng/L. The coefficient of variation is lower than 5% for 5 ng/L, when the selected internal standard is the deuterated analogue TCA-d₅.

An interlaboratory trial was carried out in order to validate the method. This interlaboratory trial was not carried out according to the OIV protocol and the validation parameters mentioned in the FV 1224.

9. BIBLIOGRAPHY

HERVÉ E., PRICE S., BURNS G., Chemical analysis of TCA as a quality control tool for natural corks. *ASEV Annual Meeting*. 1999.

ISO standard 20752:2007 Cork stoppers — Determination of releasable 2, 4, 6-trichloroanisole (TCA).

FV 1224 - Résultats de l'analyse collaborative Ring test 3-TCA SPME.

Method OIV-MA-AS315-17

Type IV method

**Determining the presence and content of polychlorophenols
and polychloroanisols in wines, cork stoppers, wood and
bentonites used as atmospheric traps**
(Resolution OIV-Oeno 374/2009)

1. SCOPE

All wines, cork stoppers, bentonites (absorption traps) and wood.

2. PRINCIPLE

Determination of 2,4,6-trichloroanisole, 2,4,6-trichlorophenol, 2,3,4,6-tetrachloroanisole, 2,3,4,6-tetrachlorophenol, pentachloroanisole and pentachlorophenol by gas chromatography, by injecting a hexane extract of the wine and an ether/hexane extract of the solid samples to be analyzed and internal calibration.

3. REAGENTS

Preliminary remark: all the reagents and solvents must be free of the compounds to be determined listed in 2 at the detection limit.

3.1 Purity of hexane > 99 %

3.2 Purity of ethylic ether > 99 %

3.3 Ether/hexane mixture (50/50; v/v)

3.4 or 2,5-dibromophenol purity \geq 99 %

3.5 Pure ethanol

3.6 Pure deionized water, TCA free, type II in accordance with ISO standard EN 3696

3.7 50 % vol. aqueous-alcoholic solution. Place 100 ml of absolute ethanol (3.<5) in a graduated 200-ml flask (4.9.9), add 200 ml of deionized water (3.6), and homogenize.

3.8 Internal standard:

3.8.1 200 mg/l stock solution. Place 20 mg of internal standard (3.4) in a graduated 100-ml flask (4.9.8), add the 50 % volume aqueous-alcoholic solution (3.7) and homogenize.

3.8.2 Internal standard solution (2 mg/l). Place 1 ml of the stock solution of internal standard (3.8.1) in a graduated 100-ml flask (4.9.8), add the 50% vol aqueous-alcoholic solution (3.7) and homogenize.

3.8.3 Internal standard solution (20 µg/l). Place 1 ml of stock solution of internal standard (3.8.2) in a 100 ml graduated flask (4.9.8), add with 50 % vol aqueous-alcoholic solution

3.9 Pure products

3.9.1 2,4,6-trichloroanisole: ≥ 99 %, case: 87-40-1

3.9.2 2, 4, 6-trichlorophenol: ≥ 99.8 %, case: 88-06-2

3.9.3 2,3,5,6-tetrachloroanisole: ≥ 99 %, case: 6936-40-9 (note: the product sought in the samples is 2,3,4,6-tetrachloroanisole but it does not exist on the market)

3.9.4 2, 3, 4, 6-tetrachlorophenol: ≥ 99 %, case: 58-90-2

3.9.5 pentachloroanisole: ≥ 99 %, case: 1825-21-1

3.9.6 pentachlorophenol: 99 %, case: 87-86-5

3.10 Reagents for derivatisation - Piridine: acetic anhydride (1:0,4) vol.

3.10.1 Piridine: ≥ 99 %

3.10.2 Acetic anhydride: ≥ 98 %

3.11 Calibration stock solution at 200 mg/l

In a graduated 100-ml flask (4.9.8), place approximately 20 mg of the pure reference products (3.9.1 to 3.9.6) but whose exact weight is known (4.7), add absolute ethanol (3.5). Homogenize.

3.12 Intermediate calibration solution at 200 µg/l

In a graduated 100-ml flask (4.9.8) filled with absolute ethanol (3.5), add 100 µl of the calibration stock solution at 200 mg/l (3.11) using the 100-µl micro-syringe (4.9.1) and homogenize.

3.13 Calibration surrogate solution at 4 µg/l

In a graduated 50-ml flask (4.9.7) containing 50 % vol aqueous-alcoholic solution (3.7) add 1 ml of the intermediate calibration solution at 200 µg/l (3.11) using a 1-ml pipette (4.9.6). Add to volume 50 ml with pure ethanol (3.5) and homogenize.

3.14 Calibration solutions. It is possible to prepare various standard solutions with various concentrations by adding, using the 100-µl micro-syringe of (4.9.1), for example 50 µl of the surrogate calibration solution at 4 µg/l (3.12) to 50 ml of wine to enrich it with 4 ng/l of the substances to be determined.

The same reasoning can be used to prepare calibration solutions of various concentrations, either using aqueous-alcoholic solutions, or wine, or to enrich an extraction medium with a known quantity of pure products.

3.15 Commercially available Bentonite.

4. APPARATUS

4.1 Gas phase chromatograph with Split-splitless injector coupled to an electron capture detector. (It is likewise possible to use a mass spectrometer)

4.2 Capillary tube of non-polar steady-state phénylmethylpolysiloxane type: (0.32 mm x 50 m, thickness of film 0.12 µm or the equivalent)

4.3 Chromatographic conditions, as an example:

4.3.1 Injection in "split-splitless" mode (valve closing time 30 seconds)

4.3.2 Carrier gas flow rate: 30 ml/min including 1 ml in the column Hydrogen U ®² (It is likewise possible to use helium)

4.3.3 Auxiliary gas flow rate: 60 ml/min – Nitrogen with chromatographic purity (≥ 99,9990 %). It is also possible to use argon methane.

4.3.4 Furnace gradient temperature for information purposes:

- from 40 °C to 160 °C at a rate of 2 °C/min

- from 160 °C to 200 °C at a rate of 5 °C/min

- step at 220 °C for 10 min

4.3.5 Injector temperature: 250 °C

4.3.6 Detector temperature: 250 °C

4.4 Acquisition and integration: acquisition is by computer. The peaks of the various compounds identified by comparison with the reference are then integrated.

4.5 Magnetic agitator.

4.6 Vortex with adaptation for 30-ml flask (4.9.3)

4.7 Precision balance to within 0.1 mg

4.8 Manual or electric household grate

4.9 Laboratory equipment:

4.9.1 100-µl micro-syringe

4.9.2 10-µl micro-syringe

4.9.3 30-ml flask closing with a screwed plug and cover with one side Teflon-coated

4.9.4 10-ml stick pipette graduated 1/10 ml

4.9.5 5-ml stick pipette graduated 1/10 ml

4.9.6 1-ml precision pipette

4.9.7 Graduated 50-ml flask

- 4.9.8 Graduated 100-ml flask
- 4.9.9 Graduated 200-ml flask
- 4.9.10 100-ml separating funnel
- 4.9.11 Pasteur pipettes and suitable propipette pear
- 4.9.12 Household aluminum foil, roll-form.
- 4.9.13 Centrifuge

5. SAMPLE PREPARATION

- 5.1 The stopper is grated (4.8) or cut into pieces (dimension < 3 mm)
- 5.2 Wood is cut with a clipper to obtain pieces (dimension < 3 mm)
- 5.3 The bentonite (3.15) (30 g for example) is spread out over a strip of aluminum foil (4.9.12) of approximately 30 cm x 20 cm and is exposed to the atmosphere to be analyzed for at least 5 days.

6. OPERATING METHOD

- 6.1 Extraction process for solid samples:
 - 6.1.1 Stopper: in a 30-ml flask (4.9.3), place approximately 1 g of grated stopper (5.1) but of a precisely known weight (4.7)
 - 6.1.2 Wood: in a 30-ml flask (4.9.3), place approximately 2 g of wood chips (5.2) but of a precisely known weight (4.7)
 - 6.1.3 Control Bentonite: in a 30-ml flask (4.9.3), place approximately 5 g of bentonite (3.15) but of a precisely known weight (4.7)
 - 6.1.4 Sample bentonite: in a 30-ml flask (4.9.3), place approximately 5 g of bentonite (5.3) of a precisely known weight (4.7)
 - 6.1.5 Add 10 ml (4.9.4) of ether/hexane mixture (3.3)
 - 6.1.7 Add with the micro-syringe (4.9.1) 50 µl of the internal standard solution (3.8.2)
 - 6.1.8 Agitate with the vortex (4.6) for 3 min
 - 6.1.9 Recover the ether/hexane liquid phase in a 30-ml flask (4.9.3)
 - 6.1.10 Repeat the extraction operation on the sample with 2 times 5 ml of ether/hexane mixture (3.3)
 - 6.1.11 Final extract: mix the 3 phases of ether/hexane.
- 6.2 Extraction of the wine and calibration solution
 - 6.2.1 Sample 50 ml of wine or calibration solution (using the graduated flask (4.9.7)
 - 6.2.2 Place them in the 100-ml graduated flask (4.9.8)
 - 6.2.3 Add with the microsyringe (4.9.1) 50 µl of internal standard (3.8.3)
 - 6.2.4 Add 4 ml (4.9.5) of hexane (3.1)

- 6.2.5 Carry out the extraction using the magnetic stirrer (4.5) for 5 min.
- 6.2.6 Elutriate into the funnel (4.9.10)
- 6.2.7 Recover the organic phase with the emulsion in a 30-ml flask (4.9.3) and aqueous phase in the 100-ml graduated flask (4.9.8)
- 6.2.8 Repeat the extraction of the wine or calibration solution using 2 ml of hexane (3.1)
- 6.2.9 Carry out the extraction using the magnetic stirrer (4.5) for 5 min.
- 6.2.10 Elutriate into the funnel (4.9.10)
- 6.2.11 Recover the organic phase with the emulsion in the same 30-ml flask mentioned in 6.2.7 (containing the organic phase obtained upon the first extraction)
- 6.2.12 Break the emulsion of the organic phase by centrifugation (4.9.13) by eliminating the lower aqueous phase using a Pasteur pipette (4.9.11) fitted with a propipette pear.
- 6.2.13 Final wine extract and calibration solutions: the residual organic extract

6.3 Analyze:

- 6.3.1 Add final extract (6.1.11 or 6.2.13) 100 µl (4.9.1) of the pyridine acetic anhydride reagent mixture (3.10) for the derivatisation.
- 6.3.2 Mix using a magnetic stirrer (4.5) for 10 min.
- 6.3.3 Inject 2 µl of derivatised final extract (6.3.2) into the chromatograph

7. CALCULATION:

$\text{Concentration of product} = \frac{\text{Product peak area}}{\text{Peak area of internal standard}} * \text{Response factor}$

Response factor = concentration of calibration solution (3.13) * (Peak area of the internal standard / *(Peak area of the pure product in the calibration solution).

Check the calibration by ensuring the response factors +/- 10 %.

8. RESULTS

The results are expressed in ng/l for the wine and ng/g for the cork stoppers, bentonites and wood.

9. CHARACTERISTICS OF THE METHOD

9.1 Coverage rate

The coverage rate calculated in relation to the quantities added in terms of wood chips, polychloroanisols and polychlorophenols of 115 ng/g is:

- 2,4,6-trichloroanisol: 96 %
- 2,4,6-trichlorophenol: 96 %
- 2,3,4,6-tetrachloroanisol: 96 %
- 2,3,4,6-tetrachlorophenol: 97 %
- pentachloroanisol: 96 %
- pentachlorophenol: 97 %

9.2 Measurement repeatability

Calculated for each product, the uncertainties are as follows:

In a stopper ng/g	Mean	Standard deviation	Repeatability
2,4,6-trichloroanisol	1.2	0.1	0.28
2,4,6-trichlorophenol	26	3.3	9.24
2,3,4,6-tetrachloroanisol	1.77	0.44	1.23
2,3,4,6-tetrachlorophenol	2.59	0.33	0.92
pentachloroanisol	23.3	2.9	8.12
pentachlorophenol	7.39	1.91	5.35

In wood with 23 ng/g	Standard deviation	Repeatability
2,4,6-trichloroanisol	1.9	5.3
2,4,6-trichlorophenol	1.9	5.3
2,3,4,6-tetrachloroanisol	2.6	7.4
2,3,4,6-tetrachlorophenol	3.3	9.3
pentachloroanisol	2.7	7.5
pentachlorophenol	3.6	10.1

In wine with 10 ng/l	Standard deviation	Repeatability
2,4,6-trichloroanisol	0,4	1,1
2,4,6-trichlorophenol	2,1	5,9
2,3,4,6-tetrachloroanisol	0,6	1,7
2,3,4,6-tetrachlorophenol	4	11,2
pentachloroanisol	1,2	3,4
pentachlorophenol	6,5	18,2

COMPENDIUM OF INTERNATIONAL ANALYSIS OF METHODS - OIV
Polychlorophenols, Polychloroanisols

In bentonite with 15ng/g	Standard deviation	Repeatability
2,4,6-trichloroanisol	0,9	2,5
2,4,6-trichlorophenol	4	11,2
2,3,4,6-tetrachloroanisol	1,2	3,4
2,3,4,6-tetrachlorophenol	5,2	14,6
pentachloroanisol	4,3	12,0
pentachlorophenol	12,1	33,9

9.3 Detection limits (DL) and quantification limits (QL) calculated according to the OIV method:

9.3.1 Wood

	DL in ng/g	QL in ng/g
2,4,6-trichloroanisol	0.72	2.4
2,4,6-trichlorophenol	0.62	2.0
2,3,4,6-tetrachloroanisol	0.59	2.0
2,3,4,6-tetrachlorophenol	1.12	3.74
pentachloroanisol	0.41	1.4
pentachlorophenol	0.91	3.1

9.3.2 Bentonite

	DL in ng/g	QL in ng/g
2,4,6-trichloroanisol	0.5	1
2,4,6-trichlorophenol	1	3
2,3,4,6-tetrachloroanisol	0.5	1
2,3,4,6-tetrachlorophenol	1	3
pentachloroanisol	0.5	1
pentachlorophenol	Not det.	Not det.

9.3.3 Stopper

	DL in ng/g	QL in ng/g
2,4,6-trichloroanisol	0.5	1.5
2,4,6-trichlorophenol	1	2
2,3,4,6-tetrachloroanisol	0.5	1.5
2,3,4,6-tetrachlorophenol	1	2
pentachloroanisol	0.5	1.5
pentachlorophenol	1	2

COMPENDIUM OF INTERNATIONAL ANALYSIS OF METHODS - OIV
Polychlorophenols, Polychloroanisols

9.3.4 Wine

	DL in ng/l	QL in ng/l
2,4,6-trichloroanisol	0.3	1
2,4,6-trichlorophenol	1	3
2,3,4,6-tetrachloroanisol	0.3	1
2,3,4,6-tetrachlorophenol	0.3	1
pentachloroanisol	0.5	3
pentachlorophenol	1	3

®² Air Liquide

Method OIV-MA-AS315-18

Type II method

Analysis of biogenic amines in musts and wines using HPLC

(Resolution OIV-Oeno 346/2009)

1. SCOPE

This method can be applied for analysing biogenic amines in musts and wines:

Ethanolamine: up to 20 mg/l
Histamine: up to 15 mg/l
Methylamine: up to 10 mg/l
Serotonin: up to 20 mg/l
Ethylamine: up to 20 mg/l
Tyramine: up to 20 mg/l
Isopropylamine: up to 20 mg/l
Propylamine: normally absent
Isobutylamine: up to 15 mg/l
Butylamine: up to 10 mg/l
Tryptamine: up to 20 mg/l
Phenylethylamine: up to 20 mg/l
Putrescine or 1,4-diaminobutane: up to 40 mg/l
2-Methylbutylamine: up to 20 mg/l
3-Methylbutylamine: up to 20 mg/l
Cadaverine or 1,5-diaminopentane: up to 20 mg/l
Hexylamine: up to 10 mg/l

2. DEFINITION

The biogenic amines measured are:

Ethanolamine: C_2H_7NO – CAS [141 – 43 – 5]
Histamine: $C_5H_9N_3$ - CAS [51 – 45 – 6]
Methylamine: CH_5N – CAS [74 – 89 – 5]
Serotonin: $C_{10}H_{12}N_2O$ – CAS [153 – 98 – 0]
Ethylamine: C_2H_7N – CAS [557 – 66 – 4]
Tyramine: $C_8H_{11}NO$ - CAS [60 – 19 – 5]
Isopropylamine: C_3H_9N - CAS [75 – 31 – 0]
Propylamine: C_3H_9N – CAS [107 – 10 – 8]
Isobutylamine: $C_4H_{11}N$ – CAS [78 – 81 – 9]
Butylamine: $C_4H_{11}N$ – CAS [109 – 73 – 9]

Tryptamine: $C_{10}H_{12}N_2$ – CAS [61 – 54 – 1]
Phenylethylamine: $C_8H_{11}N$ – CAS [64 – 04 – 0]
Putrescine or 1,4-diaminobutane: $C_4H_{12}N_2$ – CAS [333 – 93 – 7]
2-Methylbutylamine: $C_5H_{13}N$ - CAS [96 – 15 – 1]
3-Methylbutylamine: $C_5H_{13}N$ - CAS [107 – 85 – 7]
Cadaverine or 1,5-diaminopentane: $C_5H_{14}N_2$ – CAS [1476 – 39 – 7]
1,6-Diaminohexane: $C_6H_{16}N_2$ – CAS [124 – 09 – 4]
Hexylamine: $C_6H_{15}N$ – CAS [111 – 26 – 2]

3. PRINCIPLE

The biogenic amines are directly determined by HPLC using a C_{18} column after O-phthalaldehyde (OPA) derivatization and fluorimetric detection.

4. REAGENTS AND PRODUCTS

- 4.1 High purity resistivity water ($18M\Omega \cdot cm$)
- 4.2 Dihydrate disodium hydrogenophosphate - purity $\geq 99\%$
- 4.3 Acetonitrile - Transmission minimum at 200 nm - purity $\geq 99\%$
- 4.4 O-phthalaldehyde (OPA) - Application for fluorescence - purity $\geq 99\%$
- 4.5 Disodium tetraborate decahydrate - purity $\geq 99\%$
- 4.6 Methanol - purity $\geq 99\%$
- 4.7 Hydrochloric acid 32 %
- 4.8 Sodium hydroxide pellets - purity $\geq 99\%$
- 4.9 Ethanolamine - Purity $\geq 99\%$
- 4.10 Histamine dichlorhydrate - Purity $\geq 99\%$
- 4.11 Ethylamine chlorhydrate - Purity $\geq 99\%$
- 4.12 Serotonin - Purity $\geq 99\%$
- 4.13 Methylamine chlorhydrate – Purity $\geq 98\%$
- 4.14 Tyramine chlorhydrate - Purity $\geq 99\%$
- 4.15 Isopropylamine purity $\geq 99\%$
- 4.16 Butylamine - Purity $\geq 99\%$
- 4.17 Tryptamine chlorhydrate - purity $\geq 98\%$
- 4.18 Phenylethylamine - Purity $\geq 99\%$
- 4.19 Putrescine dichlorhydrate - Purity $\geq 99\%$
- 4.20 2-Methylbutylamine - Purity $\geq 98\%$
- 4.21 3-Methylbutylamine - Purity $\geq 98\%$
- 4.22 Cadaverine dichlorhydrate - Purity $\geq 99\%$
- 4.23 1-6-Diaminohexane - Purity $\geq 97\%$
- 4.24 Hexylamine - Purity $\geq 99\%$

- 4.25 Nitrogen (maximum impurities: $\text{H}_2\text{O} \leq 3 \text{ mg/l}$; $\text{O}_2 \leq 2 \text{ mg/L}$; $\text{C}_n\text{H}_m\text{s} \leq 0.5 \text{ mg/l}$)
- 4.26 Helium (maximum impurities: $\text{H}_2\text{O} \leq 3 \text{ mg/l}$; $\text{O}_2 \leq 2 \text{ mg/L}$; $\text{C}_n\text{H}_m \leq 0.5 \text{ mg/l}$)

Preparation of reagent solutions:

4.27 Preparation of eluents

Phosphate solution A: Weigh $11.12 \text{ g} \pm 0.01 \text{ g}$ of di-basic sodium phosphate (4.2) in a 50-ml beaker (5.5) on a balance (5.27). Transfer to a 2-litre volumetric flask (5.9) and make up to 2 litres with high purity water (4.1). Homogenize using a magnetic stirrer (5.30) and filter over a $0.45 \mu\text{m}$ membrane (5.17). Put in the 2-litre bottle (5.12).

Solution B: The acetonitrile (4.3) is used directly.

4.28 OPA solution – Daily preparation

Weigh $20 \text{ mg} \pm 0.1 \text{ mg}$ of OPA (4.4) in a 50-ml flask (5.7) on the precision balance (5.27). Make up to 50 ml with methanol (4.6). Homogenize.

4.29 Preparation of the borate buffer (4.29) – Weekly preparation

Weigh $3.81 \text{ g} \pm 0.01 \text{ g}$ of $\text{Na}_2\text{B}_4\text{O}_7 \cdot 10\text{H}_2\text{O}$ (4.5) in a 25-ml beaker (5.6) on the precision balance (5.27). Transfer to a 100-ml volumetric flask (5.8) and make up to 100 ml with demineralised water (4.1). Homogenize with a magnetic stirrer (5.30), transfer to a 150-ml beaker (5.4) and adjust to pH 10.5 using a pH meter (5.28 and 5.29) with 10 N soda (4.8).

4.30 0.1 M hydrochloric acid solution: Put a little demineralised water (4.1) into a 2-litre volumetric flask (5.9). Add 20 ml of hydrochloric acid (4.7) using a 10-ml automatic pipette (5.24 and 5.25)

4.31 Calibration solution in 0.1 M hydrochloric acid

Guideline concentration of the calibration solution - weigh at $\pm 0.1 \text{ mg}$

COMPENDIUM OF INTERNATIONAL METHODS OF ANALYSIS-OIV
Biogenic amines

	Indicative final concentration in the calibration mix in mg/l
Ethanolamine	5
Histamine	5
Methylamine	1
Serotonin	20
Ethylamine	2
Tyramine	7
Isopropylamine	4
Propylamine	2.5
Isobutylamine	5
Butylamine	5
Tryptamine	10
Phenylethylamine	2
Putrescine	12
2- Methylbutylamine	5
3- Methylbutylamine	6
Cadaverine	13
1,6 Diaminohexane	8
Hexylamine	5

The true concentration of the calibration solution is recorded with the batch number of the products used.

Certain biogenic amines being in salt form, the weight of the salt needs to be taken into account when determining the true weight of the biogenic amine.

The stock solution is made in a 100-ml volumetric flask (5.8).

The surrogate solution is made in a 250-ml volumetric flask (5.10).

4.32 1,6 Diaminohexane internal standard

Weigh exactly 119 mg in a 25-ml Erlenmeyer flask (5.1) on a balance (5.26).

Transfer to a 100-ml volumetric flask (5.8) and top up to the filling mark with 0.1 N hydrochloric acid (4.30).

4.33 2-Mercaptoethanol - Purity \geq 99 %.

5. APPARATUS

- 5.1 25-ml Erlenmeyer flasks
- 5.2 250-ml Erlenmeyer flasks
- 5.3 100-ml beakers
- 5.4 150-ml beakers
- 5.5 50-ml beaker
- 5.6 25-ml beaker
- 5.7 50-ml volumetric flasks
- 5.8 100-ml volumetric flasks
- 5.9 2,000-ml volumetric flasks
- 5.10 250-ml volumetric flask
- 5.11 1-litre bottles
- 5.12 2-litre bottle
- 5.13 2-ml screw cap containers suitable for the sample changer
- 5.14 50-ml syringe
- 5.15 Needle
- 5.16 Filter holder
- 5.17 0.45 μ m cellulose membrane
- 5.18 0.8 μ m cellulose membrane
- 5.19 1.2 μ m cellulose membrane
- 5.20 5 μ m cellulose membrane
- 5.21 Cellulose pre-filter
- 5.22 1-ml automatic pipette
- 5.23 5-ml automatic pipette
- 5.24 10-ml automatic pipette
- 5.25 Cones for 10-ml, 5-ml and 1-ml automatic pipettes
- 5.26 Filtering system
- 5.27 Balances for weighing 0 to 205 g at \pm 0.01 mg
- 5.28 pH meter
- 5.29 Electrode
- 5.30 Magnetic stirrer
- 5.31 HPLC pump
- 5.32 Changer-preparer equipped with an oven

Note: An oven is indispensable, if a changer-preparer is used for injecting several samples one after another. This operation may likewise be done manually) the results may be less precise;

- 5.33 Injection loop
5.34 5 µm C₁₈ column, 250 mm × 4 (which must lead to a similar chromatogram as presented in annex B);
5.35 Fluorimetric detector
5.36 Integrator
5.37 Borosilicic glass tube with a stopper and closure cap covered with PTFE (ex Sovirel 15).

6. PREPARATION OF SAMPLES

Samples are previously purged of gas with nitrogen (4.25).

6.1 Filtering

Filter approximately 120 ml of the sample over membrane:

- for a wine: 0.45 µm (5.17),
- for a must or non-clarified wine: 0.45 (5.17) – 0.8 (5.18) – 1.2 (5.19) - 5 µm (5.20) + pre-filter (5.21), pile filters in the following order, the sample pushed by the top: 0.45 µm (5.17) + 0.8 µm (5.18) + 1.2 µm (5.19) + 5 µm (5.20) + prefiltered (5.21)

6.2 Preparation of the sample

Put 100 ml of the sample (6.1) into a 100-ml volumetric flask (5.8);
Add 0.5 ml of 1-6-diaminohexane (4.32) at 119 mg/100 ml using a 1-ml automatic pipette (5.21 and 25);
Draw off 5 ml of the sample using the pipette (5.23 and 5.25); pour this into a 25-ml Erlenmeyer flask (5.1);
Add 5 ml of methanol to this (4.6) using the pipette (5.23 and 5.25);
Stir to homogenize;
Transfer to containers (5.13);
Start the HPLC pump (5.31), then inject 1 µl (5.32 and 5.33)

6.3 Derivatisation

In a borosilicic glass tube (5.37), pour 2 ml of OPA solution (4.28), 2 ml of borate buffer (4.29), 0,6 ml of 2-mercaptoethanol (4.33). Close, mix (5.30). Open and pour 0,4 ml of sample. Close, mix (5.30). **Inject immediately, as the derivative is not stable.** Rinse recipient immediately after injection, due to odour.

Note: Derivatisation can be carried out by an automatic changer-preparer. In this case, the process will be programmed to come close to the proportion of manual derivisation

6.4 Routine cleaning

Syringe (5.13) and needle (5.14) rinsed with demineralised water (4.1) after each sample;

filter holder (5.16) rinsed with hot water, then MeOH (4.6). Leave to drain and dry.

7. PROCEDURE

Mobile phase (5.31)

- A: phosphate buffer (4.2)

- B: acetonitrile (4.3)

Elution gradient:

time (in mins)	% A	% B
0	80	20
15	70	30
23	60	40
42	50	50
55	35	65
60	35	65
70	80	20
95	80	20

Note: The gradient can be adjusted to obtain a chromatogram close to the one presented in annex B

Flow rate: 1 ml/min;

Column temperature: 35 °C (5.32);

Detector (5.35): Exc = 356 nm, Em = 445 nm (5.30);

Internal calibration

The calibration solution is injected for each series;

Calibration by internal standard;

Calculation of response factors:

$$RF = C_{cis} \times \text{area } i / \text{area } is \times C_{ci}$$

C_{ci} = concentration of the component in the calibration solution and
C_{cis} = concentration of the internal standard in the calibration solution (1-6-diaminohexane).

Area i = area of the product peak present in the sample

Area is = area of the internal standard peak in the sample

Calculation of concentrations:

$$C_{ci} = (XF \times \text{area } i) / (\text{area } is \times RF)$$

Area i = area of the product peak present in the sample

Area is = area of the internal standard peak present in the sample

XF = quantity of internal calibration added to samples for analysis

XF = $119 \times 0.5/100 = 5.95$.

8. EXPRESSION OF RESULTS

Results are expressed in mg/l with one significant digit after the decimal point.

9. RELIABILITY

	r (mg/l)	R (mg/l)
Histamine	$0.07x + 0.23$	$0.50x + 0.36$
Methylamine	$0.11x + 0.09$	$0.40x + 0.25$
Ethylamine	$0.34x - 0.08$	$0.33x + 0.18$
Tyramine	$0.06x + 0.15$	$0.54x + 0.13$
Phenylethylamine	$0.06x + 0.09$	$0.34x + 0.03$
Diaminobutane	$0.03x + 0.71$	$0.31x + 0.23$
2-methylbutylamine et 3-methylbutylamine	$0.38x + 0.03$	$0.38x + 0.03$
Diaminopentane	$0.14x + 0.09$	$0.36x + 0.12$

The details of the interlaboratory trial with regard to reliability of the method are summarised in appendix A.

10. OTHER CHARACTERISTICS OF THE ANALYSIS

The influence of certain wine components: amino acids are released at the beginning of the analysis and do not impede in detection of biogenic amines.

The limit of detection (LOD) and limit of quantification (LOQ) according to an intralaboratory study

	LOD (in mg/l)	LOQ (in mg/l)
Histamine	0,01	0,03
Methylamine	0,01	0,02
Ethylamine	0,01	0,03
Tyramine	0,01	0,04
Phenylethylamine	0,02	0,06
Diaminobutane	0,02	0,06
2-methylbutylamine	0,01	0,03
3-methylbutylamine	0,03	0,10
Diaminopentane	0,01	0,03

11. QUALITY CONTROL

Quality controls may be carried out with certified reference materials, with wines the characteristics of which result from a consensus or spiked wines regularly inserted into analytical series and by following the corresponding control charts.

Annex A

Statistical data obtained from the results of interlaboratory trials
The following parameters were defined during an interlaboratory trial. This trial was carried out by the Oenology Institute of Bordeaux (France) under the supervision of the National Interprofessional Office of Wine (ONIVINS – France).

Year of interlaboratory trial: 1994

Number of laboratories: 7

Number of samples: 9 double blind samples

(Bulletin de l'O.I.V. November-December 1994, 765-766, p.916 to 962) numbers recalculated in compliance with ISO 5725-2:1994.

Types of samples: white wine (BT), white wine (BT) fortified = B1, white wine (BT) fortified = B2, red wine n°1 (RT), red wine fortified = R1, red wine (RT) fortified = R2, red wine n°2 (CT), red wine (CT) fortified = C1 and red wine (CT) fortified = C2. fortified in mg/l.

	HistN	MetN	EthN	TyrN	PhEtN	DiNbut	IsoamN	DiNpen
wine B1	wine BT + 0,5	wine BT + 0,12	wineBT + 0,13	wine BT + 0,36	wine BT + 0,15	wine BT + 0,5	wine BT + 0,28	wineBT + 0,25
wine B2	wine BT + 2	wine BT + 0,40	wine BT + 0,50	wine BT + 1,44	wine BT + 0,60	wine BT + 2	Wine BT + 0,1,74	wine BT + 1,04
wine C1	wine CT + 2	wine CT + 0,1	wine CT + 0,18	wine CT + 0,72	wine CT + 0,15	wine CT + 2	wine CT + 0,29	wine CT + 0,26
wineC2	wine CT + 4	wine CT + 0,41	wine CT + 0,50	wine CT + 2,90	wine CT + 0,58	wine CT + 8	wine CT + 1,14	wine CT + 1,04
wine R1	wine RT + 2	wine RT + 0,14	wine RT + 0,13	wine RT + 1,45	wine RT + 0,19	wine RT + 3	wine RT + 0,0,57	wine RT + 0,51
wine R2	wine RT + 5	wine RT + 0,41	wine RT + 0,50	wine RT + 2,88	wine RT + 0,59	wine RT + 10	wine RT + 2,28	wine RT + 2,08

HistN : histamine, MetN : methylamine, EthN : ethylamine, TyrN : tyramine,
 PhEtN : phenylethylamine, DiNbut : diaminobutane, IsoamN : isoamylamine and
 DiNpen : diaminopentane.

Annex B : Chromatogram model obtained by this method

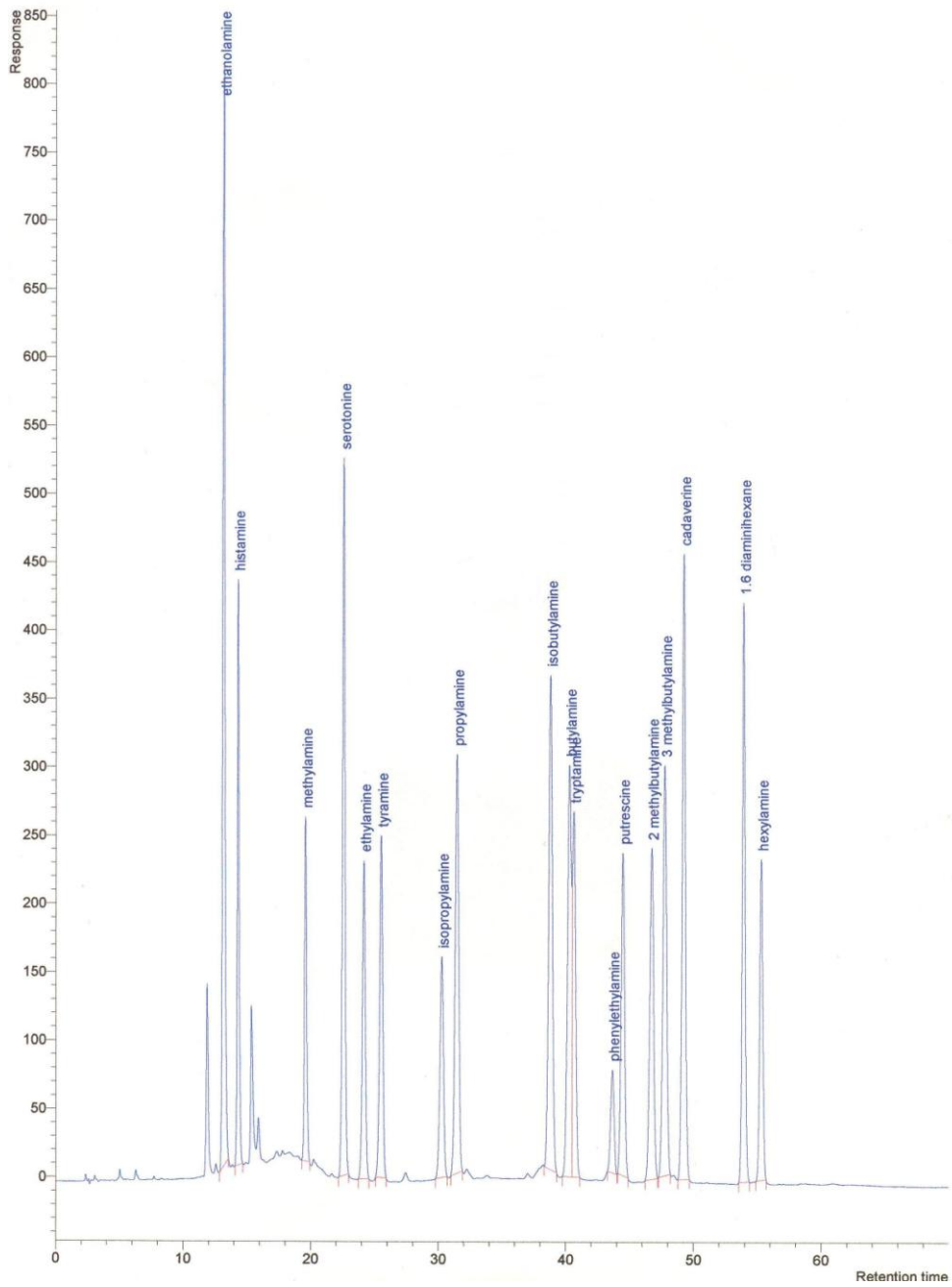

BIBLIOGRAPHY

TRICARD C., CAZABEIL J.-M., SALAGOÏTI M.H. (1991): Dosage des amines biogènes dans les vins par HPLC, *Analisis*, 19, M53-M55.

PEREIRA MONTEIRO M.-J. et BERTRAND A. (1994): validation d'une méthode de dosage – Application à l'analyse des amines biogènes du vin. *Bull. O.I.V.*, (765-766), 916-962.

Method OIV-MA-AS315-19

Type IV method

Determination of glutathione in musts and wines by capillary electrophoresis

(Resolution OIV-Oeno 345/2009)

1. Scope

This method makes it possible to determine the glutathione content of musts and wines in a concentration range of 0 to 40 mg/L. It uses capillary electrophoresis (CE) associated with fluorimetric detection (LIF).

2. Principle

The method used, which proceeds by capillary electrophoresis, is an adaptation of the method developed by Noctor and Foyer (1998) to determine non-volatile thiols in poplar leaves using HPLC coupled with fluorimetric detection.

The separation of a mixture's solutes by capillary electrophoresis is obtained by differential migration in an electrolyte. The capillary tube is filled with this electrolyte.

The sample to be separated is injected into one end of the capillary tube. As a result of electrical field activity generated by the electrodes immersed in the electrolyte, the solutes separate due to differences in migration speed and are detected near the other end of the capillary tube in the form of peaks. In given operating conditions, migration times constitute a criterion for the identification of chemical species and the peak area is proportional to the quantity injected.

3. Products and reagents

3.1 List of products

3.1.1 Glutathione (GSH, > 98 %)

3.1.2 Dithiothreitol (DTT, > 99 %)

3.1.3 Anhydrous monobasic sodium phosphate (NaH_2PO_4 , > 99 %)

3.1.4 Anhydrous dibasic sodium phosphate (Na_2HPO_4 , > 99 %)

3.1.5 2-(N-cyclohexylamino)ethanesulfonic acid (CHES, > 98 %),

3.1.6 Monobromobimane (MBB, 97 %)

3.1.7 Ethylenediamine tetraacetic acid sodium salt (EDTA, > 99 %)

3.1.8 Sodium hydroxide

3.1.9 Hydrochloric acid (35 %)

3.1.10 Acetonitrile (99.5 %)

3.1.11 Ultra-pure water with a resistance of >18 MΩ·cm.

3.2 List of solutions

All solutions are homogenised prior to use

3.2.1 Electrophoretic buffer: phosphate buffer, 50 mM, pH 7

This buffer is prepared using two solutions - A and B

3.2.1.1 Solution A: 3 mg of anhydrous monobasic phosphate (3.1.3) taken up by 250 ml ultra-pure water (3.1.11)

3.2.1.2 Solution B: 3.55 mg of anhydrous dibasic phosphate (3.1.4) taken up by 250 ml ultra-pure water (3.1.11)

The phosphate buffer is obtained by the addition of 40 ml of solution A (3.2.1.1) and 210 ml of solution B (3.2.1.2) and then made up to 500 ml with ultra-pure water (3.1.11). The buffer's pH is then adjusted to 7 using hydrochloric acid (3.1.9).

3.2.2 Monobromobimane solution (MBB) - 50 mM

25 mg of monobromobimane (MBB) (3.1.6) are taken up by 1,850 µl of acetonitrile (3.1.10).

Stored in the dark at -20 °C, this reagent remains stable for three months.

3.2.3 0.1 M sodium hydroxide solution

0.4 g of sodium hydroxide (3.1.8) are put into a 100-ml volumetric flask and taken up by 100 ml of ultra-pure water (3.1.11).

3.2.4 5 M sodium hydroxide solution

20 g of sodium hydroxide (3.1.8) are put into a 100-ml volumetric flask and taken up by 100 ml of ultra-pure water (3.1.11).

3.2.5 CHES buffer: 0.5 M, pH 9.3

2.58 g of 2-(N-cyclohexylamino) ethanesulfonic acid (CHES) (3.1.5) are dissolved in approximately 20ml of ultra pure water (3.1.11). The pH buffer is adjusted to 9.3 by the addition of sodium hydroxide 5 M (3.2.4). The volume is then adjusted to 25 ml with ultra pure water (3.1.11). This buffer is divided between the 1.5-ml test tubes (Eppendorf type) with 1 ml per tube. Stored at -20 °C, the CHES aqueous solution may be kept for several months.

3.2.6 Dithiothreitol solution (DTT) - 10 mM

15.4 mg of dithiothreitol (3.1.2) is dissolved in 10 mL of ultra pure water (3.1.11) then this solution is divided in 1.5-ml test tube (Eppendorf type) with 1 ml per tube. Stored at -20 °C, this DTT aqueous solution may be kept several months.

4. Apparatus

4.1 Capillary electrophoresis

Capillary electrophoresis equipped with a hydrostatic-type injector is coupled with a laser-induced fluorescence detector with an excitation wavelength similar to the absorption wavelength of the MBB-GSH adduct: e.g.= 390 nm (e.g. Zetalif detector).

4.2 The capillary tube

The total length of the non-grafted silica capillary tube is 120 cm. Its effective length is 105 cm, and its internal diameter is 30 µm.

5. Preparation of samples

The method of determination used consists of the derivatization of the SH functions by the monobromobimane (MBB) (Radkowsky & Kosower, 1986). Samples of musts or non-bottled wines are clarified by centrifugation prior to analysis. Bottled wines are analysed without prior clarification.

Preparation of samples:

In a 1.5-ml test tube (Eppendorf type), put successively:

- 200 µl of the sample,
- 10 µl of the DTT solution (3.2.4) - final concentration of 0.25 mM,
- 145 µl of CHES (3.2.3) - final concentration of 179 mM,
- 50 µl of MBB (3.2.2) - final concentration of 6.2 mM.

After stirring the reagent mixture, the derivatization of thiol functions by the MBB requires a 20-minute incubation period in the dark at ambient temperature. In these analytical conditions, the MBB-SR derivatives thus formed are relatively unstable; CE-LIF determination should be carried out immediately after incubation.

6. Procedure

6.1 Capillary tube preparation

Before being used for the first time and as soon as migration times increase, the capillary tube (4.2) should be treated in the following way:

- 6.1.1. Rinse with 0.1 M sodium hydroxide (3.2.5) for 3 minutes,
- 6.1.2. Rinse with ultra-pure water (3.1.12) for 3 minutes,
- 6.1.3. Rinse with the electrophoretic phosphate buffer (3.2.1) for 3 minutes.

6.2 Migration conditions

6.2.1 Injection of the sample is of the hydrostatic type; 3 s at 50 kPa.

This is followed by injection of 50 mb electrophoretic buffer (3.2.1) to improve peak resolution (Staking).

6.2.2 Analysis.

A voltage of +30 kV, applied throughout separation, generates a current of 47 μ A. These conditions are reached in 20 s. Separation is carried out at a constant temperature of 21 °C.

6.2.3 Rinsing the capillary tube

The capillary tube should be rinsed after each analysis, successively with:

- 0.1M sodium hydroxide (3.2.5) for 3 minutes,
- ultra-pure water (3.1.12) for 3 minutes,
- electrophoretic phosphate buffer (3.2.1) for 3 minutes.

7. Results

At the concentration ultimately used in the sample, the presence of DTT during derivatization makes it possible to stabilise the unstable functions of thiols that have an alkaline pH and are very easily oxidized by quinines produced by phenolic compound auto-oxidation, but does not break the disulphide bonds. Thus, under these analytical conditions, the reduced glutathione content (GSH) found in a wine with or without the addition of 10 mg/l of oxidized glutathione (GSSG) is strictly comparable (Figure 1). This method therefore makes it possible to determine glutathione content in its reduced form alone.

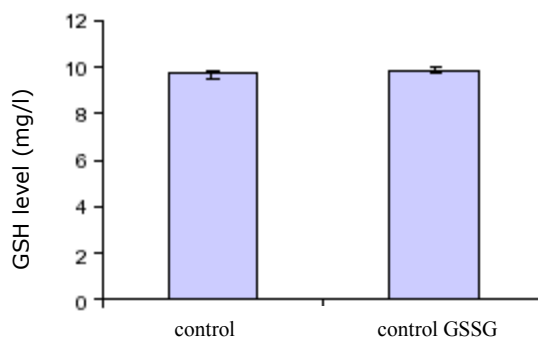

Figure 1: Demonstration of the stability of disulphide bonds according to the conditions of derivatization described. (DTT, ultimately 0.25 mM).

Figure 2 shows the electrophoretic profile of a white grape must sample (Sauvignon) in which cysteine, glutathione, N-acetyl-cysteine and sulphur dioxide are identified. The first peak corresponds to excess reagents (DTT, MBB). The separation of non-volatile thiols takes less than 20 minutes. Only certain peaks could be identified (Figure 2, A) (Newton et al., 1981). These thiols, apart from the sulphur dioxide, are generally present in varying quantities in grapes (Cheynier et al., 1989), fruit and vegetables (Mills et al., 2000).

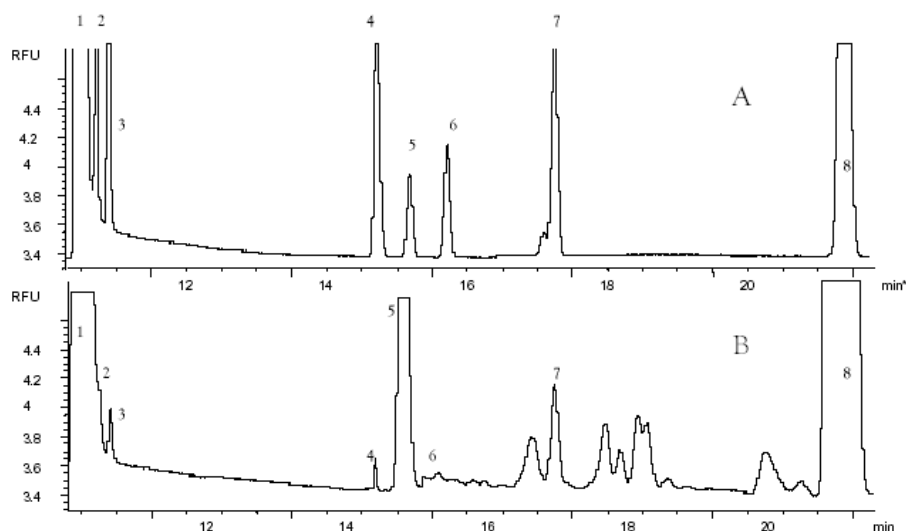

Figure 2: Example of the separation of the known non-volatile thiols in an HCl/EDTA solution (A) 1 and in a grape must (B): DTT; 2: homocysteine; 3: cysteine; 4: Cys-Gly; 5: GSH; 6: g Glu-Cys; ,7: NAC; 8: SO₂ .

In these analytical conditions, MBB-RS adduct retention times are as follows: MBB-homocysteine 10.40 mins; MBB-cysteine 10.65 mins, MBB-GSH 14.14 mins; MBB-NAC 15.41mins; MBB-SO₂ 18.58mins.

8. Characteristics of the method

Certain internal elements of validation were determined, but do not constitute formal validation according to the protocol for the design, conducts and interpretation of methods of analysis performance studies (OIV 6/2000).

COMPENDIUM OF INTERNATIONAL METHODS OF ANALYSIS-OIV
Glutathione

Wine is used as a matrix to produce calibration curves and repeatability tests for each compound. Each concentration is calculated based on the average of three determinations obtained by using the right of the calibration curb regression. Results are expressed in mg/L.

Linear regressions and correlation coefficients are calculated according to the least squares method. The stock solutions of the various thiols are produced from an HCl/EDTA solution, allowing them to be stored at +6 °C for several days with no loss. Successive dilutions of these solutions allow the threshold limits for detection in wine to be estimated, for a signal-to-noise ratio of three or more.

The linearity spectrum varies according to thiols (Table 1).

Table 1: Linearity spectrum, linear regression properties for each thiol in solutions prepared in exactly the same way as that of the glutathione.

	Linearity spectrum	Linear regression	Correlation coefficient
Homocysteine	0 - 15 mg/l	$Y = 0.459X - 0.231$	0.9987
Cysteine	0 - 15 mg/l	$Y = 0.374X - 0.131$	0.9979
Glutathione	0 - 40 mg/l	$Y = 0.583X - 0.948$	0.9966
N-acetyl-cysteine	0 - 10 mg/l	$Y = 0.256X - 0.085$	0.9982

These analytical conditions make it possible to eliminate interference caused by MBB hydrolysis products, unlike the reported findings of other works (Ivanov et al., 2000).

The method's repeatability is calculated on the basis of ten analyses of the same sample of wine. For a thiol concentration of 10 mg/l, the coefficient of variation is 6.0 % for the glutathione; besides this, it is 3.2 % for the homocysteine, 4.8 % for the cysteine and 6.4 % for the N-acetyl-cysteine.

The limit for detecting glutathione is 20 µg/l and the quantification limit is 60 µg/l.

9. Bibliography

- Noctor, G. and C. Foyer, 1998. Simultaneous measurement of foliar glutathione, gamma-glutamylcysteine, and amino acids by high-performance liquid chromatography: comparison with two other assay methods for glutathione, *Analytical Biochemistry*, **264**, 98-110.
- Kosower, N.S., Kosower E. M., Newton G. L., and Ranney H. M., 1979. Bimane fluorescent labels: Labeling of normal human red cells under physiological conditions. *Proc. Natl. Acad. Sci.*, **76** (7), 3382-3386.
- Newton, G.L., R. Dorian, and R.C. Fahey, *Analysis of biological thiols: derivatisation with monobromobimane and separation by reverse-phase high-performance liquid chromatography*. *Anal. Biochem.*, 1981. **114**: p. 383-387.
- Cheyrier, V., J.M. Souquet, and M. Moutounet, 1989. Glutathione content and glutathione to hydroxycinnamic acid ratio in *Vitis vinifera* grapes and musts. *Am. J. Enol. Vitic.*, **40** (4), 320-324.
- Mills, B.J., Stinson C. T., Liu M. C. and Lang C. A., 1997. Glutathione and cyst(e)ine profiles of vegetables using high performance liquid chromatography with dual electrochemical detection. *Journal of food composition and analysis*, **10**, 90-101.
- Ivanov, A.R., I.V. Nazimov, and L. Baratova, 2000. Determination of biologically active low molecular mass thiols in human blood. *Journal of Chromatogr. A.*, **895**, 167-171.

**COMPENDIUM OF INTERNATIONAL ANALYSIS OF
METHODS – OIV
 α -dicarbonyl compounds by HPLC after derivatization**

**METHOD FOR THE DETERMINATION OF α -DICARBONYL
COMPOUNDS OF WINE by HPLC AFTER DERIVATIZATION BY 1,2-
DIAMINOBENZENE
(OIV-Oeno 386A-2010)**

Method OIV-MA-AS315-20

Type IV method

1. Introduction

The principal α -dicarbonyl compounds found in wine (Fig 1) are: glyoxal, methylglyoxal, diacetyl and pentane-2,3-dione, but only α -diketones are relatively abundant in wine. Carbonyl compounds exist in all types of wines, particularly after malolactic fermentation and in red wines. In addition, sweet white wines produced with botrytized grapes can contain high levels of glyoxal and methylglyoxal.

Glyoxal: $\text{OCH}-\text{CHO}$ (ethanedial)

Methylglyoxal: $\text{CH}_3-\text{CO}-\text{CHO}$ (2-oxopropanal)

Diacetyl: $\text{CH}_3-\text{CO}-\text{CO}-\text{CH}_3$ (2,3-butanedione)

2,3-Pentanedione: $\text{CH}_3-\text{CH}_2-\text{CO}-\text{CO}-\text{CH}_3$

2,3-Hexanedione: $\text{CH}_3-\text{CH}_2-\text{CH}_2-\text{CO}-\text{CO}-\text{CH}_3$

Figure 1. The principal α -dicarbonyl compounds of wine (2,3-hexanedione is not naturally present in wine but it is used as internal standard).

Dicarbonyl compounds are important in wine for different reasons: their sensory impact, the reactivity with other components of the wine or possible microbiological effects.

**COMPENDIUM OF INTERNATIONAL ANALYSIS OF
METHODS – OIV
 α -dicarbonyl compounds by HPLC after derivatization**

2. Applicability

This method applies to all types of wines (white, red, sweetened or fortified), for dicarbonyl compounds with a content that ranges from 0.05 mg/l to 20 mg/l .

3. Principle

The method is based on the formation of derivatives of the quinoxaline type based on the α -dicarbonyl compounds of the wine with 1,2-diaminobenzene (Figure 2).

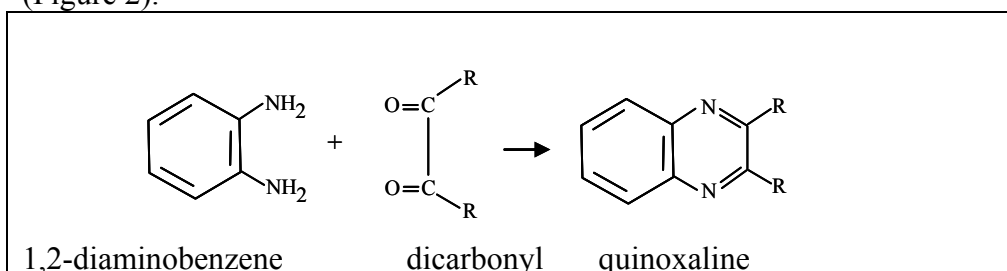

Figure 2 Formation of derivatives.

The reaction takes place directly in the wine at pH 8 and after a reaction time of 3 h at 60°C. The analysis of the derivatives is then carried out directly by high-performance liquid chromatography (HPLC) and detection by UV absorption at 313 nm.

4. Reagents and products

4.1 Dicarbonyl compounds

- 4.1.1 Glyoxal in a solution at 40% (CAS N° 107-22-3)
- 4.1.2 Methylglyoxal in a solution at 40% (CAS N° 78-98-8)
- 4.1.3 Diacetyl, purity > 99% (CAS N° 431-03-8)
- 4.1.4 2,3-Pentanedione, purity > 97% (CAS N° 600-14-6)
- 4.1.5 2,3-Hexanedione, purity > 90% (CAS N° 3848-24-6)

**COMPENDIUM OF INTERNATIONAL ANALYSIS OF
METHODS – OIV
 α -dicarbonyl compounds by HPLC after derivatization**

- 4.2 1,2-Diaminobenzene in powder form, purity > 97%
- 4.3 Water for HPLC (for example microfiltered and with a resistivity of 18.2 M Ω) (CAS N° 95-54-5)
- 4.4 Pure ethanol for HPLC (CAS N° 64-17-5)
- 4.5 Sodium Hydroxide M (CAS N° 1310-73-2)
- 4.6 Pure crystallisable acetic acid (CAS N° 64-19-7)
- 4.7 Solvent A for the analysis by HPLC
To 1 l of water for HPLC (4.3) add 0.5 ml of acetic acid (4.8), mix, degas (for example by sonication)
- 4.8 Solvent B for HPLC
Pure methanol for HPLC (CAS N° 67-56-1)
- 4.9 Aqueous-alcoholic solution at 50% vol.
Mix 50 ml of pure ethanol for HPLC (4.4) with 50 ml of water (4.3)
- 4.10 Solution of internal standard 2,3-hexanedione at 2.0 g/l
Place 40 mg of 2,3-hexanedione (4.2) in a 30-ml flask, dilute in 20 ml of aqueous-alcoholic solution to 50% vol (4.9) and stir until it has completely dissolved.

5. Equipment

- 5.1 High-performance liquid chromatograph with detection by UV absorption (313 nm);
- 5.1.1 Analytical column filled with 5 μ m octadecyl silica whose dimensions are for example 250 mm x 4.6 mm.
- 5.1.2 Data acquisition system.
- 5.2 pH measuring apparatus.
- 5.3 Magnetic stirrer.
- 5.4 Balance with a precision of 0.1 mg.
- 5.5 Solvent degasification system for HPLC (for example an ultrasonic bath).
- 5.6 Oven which can be set to 60°C.
- 5.7 Standard laboratory glassware including pipettes, 30-ml screw-cap flasks, and microsyringes.

**COMPENDIUM OF INTERNATIONAL ANALYSIS OF
METHODS – OIV
 α -dicarbonyl compounds by HPLC after derivatization**

6. Preparation of the sample

No specific preparation is necessary.

7. Procedure

Place 10 ml of wine in a 30-ml flask (5.7)

Bring to pH 8 while stirring, with sodium hydroxide M (4.5)

Add 5 mg of 1,2-diaminobenzene (4.2)

Add 10 μ l of 2,3-hexanedione (internal standard) at 2.0 g/L (4.10)

Close the flask using a screw-cap fitted with a Teflon-faced seal

Stir until the reagent has completely disappeared (5.3)

Place in the oven at 60°C for 3 h (5.6)

Cool.

7.1 Optimisation and analytical conditions

The yield of the reaction of the dicarbonyl compounds with the 1-2-diaminobenzene is optimal at pH 8. Solutions of dicarbonyl compounds have been derivatized at 25, 40 or 60°C and then analysed by HPLC according to the protocol described in point 7.2 at different times (Table 1). Diketones require much more reaction time and a higher reaction temperature. The reaction is slower with molecules with longer chains (2,3-pentanedione and 2,3-hexanedione).

In addition, no interference of SO₂ with the formation of quinoxalines was noted during the study of the method.

**COMPENDIUM OF INTERNATIONAL ANALYSIS OF
METHODS – OIV
 α -dicarbonyl compounds by HPLC after derivatization**

Table 1. Effect of reaction time and temperature on the formation of derivatives by diamminobenzene from glyoxal, diacetyl and 2,3-hexanedione

	Temperature (°C)	Reaction time		
		1h	2h	3h
Glyoxal	25	92	93	94
	40	95	97	98
	60	96	98	100
Diacetyl	25	23	77	87
	40	64	89	94
	60	85	100	100
2,3-Hexanedione	25	17	67	79
	40	55	79	88
	60	69	93	100

7.2 Analysis by HPLC

- *Injection.* After cooling, 20 μ l of the reaction medium containing the quinoxalines is directly injected into the HPLC system.
- *Elution programme.* For the separation, the elution programme is presented in Table 2

Table 2. Elution programme for the analysis by HPLC

Time in minutes	solvent A	solvent B
0	80	20
8	50	50
26	25	75
30	0	100
32	0	100
40	100	0
45	80	20
50	80	20

**COMPENDIUM OF INTERNATIONAL ANALYSIS OF
METHODS – OIV
 α -dicarbonyl compounds by HPLC after derivatization**

The flow rate is 0.6 ml/min

- *Separation.* The chromatogram obtained by HPLC is shown in Figure 3.
- *Detection.* The maximum absorbance was studied for all the derivatized dicarbonyl compounds and set at 313 nm as being optimal.
- *Identification of derivatives.* The identification of the derivatives was carried out by comparing the retention times with standard reference solutions. The chromatographic conditions permit a good separation of the peaks in all wines.

7. 2.1 Characteristics of the method by HPLC

Some internal validation methods have been determined but do not constitute a formal validation process according to the protocol governing the planning, the implementing and the interpreting of performance studies pertaining to analysis methods (OIV 6/2000)

- *Repeatability.* The repeatability of the method was calculated using 10 analyses of the same wine (Table 3).

Table 3. Repeatability study and performance of the method

	Average*	Standard deviation	CV (%)
<u>White wine</u>			
Glyoxal	4.379	0.101	2.31
Methylglyoxal	2.619	0.089	3.43
Diacetyl	5.014	0.181	3.62
2,3-Pentanedione	2.307	0.097	4.21
<u>Red wine</u>			
Glyoxal	2.211	0.227	10.30
Methylglyoxal	1.034	0.102	9.91
Diacetyl	1.854	0.046	2.49
2,3-Pentanedione	0.698	0.091	13.09

* Results in mg/l based on 10 analyses of the same wine.

**COMPENDIUM OF INTERNATIONAL ANALYSIS OF
METHODS – OIV
 α -dicarbonyl compounds by HPLC after derivatization**

- *Linearity.* The linearity of the method was tested using standard solutions (using an aqueous-alcoholic solution at 12% vol. as a matrix) (Table 4). The quantitative analysis of the additions of dicarbonyl compounds showed that the method is linear for the four compounds and that its precision is satisfactory.

Table 4. Study of the linearity and recovery tests with standard solutions (water-ethanol at 12% v/v) Value of the correlation coefficient

Glyoxal value ^a peak area ^b	Methylglyoxal value ^a peak area ^b	Diacetyl value ^a peak area ^b	Pentane-2,3-dione value ^a peak area ^b
1			
R = 0.992	R = 0.997	R = 0.999	R = 0.999

- *The recovery* of additions carried out in red and white wines demonstrated the satisfactory performance of the method . Contained in the 92% - 116% range for extreme values

- *The quantification limit* of the dicarbonyl compounds is very low, the best results being obtained with diacetyl, whose detection limit is 10 times lower than that of the other compounds (Table 5).

Table 5. Performance of the method by HPLC for the quantification of dicarbonyl compounds

Limits	detection ^a	determination ^a	quantification ^a
Glyoxal	0.015	0.020	0.028
Methylglyoxal	0.015	0.020	0.027
Diacetyl	0.002	0.002	0.003
2.3-Pentanedione	0.003	0.004	0.006

a: results in mg/l, aqueous-alcoholic solution (10% vol).

**COMPENDIUM OF INTERNATIONAL ANALYSIS OF
METHODS – OIV
 α -dicarbonyl compounds by HPLC after derivatization**

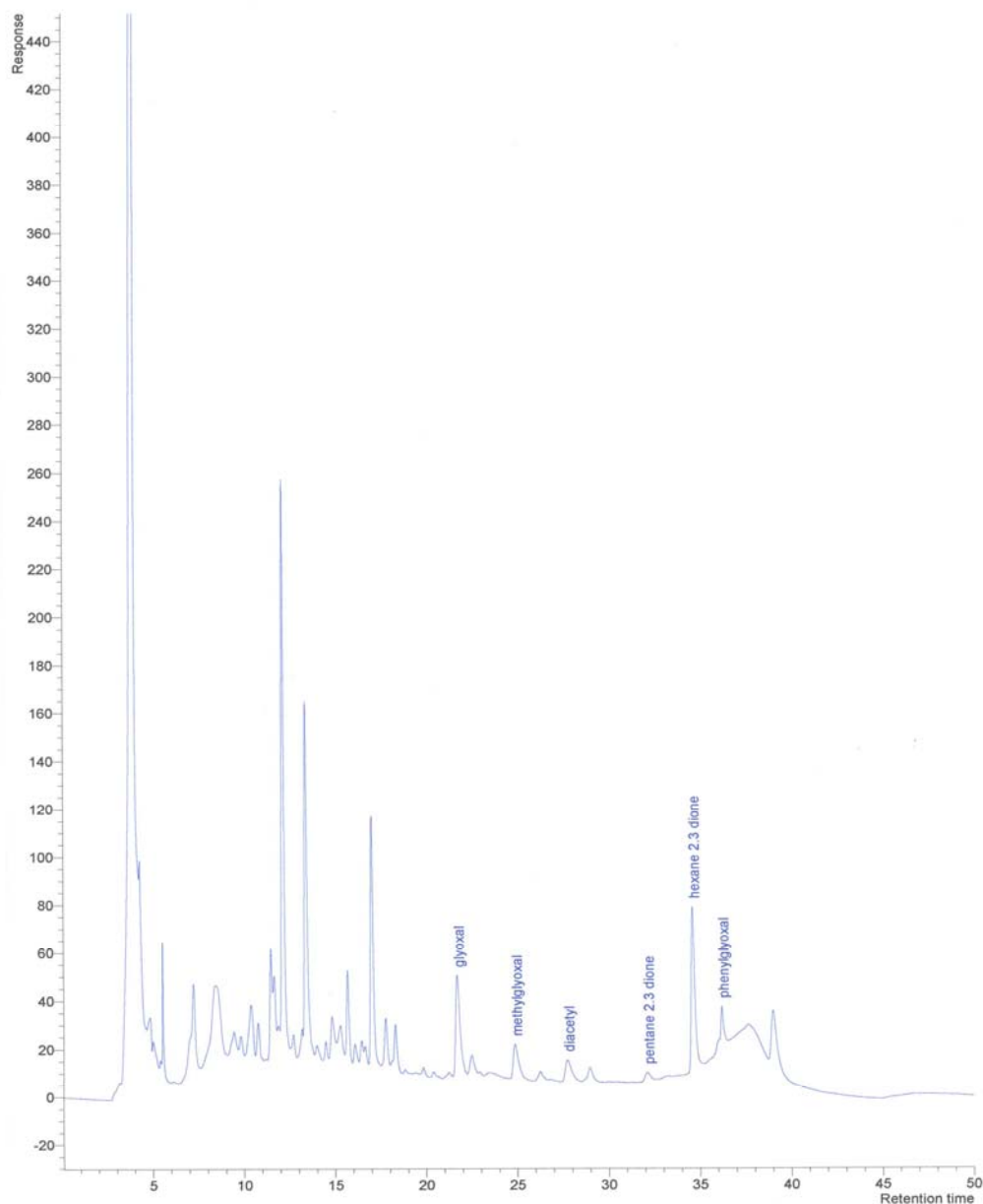

Figure 3. High-performance liquid phase chromatogram of dicarbonyl compounds derivatized by 1,2-diaminobenzene from a white wine, detected by UV at 313 nm. Spherisorb ODS Column 250 mm x 4.6 mm x 5 μ m.

**COMPENDIUM OF INTERNATIONAL ANALYSIS OF
METHODS – OIV
 α -dicarbonyl compounds by HPLC after derivatization**

Bibliography

Bartowski E.J. and Henschke P.A., The buttery attribute of wine – diacetyl – desirability spoilage and beyond. *Int. J. Food Microbiol.* 96: 235-252 (2004).

Bednarski W., Jedrychowski L., Hammond E., and Nikolov L., A method for determination of α -dicarbonyl compounds. *J. Dairy Sci.* 72:2474-2477 (1989).

Leppanen O., Ronkainen P., Koivisto T. and Denslow J., A semiautomatic method for the gas chromatographic determination of vicinal diketones in alcoholic beverages. *J. Inst. Brew.* 85:278- 281 (1979).

Martineau B., Acree T. and Henick-Kling T., Effect of wine type on the detection threshold for diacetyl. *Food Res. Int.* 28:139-143 (1995).

Moree-Testa P. and Saint-Jalm Y., Determination of α -dicarbonyl compounds in cigarette smoke. *J. Chromatogr.* 217:197-208 (1981).

De Revel G., Pripis-Nicolau L., Barbe J.-C. and Bertrand A., The detection of α -dicarbonyl compounds in wine by the formation of quinoxaline derivatives. *J. Sci. Food Agric.* 80:102-108 (2000).

De Revel G. and Bertrand A., Dicarbonyl compounds and their reduction products in wine. Identification of wine aldehydes. *Proc. 7th Weurman Flavour Research Symp, Zeist, June, pp 353-361 (1994).*

De Revel G. and Bertrand A., A method for the detection of carbonyl compounds in wine: glyoxal and methylglyoxal. *J. Sci. Food Agric.* 61:267-272 (1993).

Voulgaropoulos A., Soilis T. and Andricopoulos N., Fluorimetric determination of diacetyl in wines after condensation with 3,4-diaminoanisole. *Am. J. Enol. Vitic.* 42:73-75 (1991).

Gilles de Revel et Alain Bertrand Analyse des composés α -dicarbonyles du vin après dérivation par le 2,3-diaminobenzène OIV FV 1275

**COMPENDIUM OF INTERNATIONAL ANALYSIS OF
METHODS – OIV
 α -dicarbonyl compounds by GC after derivatization**

**METHOD FOR THE DETERMINATION OF α -
DICARBONYL COMPOUNDS OF WINE BY GC AFTER
DERIVATIZATION BY 1,2-DIAMINOBENZENE
(OIV-Oeno 386B-2010)**

Method OIV-MA-AS315-21

Type IV method

1. Introduction

The principal α -dicarbonyl compounds found in wine (Fig 1) are: glyoxal, methylglyoxal, diacetyl and 2,3-pentanedione, but only α -diketones are relatively abundant in wine. Carbonyl compounds exist in all types of wines, particularly after malolactic fermentation and in red wines. In addition, sweet white wines produced with botrytized grapes can contain high levels of glyoxal and methylglyoxal.

Glyoxal: OCH-CHO (ethanedial)

Methylglyoxal: $\text{CH}_3\text{-CO-CHO}$ (2-oxopropanal)

Diacetyl: $\text{CH}_3\text{-CO-CO-CH}_3$ (2,3-butanedione)

2,3-pentanedione: $\text{CH}_3\text{-CH}_2\text{-CO-CO-CH}_3$

2,3-hexanedione: $\text{CH}_3\text{-CH}_2\text{-CH}_2\text{-CO-CO-CH}_3$

Figure 1. The principal α -dicarbonyl compounds of wine (2,3-hexanedione is not naturally present in wine but it is used as internal standard).

COMPENDIUM OF INTERNATIONAL ANALYSIS OF METHODS – OIV

α -dicarbonyl compounds by GC after derivatization

Dicarbonyl compounds are important in wine for different reasons: their sensory impact, the reactivity with other components of the wine or possible microbiological effects.

2. Applicability

This method applies to all types of wines (white, red, sweetened or fortified), for carbonyl derivatives content ranging from 0.05 mg/L and 20 mg/L.

3. Principle

The method is based on the formation of derivatives of the quinoxaline type based on the α -dicarbonyl compounds of the wine with 1,2-diaminobenzene (Figure 2).

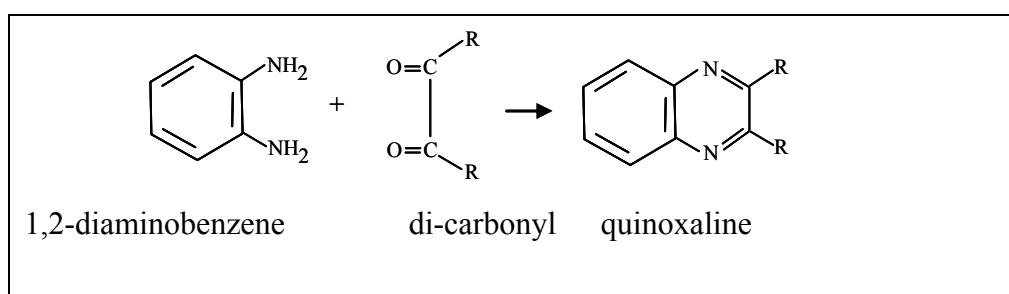

Figure 2 Formation of derivatives.

The reaction takes place directly in the wine at pH 8 and after a reaction time of 3 h at 60°C. The analysis of the derivatives is then carried out after extraction of the derivatives by dichloromethane and analysis by gas chromatography with detection by mass spectrometry (GC-MS) or using a nitrogen-specific detector.

4. Reagents and products

4.1 Dicarbonyl compounds

4.1.1 Glyoxal in a solution at 40% (CAS n° 107-22-3)

4.1.2 Methylglyoxal in a solution at 40% (CAS n° 78-98-8)

4.1.3 Diacetyl, purity > 99% (CAS n° 431-03-8)

4.1.4 2,3-Pentanedione, purity > 97% (CAS n° 600-14-6)

4.1.5 2,3-Hexanedione, purity > 90% (CAS n° 3848-24-6)

4.2 1,2-Diaminobenzene in powder form, purity > 97% (CAS n° 95-54-5)

**COMPENDIUM OF INTERNATIONAL ANALYSIS OF
METHODS – OIV
 α -dicarbonyl compounds by GC after derivatization**

4.3 Water for HPLC (for example microfiltered and with a resistivity of 18.2

M Ω)

4.4 Pure ethanol for HPLC (CAS n° 64-17-5)

4.5 Sodium hydroxide M. (CAS n° 1310-73-2)

4.6 Sulphuric acid 2M (CAS n° 7664-93-9)

4.7 Dichloromethane (CAS n° 75-09-2)

4.8 Anhydrous sodium sulphate (CAS n° 7757-82-6)

4.9 Aqueous-alcoholic solution at 50% vol .

Mix 50 ml of pure ethanol for HPLC (4.4) with 50 ml of water (4.3)

4.10 Solution of internal standard 2,3-hexanedione at 2.0 g/L

Place 40 mg of 2,3-hexanedione (4.2) in a 30-ml flask, dilute in 20 ml of aqueous-alcoholic solution to 50% vol (4.9) and stir until it has completely dissolved.

4.11 Anhydrous sodium sulphate (CAS n° 7757-82-6)

5. Equipment

5.1 Gas chromatograph with detection by mass spectrometry (GC-MS) or a nitrogen-specific detector.

5.1.1 Relatively polar, polyethylene glycol capillary column (CW 20M, BP21 etc.) with the following characteristics (as an example): 50 m x 0.32 mm x 0.25 μ m.

5.1.2 Data acquisition system.

5.2 pH measuring apparatus

5.3 Magnetic stirrer

5.4 Balance with a precision of 0.1 mg.

5.5 Oven which can be set to 60°C

5.6 Standard laboratory glassware including pipettes, screw-cap flasks, and microsyringes.

6. Preparation of the sample

No specific preparation is necessary

7. Procedure

Place 50 ml of wine in a flask (5.6)

**COMPENDIUM OF INTERNATIONAL ANALYSIS OF
METHODS – OIV
 α -dicarbonyl compounds by GC after derivatization**

Bring to pH 8 while stirring, with sodium hydroxide M (4.5)

Add 25 mg of 1,2-diaminobenzene (4.2)

Add 50 μ l of 2,3-hexanedione (internal standard) at 2.0 g/L (4.10)

Close the flask using a screw-cap fitted with a Teflon-faced seal

Stir until the reagent has completely disappeared (5.3)

Place in the oven at 60°C for 3 h (5.5)

Cool.

7.1 Optimisation and analytical conditions (this study was carried out by HPLC analysis, see this method)

The yield of the formation of derivatives of the dicarbonyl compounds with the 1-2-diaminobenzene is optimal at pH 8 at 60°C after three hours of reaction time

In addition, no interference of SO₂ with the formation of quinoxalines was noted during the study of the method.

7.2 Analysis by GC

7.2.1 Extraction of quinoxalines

- The reaction medium prepared in 7 is brought to pH 2 using H₂SO₄ 2M (4.6);

- Extract 2 times using 5 ml of dichloromethane (4.7) by magnetic stirring for 5 minutes;

- Decant the lower phase each time;

- Mix the two solvent phases;

- Dry on approximately 1 g of anhydrous sodium sulphate (4.11);

- Decant.

7.2.2 Chromatographic analysis (given as an example)

- *Detection.* For the analysis by GC-MS, a Hewlett Packard HP 5890 gas-phase chromatograph was coupled with Chemstation software and an HP 5970 mass spectrometer (electronic impact 70eV, 2.7 kV),

Note: It is also possible to use a nitrogen-specific detector

- *Column.* The column is a BP21 (SGE, 50 m x 0.32 mm x 0.25 μ m).

- *Temperatures.* The temperature of the injector and the detector are respectively 250°C and 280°C; that of the oven is held at 60°C for 1min,

**COMPENDIUM OF INTERNATIONAL ANALYSIS OF
METHODS – OIV
 α -dicarbonyl compounds by GC after derivatization**

then programmed to increase at a rate of 2°C/min to 220°C and the final isothermal period lasts 20 min.

- *Injection.* The volume injected is 2 μ l and the splitless time of the injector valves is 30s.

7.2.3 Analysis of quinoxalines formed

- *Separation.* The chromatogram of the derivatives from a wine obtained with 1,2-diaminobenzene, using selected-ion monitoring (SIM), is shown in Figure 3. Good separations were obtained with all types of wines (white, red, sweetened or fortified), and even with fermenting musts.

- *Identification of the peaks.* GC-MS was used to identify the dicarbonyl compounds derivatized from the wine based on the total ion current method (scan) which is used to obtain the mass spectra of derivatized quinoxalines and to compare them with those recorded in the library; in addition, the retention times were compared with those for pure compounds treated in the same way. Table 1 shows the principal ions of the mass spectra for the derivatized dicarbonyl compounds obtained.

- *Determination.* The quantitative determination of the dicarbonyl compounds is performed with the SIM method, by selecting ions $m/z = 76, 77, 103, 117, 130, 144, 158$ and 171 . The ions $m/z = 76$ and 77 are used for the quantification and the others as qualifiers, i.e. glyoxal: ions $m/z = 103$ and 130 , methylglyoxal: ions $m/z = 117$ and 144 , diacetyl: ions $m/z = 117$ and 158 , 2,3-pentandione: ions $m/z = 171$ and 2,3-hexanedione: ions $m/z = 158$ and 171 .

7.2.4 Characteristics of the method

Some elements of internal validation were determined, but this is not a formal validation according to the protocol governing the planning, the implementing and the interpreting of the performance studies pertaining to the analysis methods (OIV 6/2000)

- *Repeatability.* The repeatability of the GC-MS-SIM method shows coefficients of variation ranging between 2 and 5% for the four dicarbonyl compounds;

- *Recovery rate.* The quantities added to a wine were recovered with a recovery rate ranging between 92 and 117%;

**COMPENDIUM OF INTERNATIONAL ANALYSIS OF
METHODS – OIV
 α -dicarbonyl compounds by GC after derivatization**

- *Linearity*. Linear correlations were obtained in concentrations ranging from 0.05 to 20 mg/l.
- *Limit of detection*. The limit of detection of most of the derivatized dicarbonyl compounds using wine as a matrix is 0.05 mg/l

Table 1. Mass spectra (ion m/z and abundance of the ion in relation to that of the base peak) of derivatives of dicarbonyl compounds using 1,2-diaminobenzene

Dicarbonyl compound	Derivative	Mass spectrum (principal ions and abundance)
Glyoxal	Quinoxaline	130 (100), 103 (56.2), 76 (46.8), 50 (20.2), 75 (10.4), 131 (9.4)
Methylglyoxal	2-Methylquinoxaline	144 (100), 117 (77.8), 76 (40.5), 77 (23.3), 50 (21.9), 75 (11.3), 145 (10.3)
Diacetyl	2,3-Dimethylquinoxaline	117 (100), 158 (75.6), 76 (32.3), 77 (23.1), 50 (18.3), 75 (10.4)
2,3-Pentanedione	2-Ethyl-3-methylquinoxaline	171 (100), 172 (98), 130 (34.1), 75 (33.3), 77 (21), 50 (19.4), 144 (19), 143 (14.1), 103 (14)
2,3-Hexanedione	2,3-Diethylquinoxaline	158 (100), 171 (20.1), 76 (13.7), 77 (12.8),

**COMPENDIUM OF INTERNATIONAL ANALYSIS OF
METHODS – OIV
 α -dicarbonyl compounds by GC after derivatization**

159 (11.4), 157 (10.8),
50 (8.1)

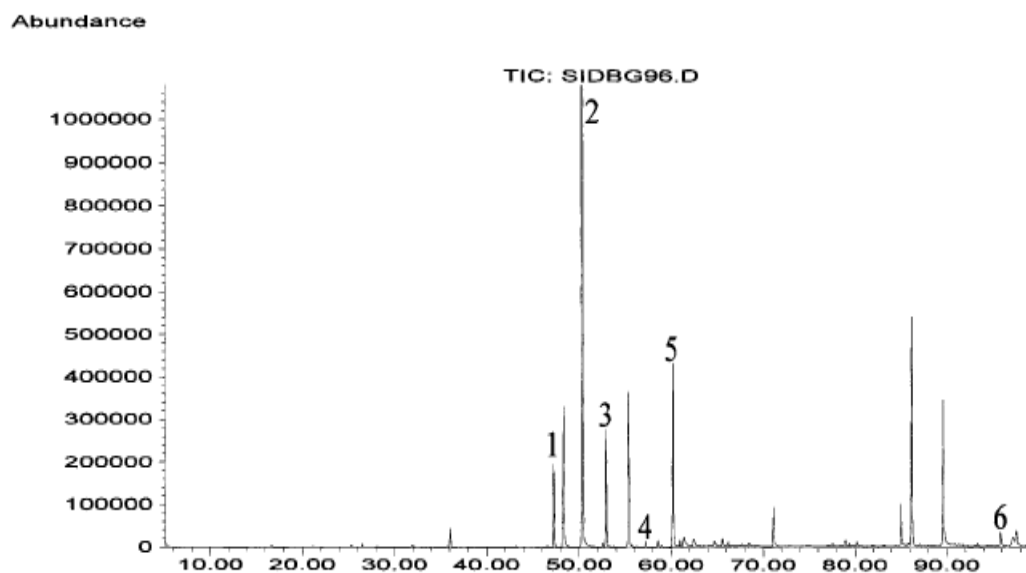

Figure 3. Gas chromatogram of the extract from the dicarbonyl compounds derivatized by 1,2-diaminobenzene from a white wine, detected by mass spectrometry by selecting the ions $m/z = 76, 77, 103, 117, 130, 131, 144, 158, 160$ and 171. BP21 Column, 50m x 0.32mm x 0.25 μm oven temperature 60°C for 1min, then programmed increase of 2°C/min up to 220°C. Injector temperature: 250°C.

1. glyoxal; 2. methylglyoxal; 3. diacetyl; 4. 2,3-pentanedione; 5. 2,3-hexanedione (internal standard); 6. phenylglyoxal (not studied with this method).

**COMPENDIUM OF INTERNATIONAL ANALYSIS OF
METHODS – OIV
 α -dicarbonyl compounds by GC after derivatization**

Bibliography

Bartowski E.J. and Henschke P.A. The buttery attribute of wine – diacetyl – desirability spoilage and beyond. *Int. J. Food Microbiol.* 96: 235-252 (2004).

Bednarski W., Jedrychowski L., Hammond E., and Nikolov L., A method for determination of α -dicarbonyl compounds. *J. Dairy Sci.* 72:2474-2477 (1989).

Leppanen O., Ronkainen P., Koivisto T. and Denslow J. A semiautomatic method for the gas chromatographic determination of vicinal diketones in alcoholic beverages. *J. Inst. Brew.* 85:278- 281 (1979).

Martineau B., Acree T. and Henick-Kling T., Effect of wine type on the detection threshold for diacetyl. *Food Res. Int.* 28:139-143 (1995).

Moree-Testa P. and Saint-Jalm Y., Determination of α -dicarbonyl compounds in cigarette smoke. *J. Chromatogr.* 217:197-208 (1981).

De Revel G., Pripis-Nicolau L., Barbe J.-C. and Bertrand A., The detection of α -dicarbonyl compounds in wine by the formation of quinoxaline derivatives. *J. Sci. Food Agric.* 80:102-108 (2000).

De Revel G. and Bertrand A. Dicarbonyl compounds and their reduction products in wine. Identification of wine aldehydes. *Proc 7th Weurman Flavour Research Symp., Zeist, June, pp 353-361 (1994).*

De Revel G. and Bertrand A., A method for the detection of carbonyl compounds in wine: glyoxal and methylglyoxal. *J. Sci. Food Agric.* 61:267-272 (1993).

Voulgaropoulos A., Soilis T. and Andricopoulos N., Fluorimetric determination of diacetyl in wines after condensation with 3,4-diaminoanisole. *Am. J. Enol. Vitic.* 42:73-75 (1991).

Gilles de Revel et Alain Bertrand, Analyse des composés α -dicarbonyles du vin après dérivation par le 1-2-diaminobenzène OIV FV 1275

**Determination of carboxymethyl cellulose (cellulose gum,
CMC) in white wines
(OIV-Oeno 404-2010)**

OIV-MA-AS315-22

Type of method: IV

1. Introduction

Carboxymethyl cellulose (CMC) is a polymer derived from natural cellulose that has been routinely used for many years now as a food additive (INS 466) in products such as ice creams and pre-cooked meals [1], to give them smoothness. The use of CMC in white wines and sparkling wines to contribute to their tartaric stabilisation [2] was recently accepted by the OIV in resolution Oeno 2/2008 provided that the dose added to the wine is less than 100 mg/l. A specific method for determination of CMC in white wine has therefore been developed based on the method of H.D Graham published in 1971 [3].

2. Field of application

The method applies to white wines (still and sparkling).

3. Principle

Once the CMC has been isolated from the wine by dialysis, it is hydrolysed in an acid medium to form glycolic acid which is then degraded to form formaldehyde. 2,7-Dihydroxynaphthalene (DHN) is added to form 2,2,7,7-tetrahydroxydinaphthylmethane in the presence of formaldehyde. The complex formed develops a purple-blue colour under the action of concentrated sulphuric acid, at 100 °C, allowing colorimetric measurement at 540nm (Figure 1).

**COMPENDIUM OF INTERNATIONAL ANALYSIS OF METHODS –
OIV
CMC in white wines**

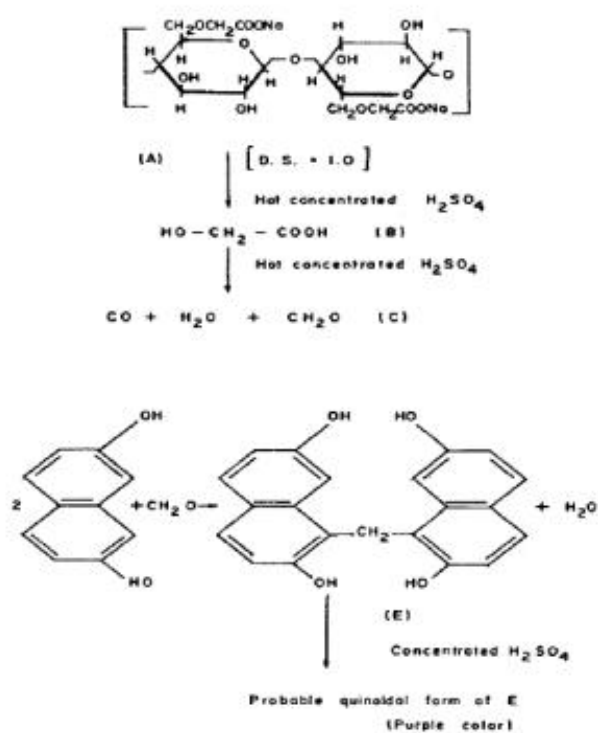

Figure 1: Mechanism of reaction of CMC with DHN in hot concentrated sulphuric acid (Feigl, 1966)

4. Reagents

- Sodium carboxymethylcellulose [N° CAS [9004-32-4](#)] (21902 - average viscosity 400-1000 mPa·s, substitution degree 0.60-0.95)
- 2,7-Dihydroxynaphthalene [N° CAS [582-17-2](#)] (purity > 98,0 % - HPLC)
- 95 % concentrated sulphuric acid
- Purified water for laboratory use (example of quality: EN ISO 3696)

5. Equipment

- Laboratory glassware
- Dialysis membrane (6000 to 8000 Da)
- Temperature-controlled bath
- Double-beam UV-visible spectrophotometer

6. Operating procedure

6.1 Preparation of the reagent

- Place 50 mg of DHN weighed to within 1 mg in a calibrated 100 mL phial.
- Add concentrated sulphuric acid up to the gauge line.
- Place the calibrated phial in a temperature-controlled bath at 28 °C for 4h (without stirring).
- After heating, decant the reagent into a brown flask and store it in a refrigerator at 4 °C.

6.2 Preparation of wine test specimens

- Insert 20 mL of wine, after degassing, into the dialysis membrane.
- Place the dialysis membrane containing the wine in a 6-litre flask filled with distilled water.
- Leave to dialyse for 24h, changing the dialysis water twice.

6.3 Colour reaction

- Place 1 mL of dialysed wine into a test tube.
- Add 9 mL of reagent.
- Place the test tube in a temperature-controlled bath at 100 °C for 2h.
- Analyse the coloured solution by UV-visible spectrophotometer at 540nm and read the absorbance value.

6.4 Calculation of the wine's CMC content

- Recording the absorbance value read in point 6.3 on the calibration curve obtained for a wine (see figure 2)

7. Characteristics of the method

Certain elements of the internal validation were determined but these do not constitute a formal validation according to the protocol governing the planning, the implementing and the interpretation of performance studies pertaining to analysis methods (OIV 6/2000)

7.1 Linearity of the response

A white wine has been added with incremental quantities of CMC ranging between 0 and 100 mg/L, then submitted to dialysis and treated in the conditions defined in the procedure described above. The response is linear for the concentrations under consideration (figure 2).

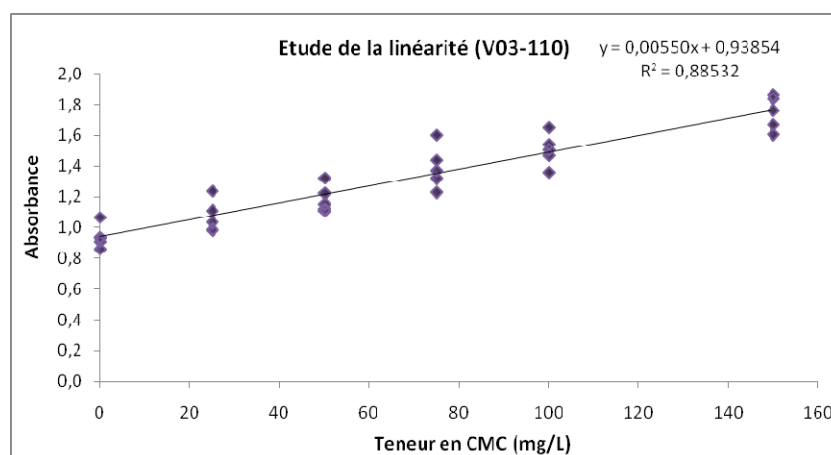

Figure 2: Linearity of CMC determination in white wine

7.2 Repeatability

The repeatability of the determination of CMC in white wines was defined on the basis of the results achieved on 22 samples of wine that underwent 2 successive analyses, so as to be analysed in identical conditions. The results are given in table 1.

**COMPENDIUM OF INTERNATIONAL ANALYSIS OF METHODS –
OIV
CMC in white wines**

	calculated values
Repeatability:	
standard deviation	0,075
CV in %	7,2 %
r-limit	0,21
r-limit in %	20 %

Table 1: Repeatability of CMC determination in white wine

7.3 Reproducibility

The reproducibility of the determination of CMC in white wines was defined through the analysis of a white wine by CMC, on 12 occasions at different dates. The results are given in table 2.

	calculated values
reproducibility	
standard deviation	0,082
CV in %	9,6 %
R-limit	0,23
R-limit in %	27 %

Table 2: Reproducibility of CMC determination in white wine

7.4 Specificity

The specificity of CMC determination was verified by adding known quantities of CMC into white wines. The recovery rates thus measure are given in table 3.

**COMPENDIUM OF INTERNATIONAL ANALYSIS OF METHODS –
OIV
CMC in white wines**

Sample	Added concentration (mg/l)	Resulting concentration (mg/l)	Recovery rate
Wine 1	50	33	66 %
Wine 1	50	51	102 %
Wine 1	50	24	77 %
Wine 2	75	78	104 %
Wine 2	75	90	121 %
Wine 2	75	69	92 %
Wine 3	100	109	109 %
Wine 3	100	97	97 %
Wine 3	100	103	103 %
Wine 4	150	163	109 %
Wine 4	150	149	100 %
Wine 4	150	159	106 %

Table 3: Specificity of CMC determination in white wine

7.4 Detection and quantification limits

The detection limits (LD) and quantification limits (LQ) were calculated for an untreated wine that underwent 10 analyses. The detection limit thus determined is of 14 mg/l and the quantification limit is of 61 mg/l.

The method therefore enables to detect the adding of CMC into white wine in quantities exceeding 20 mg/l and to quantify the addition when it exceeds 60 mg/l; this is not highly satisfactory but remains compatible with the maximum authorised dose of 100 mg/l.

7.5 Uncertainty

The uncertainty was calculated at 3 different concentration levels (25, 75 and 150 mg/l) based on the analysis results for wines that have undergone CMC treatment,

using the standard deviation reproducibility. The uncertainty thus obtained is of 40 mg/l, regardless of the CMC determination.

8. Bibliography

- [1] Regulation (CE) N° 1333/2008 of the 16th of December, 2008 concerning food additives
- [2] Stabilisation tartrique des vins par la carboxyméthylcellulose - Bulletin de l'OIV 2001, vol 74, n°841-842, p151-159.
- [3] Determination of carboxymethylcellulose in food products - H.D Graham, Journal of food science 1971, p 1052-1055

OIV-MA-AS315-23

Type of Method: criteria

**CRITERIA FOR THE METHODS OF QUANTIFICATION
OF POTENTIALLY ALLERGENIC RESIDUES OF
FINING AGENT PROTEINS IN WINE
(OIV-Oeno 427-2010 *modified by* OIV-COMEX 502-2012)**

1 Method Criteria Definitions

Trueness	the closeness of agreement between the average value obtained from a large series of test results and an accepted reference value
$r =$	Repeatability limit, the value below which the absolute difference between 2 single test results obtained under repeatability conditions (i.e., same sample, same operator, same apparatus, same laboratory, and short interval of time) may be expected to lie within a specific probability (typically 95%) and hence $r = 2.8 \times S_r$.
$S_r =$	Standard deviation, calculated from results generated under repeatability conditions.
$RSD_r =$	Relative standard deviation, calculated from results generated under repeatability conditions $[(S_r/\bar{x}) \times 100]$, where \bar{x} is the average of results over all laboratories and samples.
$R =$	Reproducibility limit, the value below which the absolute difference between single test results obtained under reproducibility conditions (i.e., on identical material obtained by operators in different laboratories,

COMPENDIUM OF INTERNATIONAL ANALYSIS OF METHODS – OIV
Criteria for the quantification of potentially allergenic residues of
fining agent proteins in wine

	using the standardised test method), may be expected to lie within a certain probability (typically 95%); $R = 2.8 \times S_R$.
$S_R =$	Standard deviation, calculated from results under reproducibility conditions.
$RSD_R =$	Relative standard deviation calculated from results generated under reproducibility conditions $[(S_R/\bar{x} \times 100)]$
$Ho_R =$	HORRAT value: the observed RSD_R value divided by the RSD_R value calculated from the Horwitz equation.
$B_0 =$	Mean blank
$LOD =$	Limit of detection, calculated as $LOD = B_0 + 3 \times S_r(B_0)$
$LOQ =$	Limit of quantification, calculated as $LOQ = B_0 + 10 \times S_r(B_0)$

2. General Aspects

Requirement

The method of analysis must be associated with specific oenological practices

Additives or processing aids containing allergenic proteins

Each product must be characterized from the chemical point of view and quality control is strictly necessary

Class of analytical methods

Generally speaking, immunoenzymatic approaches are considered the most suitable and easy methods for routine control of allergens.

The determination of allergenic fining agent proteins residues in wines could use Sandwich, Competitive, Direct or Indirect ELISA methods. If no enzyme-labeled antibody is available a biotinylated antibody and avidine-HRP conjugate can be used for detection.

Antibody

- Antibody characterization (evaluation of detection of allergens with higher or lower affinity)
- High specificity for the commercial processing aids (characterized as described above)
- Cross-reactivity characterization taking in account the proteins usually included in enological practices
- Capability to detect allergen derivatives that could be formed by enological treatments (proteolysis or modified molecules)

Method

- Antibody must have optimal binding properties in wine samples
- Methods must have optimal performances in wine samples having different chemical characteristics (pH and dry extract, red and white wine, etc..)
- Results in wines coming from different geographical area (even when different enological practices are applied) must be comparable
- The binding properties of the antibodies must be optimal with different condition of maturation of wine (time, temperatures, color changes ...)

3. Type of methods

Specific methods for the determination of fining agent proteins in wine are not prescribed yet. Several ELISA methods are already available and can be applied.

Laboratories shall use a method validated to OIV requirements that fulfils the performance criteria indicated in Table 1. Wherever possible, the validation shall include a certified reference material in the collaborative

trial test materials. If not available, an alternative estimation of trueness should be used.

The General Protocol for the Direct and Indirect ELISA Method

The direct, one-step method uses only one labeled antibody. This labeled antibody is incubated with the antigen contained in the sample/standard and bound to the well.

The indirect, two-step method uses a labeled secondary antibody for detection. First, a primary antibody is incubated with the antigen contained in the sample/standard and bound to the well. This is followed by incubation with a labeled secondary antibody that recognizes the primary antibody.

Direct

1. Prepare a surface to which antigen in sample is bound.
2. Block any non-specific binding sites on the surface.
3. Apply enzyme-linked antibodies that bind specifically to the antigen.
4. Wash the plate, so that the antibody-enzyme conjugates in excess (unbound) are removed.
5. Apply a chemical which is converted by the enzyme into a color or fluorescent or electrochemical signal.
6. Measure the absorbance or fluorescence or electrochemical signal (e.g., current) of the plate wells to determine the presence and quantity of antigen.

Before the assay, the antibody preparations must be purified and conjugated.

Indirect

1. Prepare a surface to which antigen in sample is bound.
2. Block any non-specific binding sites on the surface.
3. Apply primary antibodies that bind specifically to the antigen
4. Wash the plate, so that primary antibodies in excess (unbound) are removed.
5. Apply enzyme-linked secondary antibodies which are specific to the primary antibodies.
6. Wash the plate, so that the antibody-enzyme conjugates in excess (unbound) are removed.

**COMPENDIUM OF INTERNATIONAL ANALYSIS OF METHODS – OIV
Criteria for the quantification of potentially allergenic residues of
fining agent proteins in wine**

7. Apply a chemical which is converted by the enzyme into a color or fluorescent or electrochemical signal.
8. Measure the absorbance or fluorescence or electrochemical signal (e.g., current) of the plate wells to determine the presence and quantity of antigen.

Before the assay, both antibody preparations must be purified and one must be conjugated.

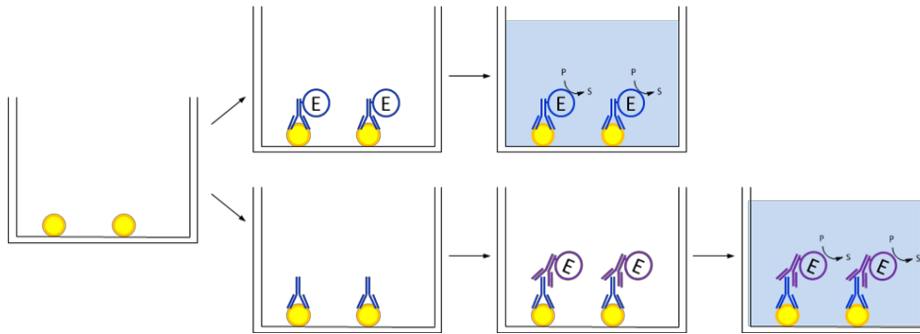

Figure 1: Direct and indirect ELISA

For most applications, a high-binding polystyrene microtiter plate is best; however, consult manufacturer guidelines to determine the most appropriate type of plate for binding the given antigen.

The major advantage of direct and indirect ELISA is the high sensitivity, achieved via a comparably easy set-up with reduced chances of unspecific binding. However, it is only applicable in samples containing low amounts of non-antigen protein.

General Protocol for the competitive ELISA Method

The term "competitive" describes assays in which measurement involves the quantification of a substance by its ability to interfere with an established

system. The detection can be done directly, one-step method, or indirectly, two-step method.

Direct

1. Prepare a surface to which a known quantity of wanted antigen is bound.
2. Block any non-specific binding sites on the surface.
3. Apply the sample or standard (antigen) and the enzyme-linked antibodies that bind specifically to the antigen on the coated microplate. The antigens immobilized on the surface and the antigens in solution “compete” for the antibodies. Hence, the more antigen in the sample, the less antibody will be bound to the immobilized antigens.
4. Wash the plate so that the antibodies in excess (unbound) and unbound antigen-antibody-complexes are removed.
5. Apply a chemical which is converted by the enzyme into a color or fluorescent or electrochemical signal.
6. Measure the absorbance or fluorescence or electrochemical signal (e.g., current) of the plate wells to determine the presence and quantity of antigen.

Before the assay, the antibody preparations must be purified and must be conjugated.

Indirect

1. Prepare a surface to which a known quantity of antigen is bound.
2. Block any non-specific binding sites on the surface.
3. Apply the sample or standard (antigen) and the specific primary antibody to the coated microplate. The antigens immobilized on the surface and the antigens in solution “compete” for the antibodies. Hence, the more antigen in the sample, the less antibody will be bound to the immobilized antigens.
4. Wash the plate so that the antibodies in excess (unbound) and unbound antigen-antibody-complexes are removed.
5. Add a secondary antibody, specific to the primary antibody, conjugated with an enzyme.

6. Wash the plate so that the conjugated antibodies in excess (unbound) are removed
7. Apply a chemical which is converted by the enzyme into a color or fluorescent or electrochemical signal.
8. Measure the absorbance or fluorescence or electrochemical signal (e.g., current) of the plate wells to determine the presence and quantity of antigen.

Before the assay, both antibody preparations must be purified and one must be conjugated.

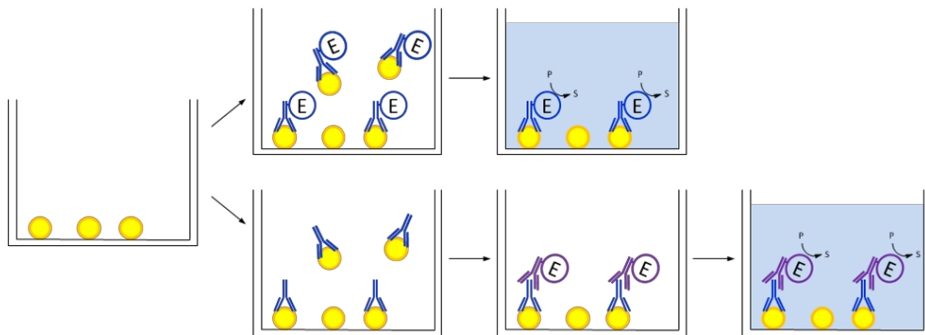

Figure 2: Direct and indirect competitive ELISA

For competitive ELISA, the higher the original antigen concentration, the weaker is the signal.

For most applications, a high-binding polystyrene microtiter plate is best; however, consult manufacturer guidelines to determine the most appropriate type of plate for binding the given antigen.

General Protocol for the Sandwich ELISA Method

The Sandwich ELISA measures the amount of antigen between two layers of antibodies (i.e. capture and detection antibody). The antigen to be measured must contain at least two different antigenic sites (epitopes) for binding two different antibodies. Either monoclonal or polyclonal antibodies can be used.

Direct

1. Prepare a surface to which capture antibody is bound.
2. Block any non-specific binding sites on the surface.
3. Apply the antigen-containing sample or standard to the plate.
4. Wash the plate, so that unbound antigen is removed.
5. Apply enzyme-linked antibodies (detection antibodies) that bind specifically to the antigen.
6. Wash the plate, so that the enzyme-linked antibodies in excess (unbound) are removed.
7. Apply a chemical which is converted by the enzyme into a color or fluorescent or electrochemical signal.
8. Measure the absorbance or fluorescence or electrochemical signal (e.g., current) of the plate wells to determine the presence and quantity of antigen.

Before the assay, both antibody preparations must be purified and one must be conjugated.

Indirect

1. Prepare a surface to which capture antibody is bound.
2. Block any non specific binding sites on the surface.
3. Apply the antigen-containing sample or standard to the plate.
4. Wash the plate, so that unbound antigen is removed.
5. Apply primary antibodies that bind specifically to the antigen.
6. Wash the plate, so that primary antibody in excess (unbound) is removed.
7. Apply enzyme-linked antibodies (secondary antibodies) that bind specifically to the primary antibody.
8. Wash the plate, so that the enzyme-linked antibodies in excess (unbound) are removed.
9. Apply a chemical which is converted by the enzyme into a color or fluorescent or electrochemical signal.
10. Measure the absorbance or fluorescence or electrochemical signal (e.g., current) of the plate wells to determine the presence and quantity of antigen.

Before the assay, all the antibody preparations must be purified and one of them must be conjugated.

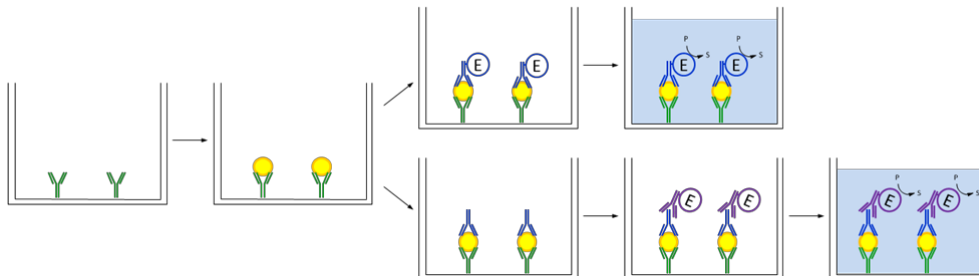

Figure 3: Direct and indirect Sandwich-ELISA

For indirect Sandwich-ELISA, it is necessary for the capture antibodies and the detection antibodies to be raised in different species (e.g. mouse and rabbit), so that the enzyme-linked secondary antibodies specific for the detection antibodies do not bind to the capture antibodies, as well.

For most applications, a high-binding polystyrene microtiter plate is best; however, consult manufacturer guidelines to determine the most appropriate type of plate for binding the given antigen.

For sandwich ELISA, the measure is proportional to the amount of antigen in samples.

The advantage of Sandwich ELISA is that even crude samples do not have to be purified before analysis, and the assay can be very sensitive.

**COMPENDIUM OF INTERNATIONAL ANALYSIS OF METHODS – OIV
Criteria for the quantification of potentially allergenic residues of
fining agent proteins in wine**

Table 1: Performance criteria for methods of analyses for potentially allergenic fining agent proteins in wine

Parameter	Value/Comment
Applicability	Suitable for determining fining agents in wine for official purposes.
Detection limit	(expressed in mg/L) $\leq 0,25$
Limit of quantification	(expressed in mg/L) $\leq 0,5$
Precision	HORRAT values of less or equal to 2 in the validation collaborative trial
Recovery	80% - 105% (as indicated in the collaborative trial)
Specificity	Free from matrix interferences
Trueness	$ \bar{x} - m < 1,96 * \sqrt{S_{R(lab)}^2 - S_{r(lab)}^2 * (1 - 1/n)}$ <p>where m is the certified value of the wine reference material and \bar{x} is the average of n measurements of compound content in this wine, within the same laboratory.</p> <p>$S_{r(lab)}$ are standard deviations, calculated from results within the same laboratory under repeatability conditions.</p> <p>$S_{R(lab)}$ are standard deviations, calculated from results within different laboratories under reproducibility conditions.</p>

Determination of lysozyme in wine using high-
performance capillary electrophoresis

(Revised by Oeno 385/2012)

1. Introduction

This method is used to detect the addition of lysozyme in wine but is not suitable for the assay or determination of lysozyme as an allergenic compound.

Determination of residual lysozyme in treated wines is performed using high-performance capillary electrophoresis (HPCE).

2. Scope

This method applies to lysozyme determination in white wines at concentrations ranging from 9 mg/L to 100 mg / L, and by dilution above this level.

3. Principle

The wine samples are directly injected into the capillary-electrophoresis instrument after filtration and dilution, as needed. The quantification of lysozyme is performed against an external standard.

4. Reagents

Lysozyme extract of chicken egg white [CAS No. 12650-88-3]

85% Phosphoric acid [CAS No. 7664-38-2]

Hydroxypropyl methylcellulose (HPMC) [CAS No 9004-65-3]

COMPENDIUM OF INTERNATIONAL ANALYSIS OF METHODS - OIV
Determination of lysozyme in wine using high-performance
capillary electrophoresis

Purified water for laboratory use, for example to EN ISO 3696 grade (water for analytical laboratory use - specification and test methods [ISO 3696:1987]).

5. Apparatus

Standard laboratory apparatus
Capillary electrophoresis instrument with a UV spectrophotometric detector

6. Sample preparation

The wine to be analysed is diluted four-fold in distilled water for analysis by capillary electrophoresis, in order to fit within the linear dynamic range of the method (lysozyme content lower than 100 mg/l).

7. Analytical conditions

Capillary: fused silica (37 cm length, 75 µm diameter)
Buffer: phosphoric acid (75 mm) HPMC (0.1 %), pH 1.68
Injection time: 15 sec
Injection mode: hydrostatic procedure (3447.38 Pa)
Temperature: 25°C
Applied voltage: 7 kV
Detection: UV 214 nm

8. Calculation

A calibration curve is produced based on lysozyme solutions in water at 10, 20, 50, and 100 mg/l. Depending on the external calibration method, lysozyme quantification is performed by measuring the lysozyme peak area in the wine and comparing it with the corresponding concentration on the calibration curve.

9. Method characteristics

9.1 Linearity of response

As the maximum authorized dose of lysozyme which may be added to wines is 500 mg/l, a standard range containing 5 to 500 mg/l of lysozyme in aqueous solution was prepared. Each solution was analysed five times.

Above 100 mg/l, the response is no longer linear. The linear dynamic range of the method is from 5 to 100 mg/l, as shown on the calibration curve in Figure 1.

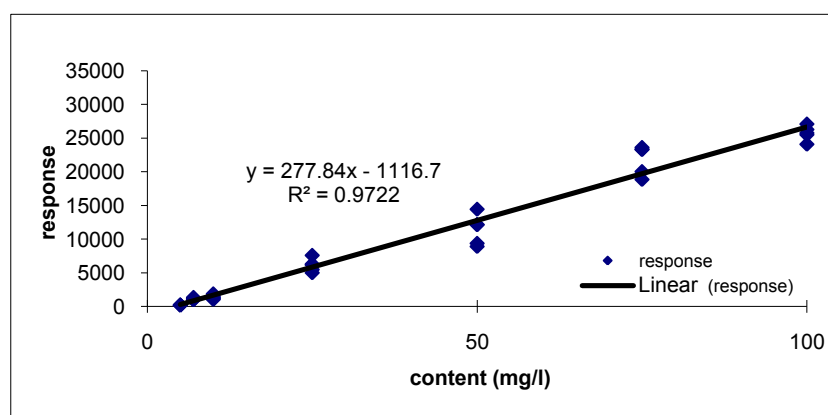

Figure 1: Linearity of lysozyme determination using HPCE

9.2 Repeatability

The repeatability of lysozyme determination in white wines has been determined from the results obtained across 20 wines with added

COMPENDIUM OF INTERNATIONAL ANALYSIS OF METHODS - OIV
Determination of lysozyme in wine using high-performance
capillary electrophoresis

lysozyme, analysed twice in succession, in order to be tested under identical conditions. The results are given in table 1:

Table 1: Repeatability of lysozyme determination using HPCE

Repeatability	Calculated values
standard deviation in mg/L	2.63
CV %	1.4%
r limit in mg/L	7.35
r limit %	4%

9.3 Reproducibility

The reproducibility of lysozyme determination in white wines has been determined by analysing the same white wine, with 200 mg/L of lysozyme added, 8 times on different dates. The results are given in Table 2.

Table 2 - Reproducibility of lysozyme determination using HPCE

Reproducibility	Calculated value
standard deviation in mg/L	11.75
CV %	5.8%
R limit in mg/L	32.90
R limit %	16%

9.4 Limits of detection and quantification

Limits of detection (LoD) and quantification (LoQ) are determined based on the background noise measured near the lysozyme peak corresponding to the first calibration point, i.e. 5 mg/L. The results obtained are as follows:

$$\text{LoD} = 3 \times \text{background noise (mg/L)} = 3 \text{ mg/L}$$

$$\text{LoQ} = 10 \times \text{background noise (mg/L)} = 9 \text{ mg/L}$$

9.5 Uncertainty

Uncertainty was determined using the intralaboratory reproducibility standard deviation, this is 12 %.

10. Bibliography

S. Chauvet, C. Lagrèze, A. Domec, M-H Salagoïty, B. Médina: Dosage du lysozyme dans le vin par électrophorèse capillaire haute performance OIV FV 1274

ME. Barbeito, C. Coria, C. Chiconofri : Influencia del filtrado de vinos para la determinación de lisozima según oeno 8/2007 OIV FV1306

Determination of lysozyme in wine using high-performance liquid chromatography
(Resolution OIV-OENO 458/2014)

1. Introduction

This method describes the analytical procedure used to determine lysozyme in red and white wines. The determination can be carried out on the sample directly for white wines, but for red wines a dissociation of the enzyme from the polyphenolic macromolecules by means of rapid alkalisation must be undertaken, using the principle of the amphoteric nature of the protein.

2. Field of application

This method allows the lysozyme (mg of protein·L⁻¹) content in red and white wines to be quantified independently from enzyme activity. It should be made clear that this method makes it possible to detect lysozyme added to wine, but the limit of detection of the method does not exclude any allergenicity associated with the presence of low levels of lysozyme.

3. Principle

The analysis is carried out using high performance liquid chromatography (HPLC) with a spectrofluorimetric detector. The unknown quantity in the wine sample is calculated according to the chromatographic peak area using the external standard method.

4. Materials and reagents

4.1. Solvents and working solutions

- 4.1.1. Acetonitrile (CH₃CN), HPLC grade (CAS no. 75-05-8)
- 4.1.2. Trifluoroacetic acid (TFA) (CAS no. 76-05-1)
- 4.1.3. Deionised water, HPLC grade (CAS no. 7732-18-5)
- 4.1.4. Lysozyme standard (CAS no. 9001-63-2)
- 4.1.5. Tartaric acid (CAS no. 87-69-4)
- 4.1.6. Ethanol (CAS no. 64-17-5)

COMPENDIUM OF INTERNATIONAL ANALYSIS OF METHODS - OIV
Determination of lysozyme in wine using high-performance liquid chromatography

- 4.1.7. Neutral potassium tartrate (CAS no. 921-53-9)
- 4.1.8. 28% Ammonium hydroxide (w/w) (CAS no. 1336-21-6)
- 4.1.9. 0.65 μm cellulose acetate filters

4.2 Stock solution: 1 $\text{g}\cdot\text{L}^{-1}$ of tartaric acid in 10% ethanol (v/v) adjusted to a pH of 3.2 with neutral potassium tartrate.

4.3 Eluents

- A: 1% CH_3CN , 0.2% TFA, 98.8% H_2O
- B: 70% CH_3CN , 0.2% TFA, 29.8% H_2O

4.4 Reference solution

Solution containing 250 $\text{mg}\cdot\text{L}^{-1}$ lysozyme standard dissolved in the stock solution by stirring continuously for 1 hour. It is stored in a refrigerator for a maximum of 4 weeks.

4.5 Preparation of working solutions

For the working solutions, the reference solution is diluted with the stock solution until the desired concentrations have been reached. These solutions are prepared daily.

5. Equipment

5.1 HPLC apparatus equipped with a pumping system suitable for gradient elution

5.2 Thermostatted column compartment (oven)

5.3 Spectrofluorimetric detector

5.4 20 μL loop injection

5.5 Reverse phase polymeric column with phenyl functional groups (porosity = 1,000 \AA , exclusion limit = 1,000,000 Da), Tosoh Bioscience TSK-gel Phenyl 5PW RP, 4.6 mm ID x 7.5 cm, for example.

5.6 Pre-column in the same material as the column: Tosoh Bioscience TSK-gel Phenyl 5PW RP Guardgel, 3.2 mm ID x 1.5 cm, for example.

6. Operating conditions (by way of example)

6.1 Eluent flow rate: 1 $\text{mL}\cdot\text{min}^{-1}$

6.2 Elution temperature: 40°C

6.3 Spectrofluorimetric detector: $\lambda_{\text{ex}} = 276 \text{ nm}$; $\lambda_{\text{em}} = 345 \text{ nm}$; Gain = 4

6.4 Average lysozyme retention time: 7.9 minutes

COMPENDIUM OF INTERNATIONAL ANALYSIS OF METHODS - OIV
Determination of lysozyme in wine using high-performance liquid chromatography

Time (min)	Mobile phase A (%)	Mobile phase B (%)
0	60	40
10.00	0	100
10.20	60	40
12.00	Controller	Stop

7. Sample preparation

7.1 White wines

White wine samples are filtered using cellulose acetate filters with 0.65 µm porosity and then undergo chromatographic analysis. (There is a lower recovery rate if using nylon filters with 0.45 µm porosity.)

7.2 Red wines

Red wine samples (50 mL) are adjusted to a pH of 11.5. The samples are alkalised using NH₄OH (taking into account the volume of the latter for the final calculation) and are then immediately filtered (after 5 min) using cellulose acetate filters with 0.65 µm porosity and injected into the liquid chromatograph. (There is a lower recovery rate if using nylon filters with 0.45 µm porosity.)

8. Control sample preparation

The reference standard solution (4.4) is added to the sample and it is prepared as described in point 7. The percentage recovery is determined.

9. Expression of results

Adequate resolution was observed for the chromatographic profile of lysozyme standard for the analyte tested, with the below chromatographic conditions (Fig. 1 and Fig.4). Analysis of the lysozyme-free sample enabled the wine profile to be observed without finding any interferences in the enzyme detection (Fig. 2 and Fig. 5).

In white wines, more than 95% of the enzyme was recovered (Fig. 3), while in red wines an enzyme recovery of between 70 and 95% was observed using this method, depending on the polyphenol concentration present in the wine sample (Fig. 6). The result is expressed in milligrams per litre (mg·L⁻¹).

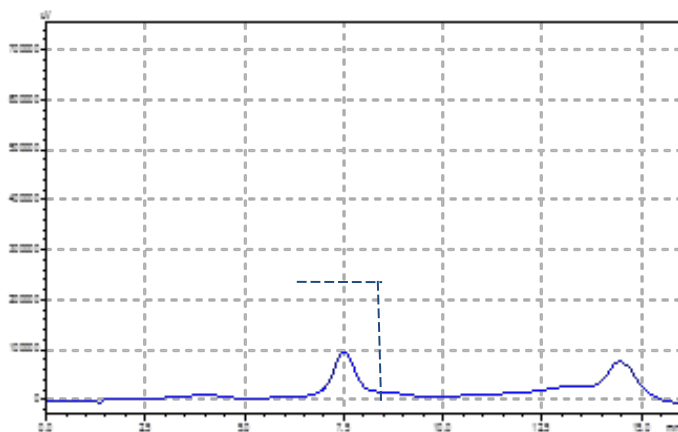

Fig. 1 Chromatogram of the 10 mg·L⁻¹ lysozyme standard

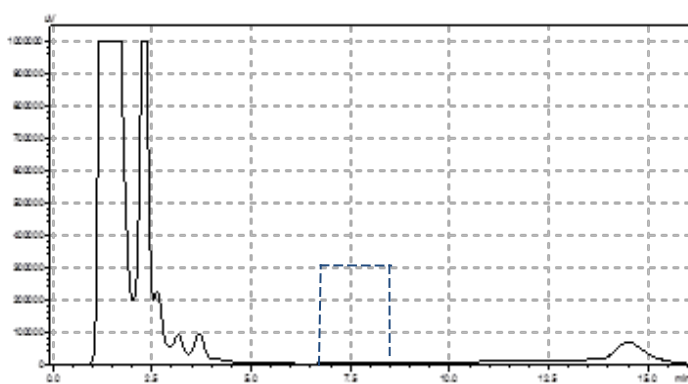

Fig. 2 Chromatogram of a white wine sample without lysozyme

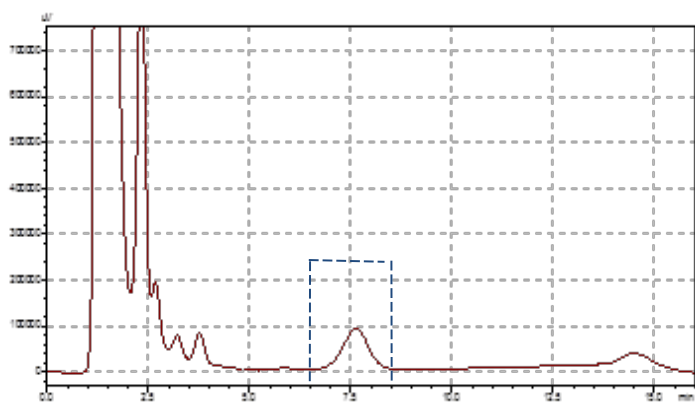

Fig. 3 Chromatogram of a white wine sample with 10 mg·L⁻¹ lysozyme

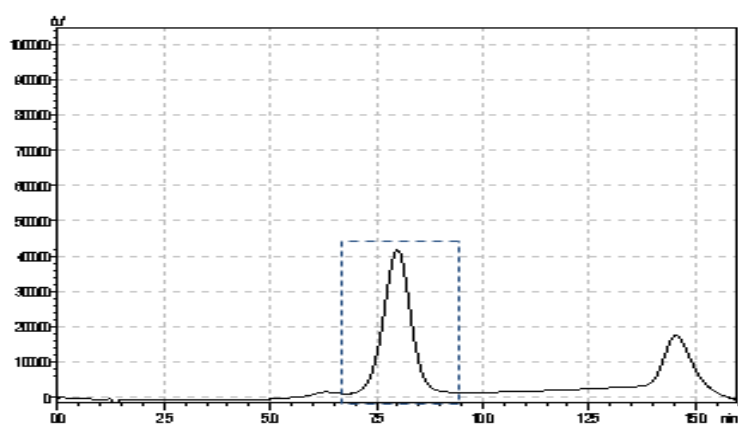

Fig. 4 Chromatogram of the 50 mg·L⁻¹ lysozyme standard

COMPENDIUM OF INTERNATIONAL ANALYSIS OF METHODS - OIV
Determination of lysozyme in wine using high-performance liquid chromatography

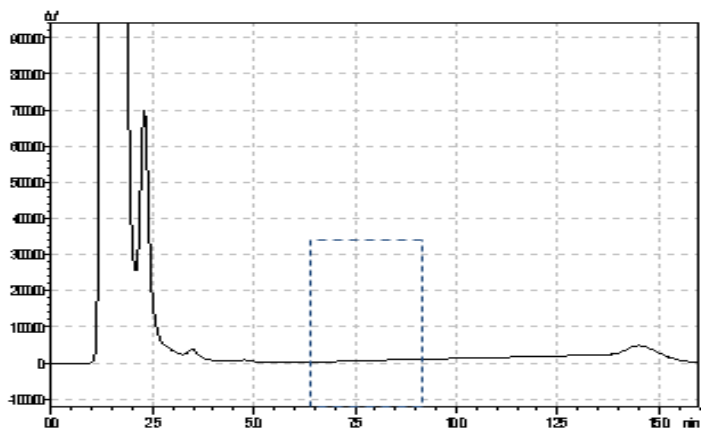

Fig. 5 Chromatogram of a red wine sample without lysozyme

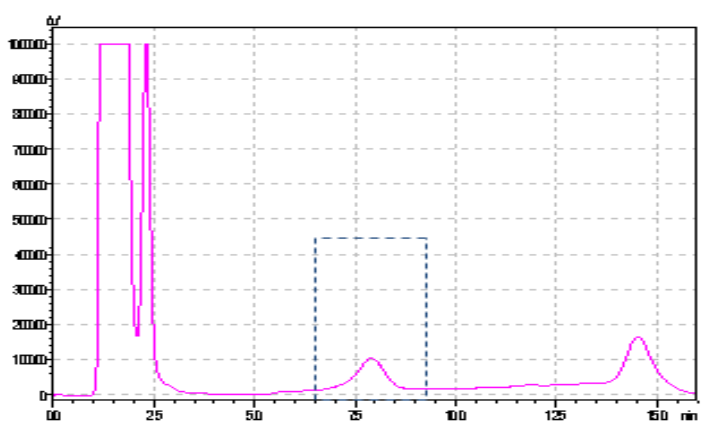

Fig. 6 Chromatogram of a red wine sample with 50 mg·L⁻¹ lysozyme.

10. Analytical procedure for white wines

10.1. Internal validation parameters

10.1.1. Repeatability

The repeatability of the method was studied for the interval between 2 mg·L⁻¹ and 25 mg·L⁻¹ in white wine. 17 samples of white wine enriched with various lysozyme concentrations were analysed in duplicate.

The repeatability results obtained at a probability level of 95% were as follows:

Concentration measured in mg·L⁻¹	Sr mg·L⁻¹	r (2.8xSr) mg·L⁻¹
2	0.25	0.7
5	0.30	0.82
10	0.42	1.1
15	0.61	1.7
25	0.40	1.12

The average repeatability limit (r) is 1.2 mg·L⁻¹

10.1.2. Linearity

For the calculation of linearity, 30 peak area measurements of 6 different concentrations of lysozyme in white wine were conducted, these being: an analytical blank without lysozyme, and concentrations of 2 mg·L⁻¹, 5 mg·L⁻¹, 10 mg·L⁻¹, 15 mg·L⁻¹, and 25 mg·L⁻¹. From these measurements, the y-intercept, the gradient and the coefficient of correlation were calculated.

COMPENDIUM OF INTERNATIONAL ANALYSIS OF METHODS - OIV
Determination of lysozyme in wine using high-performance liquid chromatography

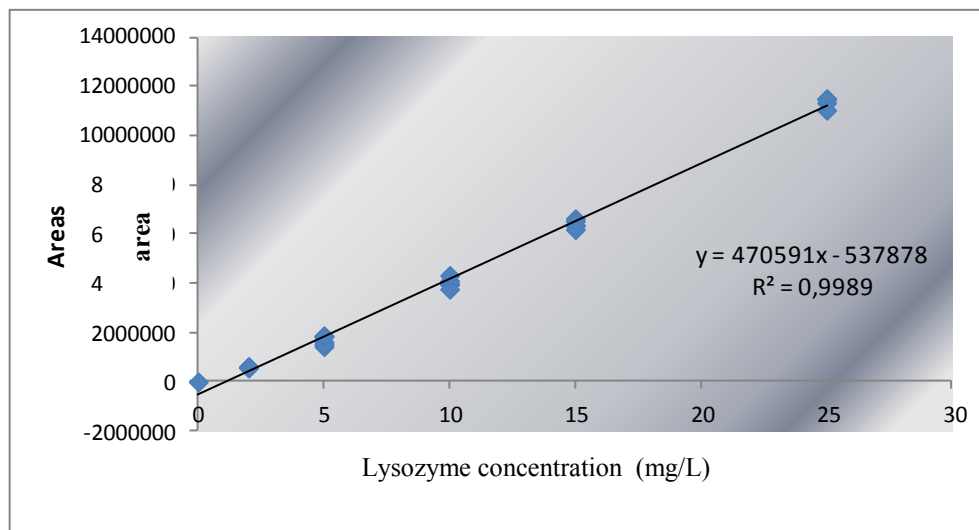

Fig. 7 Dynamic range of lysozyme in white wines up to 25 mg·L⁻¹

10.1.3. Limit of detection and limit of quantification

The limit of detection obtained for this method was calculated using the graphic procedure derived from the background noise of the recording.

The values obtained were as follows:

LOD: 0.49 mg·L⁻¹

LOQ: 1.62 mg·L⁻¹

10.1.4. Intralaboratory reproducibility

The method intralaboratory reproducibility was studied for the interval between 2 mg·L⁻¹ and 25 mg·L⁻¹ in a white wine sample for a 30-day period. It should be pointed out that, due to the instability of the analyte, the wine sample was spiked with the lysozyme reference solution (4.4) on the same day as its analysis. 16 measurements were conducted at regular intervals.

The results obtained were as follows:

COMPENDIUM OF INTERNATIONAL ANALYSIS OF METHODS - OIV
Determination of lysozyme in wine using high-performance liquid chromatography

Concentration measured in mg·L ⁻¹	SR mg·L ⁻¹	R (2.8xSR) mg·L ⁻¹
2	0.19	0.53
5	0.36	1.0
10	0.48	1.3
15	0.64	1.8
25	0.93	2.6

The average reproducibility limit (R) is 1.45 mgL⁻¹

11. Analytical procedure for red wines

11.1 Internal validation parameters

11.1.1. Repeatability

The repeatability of the method was studied for the interval between 5 mg·L⁻¹ and 25 mg·L⁻¹ in red wine. 21 samples of red wine enriched with various lysozyme concentrations were analysed in duplicate.

The repeatability results obtained at a probability level of 95% were as follows:

Concentration measured in mg·L ⁻¹	Sr mg·L ⁻¹	r (2.8xSr) mg·L ⁻¹
5	0.38	1.06
10	0.64	1.79
15	0.59	1.65
25	0.30	0.8

The average repeatability limit (r) is 1.4 mg·L⁻¹

COMPENDIUM OF INTERNATIONAL ANALYSIS OF METHODS - OIV Determination of lysozyme in wine using high-performance liquid chromatography

11.1.2. Linearity

For the calculation of linearity, 25 peak area measurements of 5 different concentrations of lysozyme in red wine were conducted, these being: an analytical blank without lysozyme, and concentrations of 5 mg·L⁻¹, 10 mg·L⁻¹, 15 mg·L⁻¹, and 25 mg·L⁻¹. From these measurements, the y-intercept, the gradient and the coefficient of correlation were calculated.

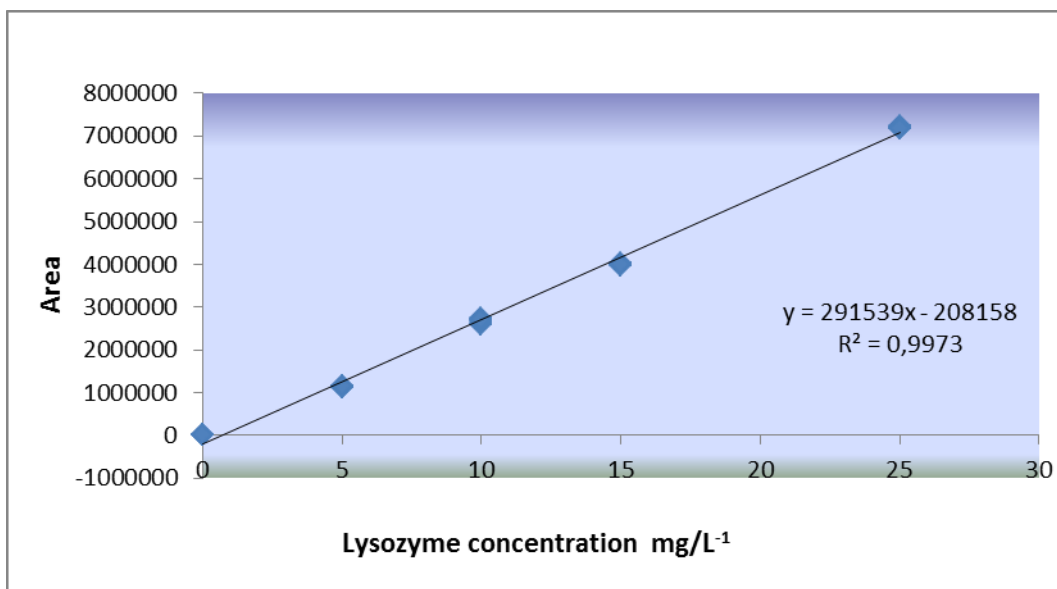

Fig. 8 Dynamic range of lysozyme in red wines up to 25 mg·L⁻¹

11.1.3. Limit of detection and limit of quantification

The limit of detection was calculated using the graphic procedure derived from the background noise of the recording.

The values obtained were as follows:

LOD: 0.88 mg·L⁻¹

LOQ: 2.90 mg·L⁻¹

11.1.4. Intralaboratory reproducibility

The method intralaboratory reproducibility was studied for the interval between 5 mg·L⁻¹ and 25 mg·L⁻¹ in a red wine sample for a 30-day period. It should be pointed out that, due to the instability of the analyte, the wine sample was spiked with the lysozyme reference solution (4.4) on the same day as its analysis. 16 measurements were conducted at regular intervals.

The results obtained were as follows:

Concentration measured in mg·L⁻¹	SR mg·L⁻¹	R (2.8xSR) mg·L⁻¹
5	0.4	1.12
10	0.91	2.54
15	0.54	1.5
25	0.53	1.5

The average reproducibility limit (R) is 1.7 mg·L⁻¹

12. Bibliography

1. Resolution OENO 8-2007 "Measurement of lysozyme in wine by high performance liquid chromatography" (2007).
2. Resolution OENO 10-2005 "A practical guide for the validation, quality control, and uncertainty assessment of an alternative oenological analysis method".

COMPENDIUM OF INTERNATIONAL ANALYSIS OF METHODS - OIV
Method of determination of biogenic amines in wine
by high-performance liquid chromatography
with photodiode array detection

Method OIV-MA-AS315-26

Type IV method

Method of determination of biogenic amines in wine
by high-performance liquid chromatography
with photodiode array detection
(Resolution OIV-OENO 457/2014)

1. Scope

This method is applicable to the analysis of biogenic amines in wines:

Amines	Scope
Histamine	0.500 to 20 mg/L
Methylamine	0.250 to 20 mg/L
Ethylamine	0.450 to 20 mg/L
Tyramine	0.235 to 20 mg/L
Putrescine	0.098 to 20 mg/L
Cadaverine	0.480 to 20 mg/L
Phenethylamine (or Phenylethylamine)	0.096 to 20 mg/L
Isoamylamine	0.020 to 20 mg/L

2. Definition

The word biogenic means "created by life". The term "biogenic amines" is therefore given to all the amines produced by the metabolism of living, animal, plant, or microbial cells. Biogenic amines in wine are mainly of microbial origin. The main ones are histamine, putrescine, cadaverine, and tyramine.

COMPENDIUM OF INTERNATIONAL ANALYSIS OF METHODS - OIV
Method of determination of biogenic amines in wine
by high-performance liquid chromatography
with photodiode array detection

3. Principle

The biogenic amines studied here are primary, secondary, tertiary, aliphatic, or aromatic amines. However, only aromatic amines absorb UV. This is because the detection of molecules by UV requires the presence of a chromophore in the molecule, usually a sequence of conjugated double bonds.

In order to use the HPLC/DAD, it is necessary to couple a chromophore to the biogenic amines. To do so, diethyl 2-(ethoxymethylene)malonate (DEEMM) is used which, by alkylation, also known as derivatisation, enables biogenic amines to be obtained that are visible by diode array detector [1].

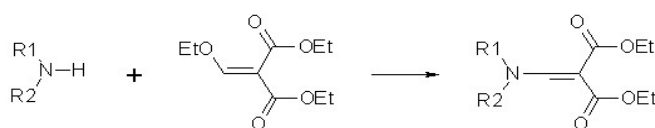

Derivatisation reaction

NB: The yield of the derivatisation is calculated by adding an internal standard (2,4,6-Trimethylphenethylamine hydrochloride or 2,4,6 TPA). Each of the biogenic amines is quantified against a standard range.

COMPENDIUM OF INTERNATIONAL ANALYSIS OF METHODS - OIV
Method of determination of biogenic amines in wine
by high-performance liquid chromatography
with photodiode array detection

4. Reagents and Products

4.1 List of reagents

Product references:

	Product	CAS	Purity
4.1.1	Histamine	51-45-6	≥99%
4.1.2	Methylamine	74-89-5	>99.5%
4.1.3	Ethylamine	557-66-4	97%
4.1.4	Tyramine	60-19-5	≥98%
4.1.5	Putrescine (diaminobutane)	333-93-7	≥98%
4.1.6	Cadaverine (diaminopentane)	1476-39-	≥99%
4.1.7	Phenethylamine	64-04-0	≥99%
4.1.8	Isoamylamine	107-85-7	99%
4.1.9	Boric acid	10043-	≥98.5%
4.1.10	Sodium hydroxide	1310-73-	≥98%
4.1.11	Sodium azide	26628-	≥99.5%
4.1.12	2,4,6-Trimethylphenethylamine	3167-10-	97%
4.1.13	DEEMM (Diethyl 2-	87-13-8	97%
4.1.14	Glacial acetic acid	64-19-7	≥99.7%
4.1.15	Methanol HPLC	67-56-1	≥99.9%
4.1.16	Acetonitrile HPLC	75-05-8	≥99.93%
4.1.17	Hydrochloric acid	7646-01-	≥37%
4.1.18	Ultrapure water (18 MΩ)		

COMPENDIUM OF INTERNATIONAL ANALYSIS OF METHODS - OIV
Method of determination of biogenic amines in wine
by high-performance liquid chromatography
with photodiode array detection

5. Internal standard solution

Preparation of a 2 g/L solution:

Weigh 20 mg of 2, 4, 6-Trimethylphenethylamine hydrochloride (4.1.12)
Dissolve in 10 mL of 0.1 M HCl (5.1)

Storage

The solution is kept at room temperature.

5.1 0.1 M HCL solution

Preparation of a 0.1 M HCl solution:

Take a sample of approximately 900 ml of ultrapure water (4.1.18) using a graduated cylinder (6.13)

Pour approximately 500 mL of ultrapure water (4.1.18) into a 1 L volumetric flask (6.9)

Take a 100 mL sample of 1M HCl (prepared from the commercial product 4.1.17) using a graduated cylinder (6.11)

Pour the 100 mL of 1 M HCl (4.1.17) into the volumetric flask (6.9)

Top up to 1 L with the remaining ultrapure water

Storage

The solution is kept at room temperature.

COMPENDIUM OF INTERNATIONAL ANALYSIS OF METHODS - OIV
Method of determination of biogenic amines in wine
by high-performance liquid chromatography
with photodiode array detection

5.2 1M borate buffer

For 100 mL of solution:

Weigh 6.183 g of boric acid (4.1.9)

Dissolve in a beaker (6.2) by adding 80 mL of ultrapure water (measured using the graduated cylinder) (6.11)

Adjust the pH to 9 with a 4N NaOH solution (prepared from the commercial product 4.1.10)

Adjust to 100 mL in a volumetric flask (6.7)

Note: To obtain good dissolution, the crystals of boric acid should dissolve at a pH as low as possible. To do so, NaOH should be added in small doses (by 10 drops from a Pasteur pipette) (6.30) over a period of 3 hours.

Storage

The solution is kept at room temperature.

5.3 HPLC mobile phase

Mobile phase A: 25 mM acetate buffer + 0.02% of sodium azide pH 5.8:

Take a 1.8 L sample of ultrapure water in a 2 L beaker (6.3)

Add 2.86 mL of glacial acetic acid (4.1.14) (thoroughly rinse the tip in the beaker)

Then 0.4 g of sodium azide (4.1.11)

Stir with a magnetic stirrer (6.24)

Adjust the pH to 5.80 with the 4M NaOH using a Pasteur pipette (6.30) (about 6.5 mL)

Adjust to 2000 mL in a 2000 mL volumetric flask (6.10)

COMPENDIUM OF INTERNATIONAL ANALYSIS OF METHODS - OIV
Method of determination of biogenic amines in wine
by high-performance liquid chromatography
with photodiode array detection

Mobile phase B: Acetonitrile/Methanol (80/20):

For 2 L of mobile phase

Take a 400 mL sample of methanol (4.1.15) using a graduated cylinder (6.12) and pour it into a 2 L cap bottles (6.20) and add in the same cap bottles 1600 mL sample of acetonitrile (4.1.16) measured using a graduated cylinder (6.14).

Storage

The solutions are kept at room temperature.

5.4 Biogenic amine standard range

Preparation of solutions A :

Stock solution A at 500 mg/L

Weigh about 50 mg (accurately known weight) of histamine (4.1.1), methylamine (4.1.2), ethylamine (4.1.3), tyramine (4.1.4) and putrescine (4.1.5) and dissolve them in the same 100 mL flask (6.7) with 0.1 M HCl (5.1)

Surrogate solution A at 50 mg/L

Take a 25 mL sample of solution A at 500 mg/L and pour into a 250 mL flask (6.8)
Top up to 250 mL with 0.1 M HCl (5.1)

Surrogate solution A at 40 mg/L

Take a 50 mL sample of 0.1 M HCl (5.1) and pour into a 250 mL flask (6.8)
Top up to 250 mL with the surrogate solution A at 50 mg/L

COMPENDIUM OF INTERNATIONAL ANALYSIS OF METHODS - OIV
Method of determination of biogenic amines in wine
by high-performance liquid chromatography
with photodiode array detection

Preparation of solutions B

Stock solution B at 500 mg/L

Weigh about 50 mg (accurately known weight) of cadaverine (4.1.6), phenethylamine (4.1.7) and isoamylamine (4.1.8) and dissolve them in the same 100 mL flask (6.7) with 0.1 M HCl (5.1)

Surrogate solution B at 50 mg/L

Take a 25 mL sample of solution B to 500 mg/L and pour into a 250 mL flask (6.8)
Top up to 250 mL with 0.1 M HCl (5.1)

Surrogate solution B at 10 mg/L

Take a 50 mL sample of surrogate solution B at 50 mg/L and pour into a 250 mL flask (6.8)
Top up to 250 mL with 0.1 M HCl (5.1)

Combination of solutions A and B - Standard range

In a 100 mL flask (6.7) add 50 mL of solution A at 40 mg/L using a 50 mL volumetric flask (6.6)

Top up to 100 mL with the solution B at 10 mg/L: you obtain the **solution at 20 (A) / 5 (B) mg/L**

The next table explains how to prepare concentration points for the calibration curve:

Concentration of the initial solution	Volume of initial solution sampled	Adjusted to 100 mL with a 0.1 M	Concentration of the final solution
20(A) / 5 (B)	50	50	10 (A) / 2.5 (B)
10(A) / 2.5 (B)	50	50	5 (A) / 1.25 (B)
5(A) / 1.25 (B)	20	80	1 (A) / 0.25 (B)

In this way, four concentrations of biogenic amines are contained in solution A (20, 10, 5 and 1 mg/L), and four concentrations of biogenic amines are contained in solution B (5, 2.5, 1.25 and 0.25 mg/L).

Storage The solutions are kept at -20°C.

COMPENDIUM OF INTERNATIONAL ANALYSIS OF METHODS - OIV
Method of determination of biogenic amines in wine
by high-performance liquid chromatography
with photodiode array detection

6. Equipment and apparatus

- 6.1 25 mL Beakers
- 6.2 250 mL Beakers
- 6.3 2000 mL Beakers
- 6.4 10 mL volumetric flasks
- 6.5 25 mL volumetric flasks
- 6.6 50 mL volumetric flasks
- 6.7 100 mL volumetric flasks
- 6.8 250 mL volumetric flasks
- 6.9 1000 mL volumetric flasks
- 6.10 2000 mL volumetric flasks
- 6.11 100 mL graduated cylinder
- 6.12 500 mL graduated cylinder
- 6.13 1000 mL graduated cylinder
- 6.14 2000 mL graduated cylinder
- 6.15 200 µL automatic pipette
- 6.16 1 mL automatic pipette
- 6.17 5 mL automatic pipette
- 6.18 10 mL automatic pipette
- 6.19 Tips for 1 mL, 5 mL and 10 mL automatic pipette
- 6.20 2-litre cap bottles
- 6.21 Pyrex 10 mL hydrolysis tubes with screw top
- 6.22 2 mL screw cap bottles adapted to the auto-sampler
- 6.23 Scales for weighing from 0 to 205 g
- 6.24 Magnetic stirrer
- 6.25 High-performance liquid chromatography (HPLC)
- 6.26 Data acquisition software
- 6.27 DAD detector (diode array)
- 6.28 Octadecyl-type column (for example HP® C18 - HL, 250 mm x 4.6 mm, 5 µm).
- 6.29 Dry bath at 70 ° C
- 6.30 Pasteur pipette
- 6.31 Ultrasonic bath

7. Sampling (sample preparation)

This method does not require special sampling in that 1 mL of wine to be analysed is collected and deposited directly into a Pyrex 10 mL hydrolysis tube with a screw cap (6.21) (see procedure).

However, it is recommended to carry out the derivatisation reaction with DEEMM on receipt of the sample because the histamine concentration in wine may reduce over time.

8. Procedure

8.1 Test sample

The manipulation must be done under a fume hood because of the toxicity of certain of the reagents.

If the buffer contains borate crystals, heat it to 50°C while stirring (lower initially, until the solution has heated up).

To avoid any risk of adsorption on the tips of the automatic pipettes, it is advisable to use the micropipette as follows:

- Pre-wet the cone once with the solution to be sampled
- Add the solution to the recipient without rinsing the tip with the contents of the recipient unless otherwise specified

Shake the solutions well before use (especially the frozen wine)

In a Pyrex 10 mL hydrolysis tube with a screw cap (6.21), introduce using suitable micropipettes:

- 1.75 mL of borate buffer (5.2)
- 750 µL of methanol (4.1.15)
- 1 mL of the sample to be derivatised (1 mL automatic pipette) (6.16)

COMPENDIUM OF INTERNATIONAL ANALYSIS OF METHODS - OIV
Method of determination of biogenic amines in wine
by high-performance liquid chromatography
with photodiode array detection

- 40 µL of the internal standard (2,4,6 TPA to 2 g/L) (5.1)
- 30 µL of DEEMM (4.1.13)

Close the tube (fully tighten to avoid any evaporation) and shake manually.

Turn on the dry bath (6.29) to 70°C.

Place the tube in the ultrasonic bath (6.31) for 30 minutes (2 times 15 minutes, stirring every 5 minutes). Always use a plastic rack suitable for the water bath because the derivatisation is unsatisfactory when a metal rack is used.

Heat the reaction mixture to 70°C for 1h in the dry bath (6.29) to degrade the surplus DEEMM.

Turn off the dry bath

After the reaction mixture has returned to room temperature, fill the 2 mL bottles using Pasteur pipettes (6.30) (change Pasteur pipette with each tube). Shake the tubes manually before sampling.

8.2 Operating conditions

The operating conditions below are given as an example.

Mobile phase:

- A: 25 mM acetate buffer + 0.02% of sodium azide pH 5.8 :
- B: Acetonitrile/Methanol (80/20):

COMPENDIUM OF INTERNATIONAL ANALYSIS OF METHODS - OIV
Method of determination of biogenic amines in wine
by high-performance liquid chromatography
with photodiode array detection

Gradient elution as follows, with a flow rate of 0.9 mL/min:

Time (min)	% A	% B
0	90	10
5	90	10
10	83	17
35	60	40
43	28	72
48	18	82
52	0	100
57	0	100

Column temperature: 15°C

Detection wavelength: 280 nm

Flow rate: 0.9 ml/min

Volume injected: 50 µL

Analysis time: 57 minutes

Identification of biogenic amines:

The biogenic amines are identified by their retention time. To do so, each biogenic amine was analysed individually in order to determine its retention time (Tr).

Amines		Average Tr (min)
Histamine	HI	25.46
Methylamine	ME	33.11
Ethylamine	ET	39.00
Tyramine	TY	41.50
Putrescine	PU	46.00
Cadaverine	CA	48.00
Phenethylamine	PH	48.75
Isoamylamine	IS	50.25
Internal standard	2,4,6-TPA	54.75

9. Calculations (Results)

Bias caused by the uncertainty on the derivatisation yield and the injection volume can be corrected using the internal standard.

Once the value of the peak has been corrected, the concentration of biogenic amine is calculated based on the slope value of the standard range of the corresponding biogenic amine. To do so, for each series of analyses a standard range is also derivatised and injected.

The results are expressed in mg/L to one figure after the decimal point.

10. Quality Control

Quality controls can be carried out with certified reference materials, wines whose characteristics are derived from consensus or wines to which standard additions have been regularly made during the analytical series and in accordance with the accompanying control charts.

11. Characteristics of the method: intralaboratory validation parameters

The validation parameters were determined according to [4].

11.1 Linearity

The approach chosen for the study of linearity is that of comparing the residual standard deviations from a linear regression model and a second-order polynomial regression model.

This study was conducted on two different wines spiked with biogenic amines at concentrations of 0, 1, 5, 10, and 20 mg / L (solution A) and 0, 0.25, 1.25, 2.5, and 5 mg/L (solution B).

Summary of the results for biogenic amines:

COMPENDIUM OF INTERNATIONAL ANALYSIS OF METHODS - OIV
Method of determination of biogenic amines in wine
by high-performance liquid chromatography
with photodiode array detection

biogenic Amine	S _{res} Linear	S' _{res} Order 2	DS 2	PG	F (5%)	Conclusion
Methylamine	0.766	0.606	3.218	8.757	4.75	Linear
Ethylamine	0.371	0.371	0.140	1.014		Linear
Tyramine	1.065	1.065	1.135	1.000		Linear
Putrescine	0.524	0.523	0.286	1.043		Linear
Cadaverine	0.276	0.267	0.134	1.881		Linear
Phenethylamine	0.251	0.248	0.082	1.328		Linear
Isoamylamine	0.216	0.215	0.055	1.199		Linear
Histamine	0.591	0.589	0.316	1.084		Linear

11.2 Specificity

The principle of specificity measurement consists in examining the regression line $r = a + bv$ and verifying that slope b is equal to 1 ($T_{obs} < T_{critical}$) and that intercept point a is equal to 0 ($T'_{obs} < T_{critical}$). The hypotheses are tested using a t-test associated with the 1% risk of error.

The value of $T_{critical}$, bilateral [p=2, 1%] associated with the 1% risk of error for 3 degrees of freedom is 4.541.

Summary of the results for biogenic amines

biogenic Amine	Wine A		Wine B		Wine C		Wine D	
	T _{obs}	T' _{obs}	T _{obs}	T' _{obs}	T _{obs}	T' _{obs}	T _{obs}	T' _{obs}
Methylamine	4.482	2.321	2.933	0.013	1.563	0.007	5.199	2.864
Ethylamine	0.411	0.002	0.081	0.010	0.546	10.556	0.169	2.537
Tyramine	1.834	0.005	0.636	0.005	2.151	4.485	3.420	37.419
Putrescine	7.605	0.041	0.604	0.000	3.257	0.064	2.135	0.011
Cadaverine	5.499	0.033	1.719	1.314	10.929	0.049	8.466	0.026
Phenethylamine	3.348	0.016	1.265	0.001	10.238	0.034	5.925	0.009
Isoamylamine	12.980	0.016	2.297	0.004	12.996	0.020	11.121	0.000
Histamine	4.978	0.250	1.222	0.006	3.128	0.014	1.229	0.004

COMPENDIUM OF INTERNATIONAL ANALYSIS OF METHODS - OIV
Method of determination of biogenic amines in wine
by high-performance liquid chromatography
with photodiode array detection

11.3 Repeatability

For this repeatability study, seven different red wines were selected, and three different repetitions were performed on each. Concentrations were from 0.5 mg/L to 15 mg/L depending on the biogenic amine and the wine.

biogenic Amine	S _r (mg/L)	r (mg/L)	Validation range (mg/L)
Methylamine	0.335	0.937	3 - 16
Ethylamine	0.173	0.486	2 - 7
Tyramine	0.276	0.773	2 - 20
Putrescine	0.500	1.400	7 - 26
Cadaverine	0.025	0.069	0.2 - 0.8
Phenethylamine	0.028	0.079	0.3 - 1.1
Isoamylamine	0.017	0.048	0.1 - 0.8
Histamine	0.108	0.303	5 - 16

11.4 Reproducibility

For this reproductibility study, three different red wines were selected, and two repetitions were performed with each.

biogenic Amine	S _r (mg/L)	R (mg/L)	Validation range (mg/L)
Methylamine	0.533	1.492	3 - 16
Ethylamine	0.884	2.475	2 - 7
Tyramine	0.341	0.955	2 - 20
Putrescine	0.419	1.172	7 - 26
Cadaverine	0.172	0.482	0.2 - 0.8
Phenethylamine	0.053	0.150	0.3 - 1.1
Isoamylamine	0.056	0.157	0.1 - 0.8
Histamine	1.333	3.732	5 - 16

COMPENDIUM OF INTERNATIONAL ANALYSIS OF METHODS - OIV
Method of determination of biogenic amines in wine
by high-performance liquid chromatography
with photodiode array detection

11.5 Limits of detection (LOD) and limits of quantification (LOQ)

According to an intralaboratory study using the method of successive dilutions from a solution to 0.5 mg/L serially diluted to 0.01 mg/L :

Amines		LD (mg/L)	LQ (mg/L)
Histamine	HI	0.167	0.500
Methylamine	ME	0.083	0.250
Ethylamine	ET	0.150	0.450
Tyramine	TY	0.078	0.235
Putrescine	PU	0.033	0.098
Cadaverine	CA	0.160	0.480
Phenethylamine	PH	0.032	0.096
Isoamylamine	IS	0.007	0.020

12. Bibliography

- [1] Gomez-Alonzo S., Hermosin-Gutierrez I., Garcia-Romero E., 2007. Simultaneous HPLC analysis of biogenic amines, amino acids, and ammonium Ion as Aminoenone derivatives in wine and beer samples. *Journal of Agricultural and Food Chemistry*, 55, 608-613.
- [2] Tricard C., Cazabeil J.-M., Salagoïti M.H. (1991): dosage des amines biogènes dans les vins par HPLC, *Analisis*, 19, M53-M55.
- [3] RECUEIL DES METHODES INTERNATIONALES D'ANALYSES - OIV, Amines biogènes par HPLC, Méthode OIV-MA-AS315-18 , Analyse des amines biogènes des moûts et des vins par HPLC (Résolution OIV-Oeno 346-2009).
- [4] "Guide pratique pour la validation, le contrôle qualité et l'estimation de l'incertitude d'une méthode d'analyse œnologique alternative". Oeno Resolution 10/2005. OIV. October 2005. www.oiv.int.

**Analysis of volatile compounds in wines by gas
chromatography**

(Resolution OIV-OENO 553/2016)

1 – Object

This method is applicable to the analysis of volatile compounds in wines containing less than 20 g/L sugar.

For wines with a sugar content higher than 20 g/L and for mistelles, prior distillation (identical to that practised to obtain the ABV) is necessary; however distillation sometimes removes a significant part of the compounds.

2 – Scope of application

The present method may be used for the quantification of the following compounds (non-exhaustive list):

- ethanal,
- ethyl acetate,
- methanol,
- butan-2-ol,
- propan-1-ol,
- 2-methylpropan-1-ol,
- isoamyl acetate,
- butan-1-ol,
- 2-methylbutan-1-ol,
- 3-methylbutan-1-ol,
- pentan-1-ol,
- acetoin,
- ethyl lactate,
- hexan-1-ol,
- 3-ethoxypropanol,
- ethyl octanoate,
- furfuraldehyde,
- (2R,3R)-butane-2,3-diol,
- (2R,3S)-butane-2,3-diol,

- propane-1,2-diol,
- butyrolactone,
- diethyl succinate,
- hexanoic acid (semi-quantitative),
- 2-phenylethanol,
- diethyl malate,
- octanoic acid (semi-quantitative),
- decanoic acid (semi-quantitative).

Note: diacetyl and acetic acid cannot be quantified by this method yet they appear in the chromatograms.

3 – Principle

Volatile compounds are quantified by gas chromatography after direct injection of the sample, added with an internal standard, into a capillary column coated with a bonded polar phase and detection using flame ionisation.

4 – Reagents and products

The quantities and method of preparation are given by way of example and may be adapted as necessary to the types of wine.

- 4.1 - Demineralised water (e.g. ISO 3696 type II or resistivity $\geq 18 \text{ M}\Omega\cdot\text{cm}$);
- 4.2 - ethanol [CAS no. 64-17-5], purity $\geq 96\%$;
- 4.3 - high-purity hydrogen for GC (e.g. $\text{H}_2\text{O} \leq 4 \text{ ppm}$; $\text{O}_2 \leq 2 \text{ ppm}$; $\text{C}_n\text{H}_m \leq 0.5 \text{ ppm}$; $\text{N}_2 \leq 4 \text{ ppm}$);
- 4.4 - high-purity helium for GC ($\text{H}_2\text{O} \leq 3 \text{ ppm}$; $\text{O}_2 \leq 2 \text{ ppm}$; $\text{C}_n\text{H}_m \leq 1 \text{ ppm}$; $\text{N}_2 \leq 5 \text{ ppm}$);
- 4.5 - high-purity compressed air for GC;
- 4.6 - ethanal [CAS no. 75-07-0], purity $\geq 99\%$;
- 4.7 - ethyl acetate [CAS no. 141-78-6], purity $\geq 99.5\%$;
- 4.8 - methanol [CAS no. 67-56-1], purity $\geq 99.8\%$;
- 4.9 - diacetyl [CAS no. 431-03-08], purity $\geq 99\%$;
- 4.10 - butan-2-ol [CAS no. 15892-23-6], purity $\geq 99.5\%$;
- 4.11 - propan-1-ol [CAS no. 71-23-8], purity $\geq 99.5\%$;
- 4.12 - 2-methylpropan-1-ol [CAS no. 78-83-1], purity $\geq 99.5\%$;
- 4.13 - isoamyl acetate [CAS no. 123-92-2], purity $\geq 97\%$;
- 4.14 - butan-1-ol [CAS no. 71-36-3], purity $\geq 99.5\%$;
- 4.15 - 4-methylpentan-2-ol (internal standard) [CAS no. 108-11-2], purity $\geq 99\%$;
- 4.16 - 2-methylbutan-1-ol [CAS no. 137-32-6], purity $\geq 99\%$;
- 4.17 - 3-methylbutan-1-ol [CAS no. 125-51-3], purity $\geq 99.5\%$;

RECUEIL INTERNATIONAL DES METHODES D'ANALYSES – OIV
Analysis of volatile compounds in wines by gas chromatography

- 4.18 - pentan-1-ol [CAS no. 71-41-0], purity \geq 99%;
- 4.19 - acetoin [CAS no. 513-86-0], purity \geq 96%;
- 4.20 - ethyl lactate [CAS no. 687-47-8], purity \geq 98%;
- 4.21 - hexan-1-ol [CAS no. 111-27-3], purity \geq 99.0%;
- 4.22 - 3-ethoxypropanol [CAS no. 111-35-3], purity \geq 97%;
- 4.23 - ethyl octanoate [CAS no. 106-32-1], purity \geq 99%;
- 4.24 - furfuraldehyde [CAS no. 98-01-1], purity \geq 99.0%;
- 4.25 - acetic acid [CAS no. 64-19-7], purity \geq 99%;
- 4.26 - (2R,3R)- and (2R,3S)-butane-2,3-diol [CAS no. 513-85-9], purity \geq 98%;
- 4.27 - propane-1,2-diol [CAS no. 57-556], purity \geq 99.5%;
- 4.28 - butyrolactone [CAS no. 96-48-0], purity \geq 99%;
- 4.29 - diethyl succinate [CAS no. 123-25-1], purity \geq 99%;
- 4.30 - hexanoic acid [CAS no. 142-62-1], purity \geq 99.5%;
- 4.31 - 2-phenylethanol [CAS no. 60-12-8], purity \geq 99%;
- 4.32 - diethyl malate [CAS no. 7554-12-3], purity \geq 97%;
- 4.33 - octanoic acid [CAS no. 124-07-2], purity \geq 99.5%;
- 4.34 - decanoic acid [CAS no. 334-48-5], purity \geq 99.5%.

Note: diacetyl and acetic acid cannot be quantified by this method yet they appear in the chromatograms.

Preparation of reagent solutions (the quantities are given by way of example and may be adapted as necessary to the types of matrix to be analysed)

4.35 - 10% Aqueous-alcoholic mixture to be made up with ethanol (4.2) and water (4.1).

4.36 - Internal standard solution

Transfer 1 mL 4-methylpentan-2-ol (4.15) into a 100-mL flask (5.2). Fill up to the calibration mark with ethanol (4.2). Divide into flasks on which the date of preparation is noted. Keep refrigerated.

4.37 - Internal or external reference wine (a CRM (Certified Reference Material) wine or a wine used as a reference material from a proficiency-testing programme between laboratories for example).

4.38 - Stock calibration solution

The compounds are individually weighed at \pm 1 mg (nominal weights given in the table below) using a precision balance (5.4). In order to avoid losses through evaporation, quickly add a small amount of ethanol (4.2). Mix and pour into a 1-L flask (5.3). Rinse with ethanol. Add 2.5 mL 4-methylpentan-2-ol (4.15). Make up to 1 L with ethanol (4.2) and mix. Divide into flasks and store in the freezer. Record the exact weights.

RECUEIL INTERNATIONAL DES METHODES D'ANALYSES – OIV
Analysis of volatile compounds in wines by gas chromatography

Compound	Nominal weight (mg)	Final concentration in the working calibration solution 4.39 (mg/L)	Compound	Nominal weight (mg)	Final concentration in the working calibration solution 4.39 (mg/L)
Ethanal (4.6)	500	50	Hexan-1-ol (4.21)	300	30
Ethyl acetate (4.7)	1500	150	3-Ethoxypropanol (4.22)	160	16
Methanol (4.8)	650	65	Furfuraldehyde (4.24)	50	5
Diacetyl (4.9)	50	5	Ethyl octanoate (4.23)	120	12
Butan-2-ol (4.10)	160	16	Acetic acid (5.25)	5000	500
Propan-1-ol (4.11)	350	35	Butane-2,3-diol (4.26)	4000	400
2-Methylpropan-1-ol (4.12)	240	24	Propane-1,2-diol (4.27)	1000	100
Isoamyl acetate (4.13)	250	25	Butyrolactone (4.28)	50	5
Butan-1-ol (4.14)	160	16	Diethyl succinate (4.29)	500	50
2-Methylbutan-1-ol (4.16)	160	16	Hexanoic acid (4.30)	250	25
3-Methylbutan-1-ol (4.17)	1000	100	2-Phenylethanol (4.31)	500	50
Pentan-1-ol (4.18)	160	16	Diethyl malate (4.32)	1000	100
Acetoin (4.19)	250	25	Octanoic acid (4.33)	500	50
Ethyl lactate (4.20)	1500	150	Decanoic acid (4.34)	750	75

4.39 - Working calibration solution

Just before use, dilute the stock calibration solution (4.38) ten times.

5 – Apparatus

5.1 - 20-mL volumetric flasks (class A);

5.2 - 100-mL volumetric flasks (class A);

5.3 - 1-L volumetric flasks (class A);

5.4 - precision balance with an accuracy of ± 1 mg;

5.5 - gas chromatograph equipped with:

- "split-splitless" injector,
- autosampler (optional),
- detector: flame ionisation (FID);

5.6 - fused-silica capillary column:

- Carbowax 20 M type with a bonded polar phase,
- 50 m in length,
- internal diameter of 0.32 mm,
- film thickness of 0.45 μm .

Note: other systems may be used on condition that they are capable of satisfactorily separating the different compounds.

6 – Preparation of the samples

Conduct a preliminary degassing of sparkling wine samples (for example, by first taking a sample using an automatic pipette and collecting it in a tube).

Distil the wines containing more than 20 g/L of sugar and the mistelles prior to preparation.

Introduce the sample into a 20-mL flask (5.1). Add 0.5 mL internal standard solution (4.36) and fill up to the calibration mark with wine.

7 – Procedure

Analyse using the gas chromatograph (5.5) equipped with a capillary column (5.6).

Analytical conditions (given by way of example):

Carrier gas (4.4): $P_{\text{helium}} = 90$ kPa

Note: another carrier gas such as hydrogen may be used, but nitrogen is best avoided.

RECUEIL INTERNATIONAL DES METHODES D'ANALYSES – OIV
Analysis of volatile compounds in wines by gas chromatography

Septum flow rate: 2.5 mL/min

Split flow rate: 40 mL/min

Split mode of injection

Volume injected: 1 µL

Temperature of the injector: 200 °C

Detector: FID (flame ionisation)

Detector temperature at 250 °C

Flame: P_{hydrogen (4.3)} = 50 kPa and P_{air (4.5)} = 130 kPa

Temperature programming:

. temp. 1 = 32 °C at 2.5 °C/min, up to 80 °C - t₁ = 0 min

. temp. 2 = 80 °C at 4 °C/min, up to 170 °C - t₂ = 20 min

. temp. 3 = 170 °C at 10 °C/min, up to 220°C - t₃ = 20 min

Calibration

Inject the working calibration solution (4.39) before each analysis series.

Calculation of response factors:

$$RF_i = (\text{area}_i \times C_{cIS}) / (C_{c_i} \times \text{area}_{IS})$$

C_{c_i} = concentration of the constituent of the calibration solution

Area_i = area of the constituent of the calibration solution

C_{cIS} = concentration of the internal standard in the calibration solution

Area_{IS} = area of the internal standard in the calibration solution

It is also possible to use a calibration curve.

By way of example, chromatograms of a standard solution and a wine sample are given in the Annexes.

8 – Calculations

In the case of use of a response factor, calculation of the concentrations is as follows:

$$C_{c_i} = (\text{area}_i \times C_{cIS}) / (RF_i \times \text{area}_{IS}).$$

9 – Precision

See Annex C.

10 – Quality assurance and control

Traceable to the international references through mass, volume and temperature.

RECUEIL INTERNATIONAL DES METHODES D'ANALYSES – OIV
Analysis of volatile compounds in wines by gas chromatography

Synthetic mixtures or samples coming, for instance, from proficiency ring test are used as internal quality control. A control chart may be used.

11 – Results

Express concentrations in mg/L to the number of decimal places indicated below.

Analytical parameters	No. of decimal places	Analytical parameters	No. of decimal places
Ethanal	0	Ethyl lactate	0
Ethyl acetate	0	Hexan-1-ol	1
Methanol	0	3-Ethoxypropanol	0
Butan-2-ol	1	Ethyl octanoate	0
Propan-1-ol	0	Furfuraldehyde	1
2-Methylpropan-1-ol	0	(2R,3R)-Butane-2,3-diol	0
Isoamyl acetate	1	(Meso)-butane-2,3-diol	0
Butan-1-ol	1	Propane-1,2-diol	0
2-Methylbutan-1-ol	0	Butyrolactone	0
3-Methylbutan-1-ol	0	Diethyl succinate	0
Pentan-1-ol	1	2-Phenylethanol	0
Acetoin	0	Diethyl malate	0

Annex A
Bibliography

-  BERTRAND A., GUEDES DE PINHO P. and ANOCIBAR BELOQUI A.
(1994). *Les constituants majoritaires du vin*, FV 971, OIV, 15 pages.

ANNEX B
Example chromatograms

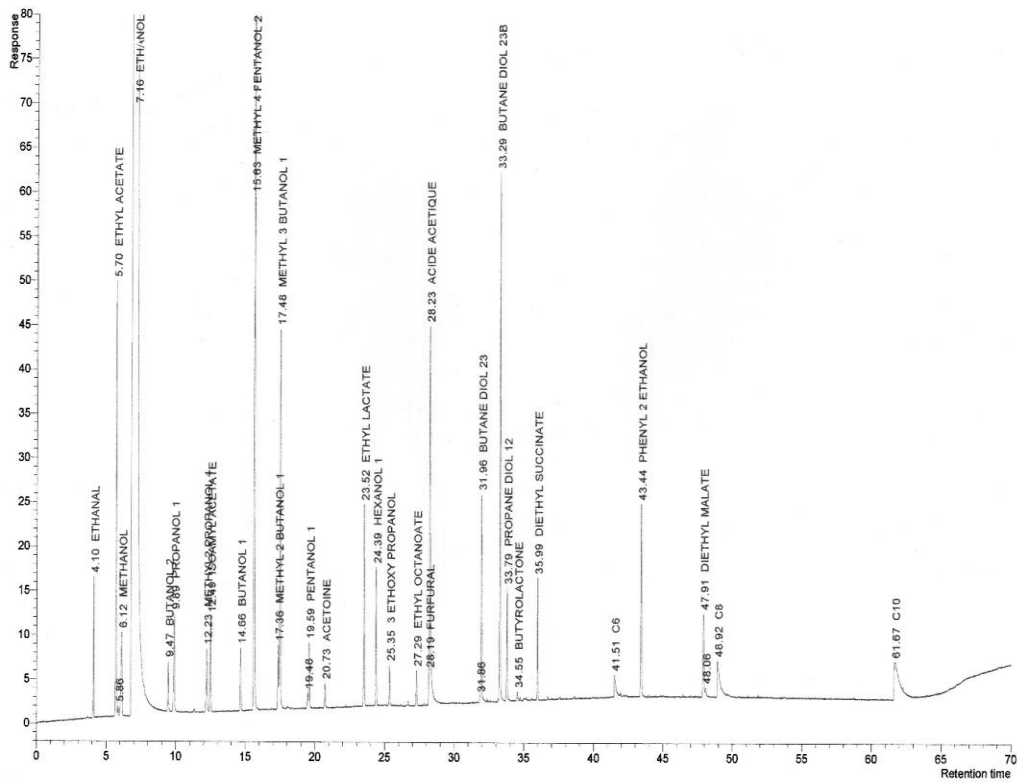

Figure 1: chromatogram of a standard solution of volatile compounds

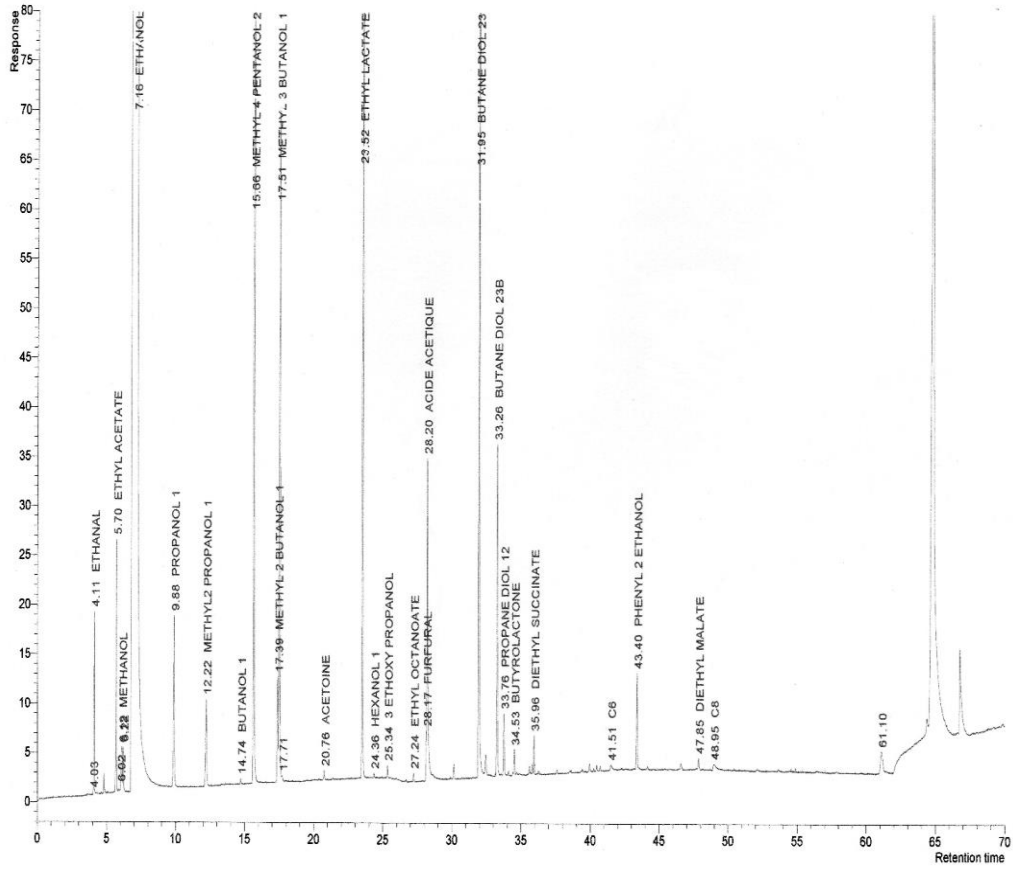

Figure 2 : chromatogram of volatile compounds in a white wine (sugar < 15 g/L)

**Method of determination of 1,2-propanediol
and 2,3-butanediol**

(Resolution OIV-OENO 589/2017)

1. INTRODUCTION

Measurable quantities of 1,2-propanediol and 2,3-butanediol are formed following fermentation processes. These compounds are practically absent in unfermented musts, yet found within certain limits in wines.

2. PRINCIPLE

The analytes and the internal standard are extracted through the use of ethyl ether. Their transfer into the organic phase is facilitated by the increase in the ionic strength of the initial wine or must matrix. A large quantity of K_2CO_3 is added to the samples ('salting out') for this purpose. The extracts are analysed directly via GC-MS on a polar column. The detection is conducted according to the retention time and the mass spectrometer.

3. SCOPE OF APPLICATION

The method is suitable for determining 1,2-propanediol and 2,3-butanediol in musts and wines whose sugar content is greater than 20 g/L and whose analyte concentrations are between 1 mg/L and 500 mg/L.

4. ABBREVIATIONS

C	Concentration
PG	1,2-Propanediol
GC-MS	Gas Chromatograph-Mass Spectrometer
H ₂	Hydrogen
IS	Internal standard 1,3-butanediol
m/z	Mass/charge ratio
RF	Response factor
ML	Matrix calibration level

SS	Stock solution
CS	Calibration solution
RT	Retention time
CS	Calibration solutions for gas chromatography
BG	2,3-Butanediol
S	Wine with a sugar content > 20 g/L
M	Must

5. REAGENTS

- 5.1. K₂CO₃ (CAS no. 584-08-7)
- 5.2. Ethyl ether (CAS no. 60-29-7)
- 5.3. Absolute ethanol (CAS no. 64-17-5)
- 5.4. Fructose (CAS no. 57-48-7)
- 5.5. Glucose (CAS no. 50-99-7)
- 5.6. Glycerol (CAS no. 56-81-5)
- 5.7. 1,2-Propanediol, purity > 99% (CAS no. 57-55-6)
- 5.8. 2,3-Butanediol, purity > 99%, mix of (R,R)- and (R,S)-isomers (CAS no. 513-85-9). Estimate the relative quantity of the (R,R) and (R,S) forms as follows:
 - 5.8.1. prepare a 100 mg/L solution following the instructions in points 7.2.1 and 7.3, diluting the mix of 2,3-butanediol isomers (5.8) in water (5.10) instead of in the matrix model solution;
 - 5.8.2. inject into the GC, under the conditions described in point 7.6, and calculate the percentage of (R,R) and (R,S) forms from the percentage of the areas of the two peaks;
 - 5.8.3. take into consideration the relative quantity of the two forms to calculate the concentration of the calibration solutions, C_{CS,i}, used in paragraph 8.2.1 for the calculation of the RF_i relating to the (R,R) and (R,S) forms.
- 5.9. 1,3-Butanediol, purity > 99%, anhydrous (or dehydrated with sodium sulphate for 24 hours) (CAS no. 107-88-0)
- 5.10. Purified water for laboratory use, certified to the EN ISO 3696 standard
- 5.11. Nitrogen

6. APPARATUS

- 6.1. Everyday laboratory apparatus such as class-A 1000-mL, 200-mL and 100-mL flasks

- 6.2. Analytical scale with an accuracy of $\pm 0,0001$ g
- 6.3. Laboratory centrifuge (at least 4000 rpm or 2000 xg)
Note 1. The unit 'xg' refers to the acceleration experienced by particles in a centrifuge, while 'rpm' represents the number of revolutions the rotor of the centrifuge makes per minute. There is a relationship between these units of measurement:
$$xg = 1.1178 \cdot 10^{-3} \cdot n^2 \cdot r.$$
In the laboratory that developed this method, $r = 0.115$ m.
- 6.4. Chromatograph coupled to a mass spectrometer and split-splitless injector
- 6.5. Precision micropipettes and Pasteur pipettes
- 6.6. 30-mL centrifuge tubes resistant to ether and provided with stoppers
- 6.7. Thermostatically-controlled water bath
- 6.8. Vertical vortex mixer

7. PROCEDURE

7.1. Preparation of the model solutions that simulate the matrix

To obtain a better response to the GC-MS during quantification, different solutions should be prepared that simulate the matrix of the sample in question as much as possible, given that the response to the analysis of glycols varies according to the matrix in which they were diluted.

Table 1: Preparation of the model solutions in 1000-mL calibrated flasks.

	Model solution	
	M	S
Fructose	100 g/L	50 g/L
Glucose	100 g/L	50 g/L
Glycerol	1 g/L	4 g/L
Absolute ethanol	1% v/v	5% v/v

7.2. Preparation of reference solutions

7.2.1. SS: PG and BG stock solutions

With an accuracy of 0.1 mg, weigh about 0.10 g of 1,2-propanediol (PG) and about 0.10 g of 2,3-butanediol (BG) into a 10-mL calibrated flask and fill up to the calibration mark with water (5.10). Make a note of the weights. Hermetically seal the flask and mix. The concentration is

approximately 10 mg/mL in the PG solution and 10 mg/mL in the BG solution.

If the quantities of PG and BG differ by 0.1 g, calculate the exact concentrations based on the weights noted.

7.2.2. IS: IS stock solution

With an accuracy of 0.1 mg, weigh about 0.10 g of 1,3-Butanediol (IS) into a 10-mL calibrated flask and fill up to the calibration mark with water (5.10). Make a note of the weight. Hermetically seal the flask and mix. The concentration of this solution is 10 mg/mL.

If the quantity of IS differs by 0.1 g, calculate the exact concentration based on the weights noted.

7.3. Preparation of the calibration matrix solution

The calibration solutions are prepared as follows, by diluting the SS solution into a model solution whose composition is as close as possible to that of the sample for analysis (for sweet wine, S model solution; for must, M model solution):

Table.2: Preparation of calibration solutions (CS) in 100-mL calibrated flasks:

	CS-M	CS-S
SS Solution	1 mL	1 mL
To reach a final volume of 100 mL, make up to volume with:	M model solution	S model solution

Every CS calibration solution contains the selected matrix and the concentration of PG and BG is 100 mg/L. The internal standard is added before the extraction as described in paragraph 7.5.

7.4. Preparation of samples

If the analyte concentration in the sample is greater than the maximum concentration provided within the scope of application, dilute the sample with the model solution (7.1).

Stir the sample before taking the 10 mL to be extracted.

In the case of musts or cloudy wines, sample the clear wine after filtration.

In the case of sparkling or semi-sparkling wines, carry out degassing as described in the OIV method 'Total Acidity' (OIV-MA-AS313-01, point 5.1).

Proceed with all of the preparation and carry out the tests in duplicate.

7.5. Extraction

7.5.1. Adding the internal standard (IS) to the sample

Prepare a solution containing 5 mL of IS solution (7.2.2) in a 100-mL flask and fill up to the calibration mark with the sample to be analysed, then shake well.

This solution contains 500 mg/L of IS.

7.5.2. Musts and wines with a sugar content > 20 g/L

7.5.2.1. Addition of K₂CO₃

Pour 10 mL of the solution just prepared, composed of the sample to be analysed and the IS solution, into the centrifuge test tube (6.6), then add 10 g of K₂CO₃ (5.1) and wait for it to cool. To speed up cooling you may use a thermostatically-controlled water bath at 20 °C (6.7).

7.5.2.2. Extraction with ether

Once cooled, add 10 mL of ethyl ether (5.2) and shake the whole mixture with a vertical vortex agitator, then put it in the centrifuge (6.3) at about 3500 rpm (or 1500 xg) for 10 minutes.

7.5.3. Purification for GC/MS analysis

The supernatant liquid is collected with a Pasteur pipette, transferred into a suitable flask and the solvent evaporated under a flow of nitrogen. The residue is recovered with about 1 mL of ethyl ether and placed in a tightly sealed GC vial ready for GC/MS analysis.

7.5.4. Extraction of the CS calibration solutions

This procedure must also be carried out for the chosen CS calibration solution (7.3). The CS solutions must be considered as samples to all intents and purposes, and must thus be treated in the same way as the sample starting from the moment the IS is added (7.5.1).

7.6. GC-MS analysis

By way of example, the specific parameters of the GC-MS analysis are given below. Alternative systems may be used, if they give adequate chromatographic performances and make it possible to separate the

chromatographic peaks with a precision of greater than 2.

7.6.1. GC typical conditions

Column: 60 m x 0.25 mm x 0.25 µm DB-WAX

Carrier gas: He

Carrier gas flow: 1.0 mL/min

Injector temperature: 250 °C

Injection volume: 1 µL

Ionising current: 70 eV

Temperature settings:

	Increase (°C/min)	Temperature (°C)	Time (min)
Start		50	8.00
Ramp 1	4.0	220	
Ramp 2		220	40

7.6.2. Specific MS conditions

Source: 230 °C

MS detector: 150 °C scan, 35.00 – 350.00 amu.

Start time: 10 min

Acquisition time for each mass is 250 µs

Acquisition mode: Full Scan

8. EVALUATION

8.1. Identification

Identification is performed by comparing the retention time of the calibration solutions provided for this purpose and the mass spectrum found in the library associated with the GC-MS.

8.2. Calculations

For quantification, $m/z = 45$ is used for the IS, and also the PG and two forms of BG.

8.2.1. Determination of response factors

Quantification is carried out based on the response factor RF obtained by analysing the reference solution:

$$RF_i = \frac{A_{IS}/C_{IS}}{A_{CS,i}/C_{CS,i}}$$

where:

A_{IS} is the peak area of the internal standard and C_{IS} is its concentration;

$A_{CS,i}$ is the peak area of the PG or each of the isomeric forms of BG in the calibration solution and $C_{CS,i}$ is its concentration.

8.2.2. Calculation of the concentrations in the samples

Once the response factor RF has been calculated the calculation of the concentration of PG and each of the isomeric forms of BG in the samples can be performed, according to the following formula:

$$C_i = RF_i \times C_{CS} \times A_i/A_{IS}$$

where:

A_i is the peak area of the PG or the BG in the sample and C_i is its concentration.

8.3. Expression of the results

The results are expressed in mg/L to the nearest whole number.

Express 2,3-butanediol as the sum of (R,R)-2,3-butanediol and (R,S)-2,3-butanediol.

9. BIBLIOGRAPHY

Carsten Fauhl, Reiner Wittkowski, Janice Lofthouse, Simon Hird, Paul Brereton, Giuseppe Versini, Michele Lees and Claude Guillou, 'Gas Chromatographic/Mass Spectrometric Determination of 3-Methoxy-1,2-Propanediol and Cyclic Diglycerols, By-Products of Technical Glycerol, in Wine: Interlaboratory Study', *JOURNAL OF AOAC INTERNATIONAL*, VOL. 87, NO. 5, 2004.

Di Stefano, R., García Moruno, E. and Borsa, D., 'Proposta di un metodo di preparazione del campione per la determinazione dei glicoli dei vini', *VINI D'ITALIA*, 4, 1992, pp. 61-64.

García Moruno, E. and Di Stefano, R., 'La determinazione del glicerolo, del 2,3-butanediolo e dei glicoli nei vini', *VINI D'ITALIA*, 5, 1989, pp. 41-46.

Di Stefano, R., Borsa, D. and García Moruno, E., 'Glicoli naturalmente presenti nei vini', *VINI D'ITALIA*, 5, 1988, pp. 39-44.

ANNEX 1

METHOD PERFORMANCE

1. Linearity

Verification of the linearity of the response for a 200 g/L sugar solution (100 g/L of glucose and 100 g/L of fructose). Each analyte was added at concentrations of 10, 100 and 500 mg/L, while the IS was added at a concentration of around 100 mg/L. The measurements were repeated three times.

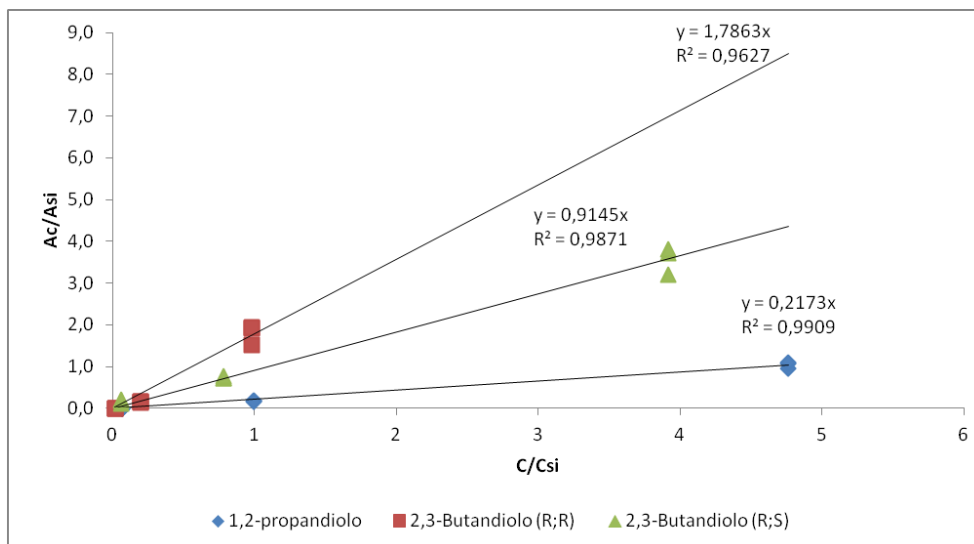

The mean response factors are:

1,2-Propanediol	$RF = (C/C_{IS})/(A/A_{IS}) = 1/0.2173 = 4.60$
(R,R)-2,3-Butanediol	$RF = (C/C_{IS})/(A/A_{IS}) = 1/1.7863 = 0.56$
(R,S)-2,3-Butanediol	$RF = (C/C_{IS})/(A/A_{IS}) = 1/0.9145 = 1.09$

2. Repeatability

The repeatability was evaluated for two must samples.

One was analysed as such (Must N°1) and the other was obtained by adding 100 mg/L of SS stock solution to it (Must N°2).

The following table makes reference to 10 repeated analyses, and the repeatability (r) is calculated according to the formula $r = 2.8 * Sr$. (Sr = repeatability standard deviation, RSDr = relative standard deviation of repeatability).

Compound	Must N°1				Must N°2			
	Mean (mg/ L)	Sr (mg/ L)	RSD r (%)	r (mg/ L)	Mean (mg/ L)	Sr (mg/ L)	RS Dr (%)	r (mg/L)
1,2-Propanediol	1.5	0.5	36	1.5	107	9	9	30
(R,R)-2,3- Butanediol	3.2	1.6	52	4.6	30	3	9	9.0
(R,S)-2,3- Butanediol	5.4	1.7	33	4.9	104	11	10	34

Evaluation of the precision of the limit of repeatability according to the Horwitz equation and Horrat parameter (r):

RECUEIL INTERNATIONAL DES METHODES D'ANALYSES – OIV
Method of determination of 1,2-propanediol and 2,3-butanediol

Must no. 1

	Mean (mg/L)	C·10 ⁶ (m/m)	PRSD (R)	R Horwitz	Horrat (r)	r min H	r max H
1,2- Propanediol	1.5	1.5	15	0.6	2.40	0.2	0.8
(R,R)-2,3- Butanediol	3.2	3.2	13	1.2	3.87	0.3	1.6
(R,S)-2,3- Butanediol	5.4	5.4	12	1.9	2.64	0.5	2.5

The limit of repeatability 'r' is not contained within the validation range specified by the Horwitz equation ($r_{\min H} < r < r_{\max H}$) due to the greater volatility of low-concentration measurements, close to the limit of quantification established in paragraph 5 of Annex 1.

Must no.2

	Mean (mg/L)	C·10 ⁵ (m/m)	PRSD (R)	R Horwitz	Horrat (r)	r min H	r max H
1,2- Propanediol	107	11	7.9	24	1.09	5.9	31.8
(R,R)-2,3- Butanediol	30	3	9.5	8	0.98	2.0	10.7
(R,S)-2,3- Butanediol	104	10	7.9	23	1.29	5.7	30.8

The limit of repeatability 'r' is not contained within the validation range specified by the Horwitz equation ($r_{\min H} < r < r_{\max H}$).

3. Recovery rate

The recovery rate was evaluated for must N°2 before and after addition of the SS stock solution, as described in paragraph 7.3 of the method.

RECUEIL INTERNATIONAL DES METHODES D'ANALYSES – OIV
Method of determination of 1,2-propanediol and 2,3-butanediol

Compound	C. in the must (mg/L)	C. added (mg/L)	Theoretical C. (mg/L)	Measured C. (mg/L)	Recovery rate (%)
1,2-Propanediol	0.7	99.5	100.2	107.5	107
(R,R)-2,3-Butanediol	12.6	21.7	34.3	29.9	87
(R,S)-2,3-Butanediol	11.4	86.8	98.2	103.7	106
<i>(R,R)- + (R,S)-2,3-Butanediol</i>	<i>24.0</i>	<i>108.5</i>	<i>132.5</i>	<i>133.6</i>	<i>101</i>

The recovery rate is satisfactory for 1,2-propanediol and for 2,3-butanediol evaluated overall as the sum of both forms.

4. Effect of the sugar matrix on the response factors

The RFs obtained for the equimolar glucose and fructose solutions with total sugar concentrations of 200 g/L and 2 g/L were compared.

	1,2-Propanediol		(R,R)-2,3-Butanediol		(R,S)-2,3-Butanediol	
Sugars	200 g/L	2 g/L	200 g/L	2 g/L	200 g/L	2 g/L
RF	4.60	5.90	0.55	0.56	1.08	1.09
ΔRF %	22.0 %		1.8 %		0.9 %	

The effect of the matrix on 1,2-Propanediol is highly marked, while it is negligible for both forms of 2,3-Butanediol.

5. Limit of detection and limit of quantification

The limit of detection (LOD) and limit of quantification (LOQ) depend on specific analytical-chemical measurement conditions and should be determined by all those who use the method.

The limit of detection (LOD) and limit of quantification (LOQ) were evaluated using the above-mentioned equipment and conditions (point 8) and by following the instructions of Resolution OENO 7-2000 (OIV-MA-AS1-10) 'Estimation of the detection and quantification limits of a method of analysis' as described in paragraph 4.2 concerning the "Graph" Approach.

RECUEIL INTERNATIONAL DES METHODES D'ANALYSES – OIV
Method of determination of 1,2-propanediol and 2,3-butanediol

	1,2-Propanediol	(R,R)-2,3-Butanediol	(R,S)-2,3-Butanediol
LOD (mg/L)	0.2	0.2	0.2
LOQ (mg/L)	0.6	0.7	0.8

Annex 2

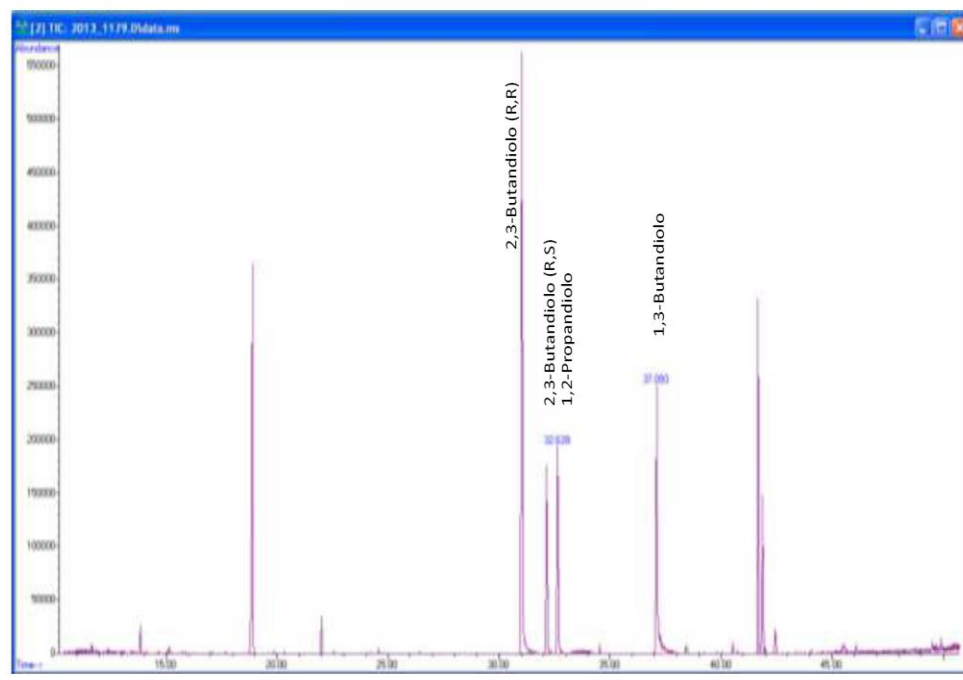

FIG. 1 Chromatogram of a wine.

Detection of chitinase and thaumatin-like
proteins in white wines

(Resolution OIV-OENO 529/2017)

1. Introduction

For the detection of unstable proteins and risks of protein *cassee* in white wines, many tests are heat- or precipitation-based, the latter using a chemical agent. These tests give very different, unreliable and even contradictory results. This immunological method of semi-quantitative immunoprinting makes it possible to determine the presence or absence of unstable proteins in wines. Therefore, chitinase and thaumatin-like proteins can be detected from a total concentration of as low as 1 mg/L in wines. This value is taken from the comparison of results with the SDS electrophoresis method described in the *Compendium of Methods of Analysis* (OIV-MAA-AS315-12), for which the limit of detection is 1 mg/L.

2. Scope of application

This immunological method of immunoprinting applies to white wines.

3. Principle

The immunological method of immunoprinting is conducted in 3 steps:

- 3.1 Application of the wine sample to a nitrocellulose membrane
- 3.2 Detection of unstable proteins
- 3.3 Revelation of the presence of unstable proteins

The intensity of the coloured spots observed on the membrane is proportional to the quantity of unstable proteins and to the risk of protein *cassee* in wine.

4. Reagents and products

- 4.1 List of reagents and products

RECUEIL INTERNATIONAL DES METHODES D'ANALYSES – OIV
Detection of chitinase and thaumatin-like
proteins in white wines

Unless otherwise indicated, use the products as marketed.

- 4.1.1 Ultra-pure water: resistivity $\geq 18 \text{ M}\Omega\cdot\text{cm}$ at 25 °C
- 4.1.2 A wine very rich in proteins and a wine containing no proteins following treatment with bentonite. These wines are used for the positive and negative controls respectively: verification and quantification of proteins present in these wines may be conducted using SDS-PAGE electrophoresis (Method OIV-MA-AS315-12)
- 4.1.3 Rabbit polyclonal antibodies directed against unstable proteins in wine: see the protocol in the Annex
- 4.1.4 Goat anti-rabbit IgA polyclonal antibodies conjugated to horseradish peroxidase (hereinafter referred to as: goat anti-rabbit-HRP antibodies)
- 4.1.5 Anhydrous sodium chloride (NaCl): CAS No. 7647-14-5
- 4.1.6 Anhydrous Tris-HCl: CAS No. 1185-53-1
- 4.1.7 Concentrated HCl in solution; purity $\geq 36.5\%$: CAS No. 7647-01-0
- 4.1.8 Tween 20: CAS No. 9005-64-5
- 4.1.9 Lyophilised Bovine Serum Albumin (BSA) powder; purity $\geq 96\%$: CAS No. 9048-46-8
- 4.1.10 4-Chloro-1-naphthol; purity $\geq 99\%$: CAS No. 604-44-4
- 4.1.11 Methanol; purity $\geq 99.8\%$: CAS No. 67-56-1
- 4.1.12 Hydrogen peroxide in solution (H_2O_2); purity $\geq 30\%$: CAS No. 7722-84-1

4.2 Preparation of working solutions

All of the solutions may be stored for 1 year at 4 °C.

4.2.1 TBS buffer (tris-buffered saline)

Dissolve 29.22 g of sodium chloride (4.1.5) and 2.42 g of anhydrous Tris-HCl (4.1.6) in 1 litre of ultra-pure water (4.1.1). Adjust the pH to 7.5 using a concentrated HCl solution (4.1.7).

4.2.2 TBS-Tween 20 buffer

RECUEIL INTERNATIONAL DES METHODES D'ANALYSES – OIV
Detection of chitinase and thaumatin-like
proteins in white wines

Add 0.05% of Tween 20 (4.1.8) to the TBS buffer (4.2.1).

4.2.3 Blocking solution

Add 4% of BSA (4.1.9) to the TBS buffer (4.2.1).

4.2.4 Polyclonal antibody solution (available on the market or according to the protocol described in the Annex)

4.2.4.1 Dilute the unstable anti-protein polyclonal antibodies (primaries) according to commercial recommendations or to their concentrations in the TBS buffer (4.2.1).

4.2.4.2 Dilute the goat anti-rabbit-HRP polyclonal antibodies (secondaries) according to commercial recommendations or to their concentrations in the TBS buffer (4.2.1).

4.2.5 Solutions for revelation of unstable proteins

4.2.5.1 Dissolve 30 mg of 4-chloro-1-naphthol (4.1.10) in 10 mL of methanol (4.1.11). Place this solution in the dark at -20 °C until needed.

4.2.5.2 Add 30 µL of 30% H₂O₂ (4.1.12) to 50 mL of TBS (4.2.1) just before use.

5. Materials

5.1 List of materials for the immunoprinting reaction:

- 5.1.1 nitrocellulose membrane with 0.2 µm pores for conducting immunoprinting;
- 5.1.2 0.5-10 µL and 100-1000 µL automatic pipettes, corresponding cone filters;
- 5.1.3 tubes, tube rack for dilutions of antibodies;
- 5.1.4 class-A graduated cylinders;
- 5.1.5 absorbent paper;
- 5.1.6 tweezers;
- 5.1.7 laboratory glassware to carry out the reaction: small crystalliser, Petri dish, tubes, stoppers, etc.;
- 5.1.8 platform shaker (for a reaction in a dish) or vortex mixer (for a reaction in a tube) with a maximum speed of 20 RPM.

RECUEIL INTERNATIONAL DES METHODES D'ANALYSES – OIV
Detection of chitinase and thaumatin-like
proteins in white wines

5.2 Equipment required to prepare the solutions:

- 5.2.1 class-A calibrated flasks;
- 5.2.2 pH meter;
- 5.2.3 precision weighing balance with an accuracy of 0.1 mg;
- 5.2.4 3000-g centrifuge and centrifuge tubes.

6. Sampling

The samples should be taken and stored at 4 °C so as not to modify the proteins naturally present in the wine.

6.1 Sample preparation

The samples (or laboratory samples) of wines are applied directly to the nitrocellulose membrane (5.1.1) using the pipette (5.1.2), without prior preparation.

7. Procedure

Analysis may be conducted on unfiltered wines on the sole condition that these wines do not contain bentonite in suspension. If this is the case, carry out centrifugation at 3000 g (5.2.4) for 10 min at room temperature.

As indicated in point 3, the immunological method of immunoprinting takes place in 3 steps, and the reactions are conducted at a room temperature of between 18 °C and 25 °C.

7.1 Application of the wine sample

Apply 5 µL (5.1.2) of test portion from the samples and standard colorimetric solutions to the nitrocellulose membrane (5.1.1).

Leave to dry for 15-20 min at room temperature.

7.2 Addition of monoclonal antibodies

7.2.1 Place the membrane in the dish or tube (5.1.7). The volume of the solutions will be dependent on the container and the size of the membrane. This membrane should be covered.

RECUEIL INTERNATIONAL DES METHODES D'ANALYSES – OIV
Detection of chitinase and thaumatin-like
proteins in white wines

The volumes specified below are for a small Petri dish-type container (5.1.7).
Add the blocking solution (4.2.3). Mix for at least 30 minutes (5.1.8).

7.2.2 Wash by draining off the solution, holding down the membrane if necessary with tweezers, before adding 20 mL of TBS (4.2.1) and mixing for several minutes (5.1.8).

Wash a second time as described above and drain off the solution.

7.2.3 Add 20 mL of primary antibody solution (4.2.4.1).
Mix for one hour (5.1.8).

Wash 3 times with the TBS-Tween 20 solution (4.2.2).

7.2.4 Add 20 mL of goat anti-rabbit-HRP secondary antibody solution (4.2.4.2).
Mix for one hour.

7.2.5 Wash with the TBS-Tween 20 solution (4.2.2) as described above for 5 min.
Wash 2 times with the TBS solution (4.2.1) as described above for 15 min.
Drain off the solution.

7.3 Revelation of the presence of unstable proteins

7.3.1 Mix the two solutions to reveal the unstable proteins (4.2.5.1 and 4.2.5.2) and place in contact with the membrane (5.1.1) prepared according to protocols 7.1 and 7.2, to which the wine has been applied, and stir.

A black-dark purple to mauve precipitate appears on the membrane where the unstable proteins are present.

The colour intensity is dependent upon the concentration of unstable proteins and therefore the risk of protein *cassee*.

After 20-30 min, when the spot corresponding with the application of the positive standard colorimetric solution (4.1.2) is very intense, stop the colouration by washing the nitrocellulose membrane (5.1.1) in water.

Place the membrane to be dried between 2 sheets of absorbent paper (5.1.5).

The results can be interpreted when the membrane is dry.

8. Results

For the results to be interpretable:

RECUEIL INTERNATIONAL DES METHODES D'ANALYSES – OIV
Detection of chitinase and thaumatin-like
proteins in white wines

- the place of application of the positive standard colorimetric solution should show a spot of high colour intensity (dark purple-black),
- the place of application of the negative standard colorimetric solution should show no spots,
- the background "noise" (place on the membrane where no sample has been applied) should be very light, even white.

A semi-quantitative result may be obtained by making a calibration curve based on a wine naturally rich in proteins, for which a dilution range will be used. This calibration curve will be dependent on the surface areas obtained through integration of the colour intensity of the spots corresponding to the formation of immunocomplexes. Analysis may be carried out with the same equipment as that used to analyse the electrophoresis gels described in the Method OIV-MA-AS315-12.

Interpretation of the results may also be carried out visually.

8.1 For direct control over the presence or absence of unstable proteins in wine

Proteins are present in the laboratory sample if the colour intensity of the spot obtained is higher than that of the spot for the negative standard colorimetric solution.

The colour intensity of the spot obtained after the reaction is proportional to the quantity of unstable proteins and, consequently, proportional to the risk of protein *cassee* in this wine.

8.2 To verify the absence of proteins after treatment (in particular, with bentonite)

Proteins are present in the sample if the colour intensity of the spot obtained for the test portion without bentonite treatment is higher than that of the spot for the negative standard colorimetric solution.

In the case of application of a "range of treatment products (bentonite)" in a laboratory test, the colour intensity of the spots in each test portion should decrease as the treatment product concentration increases. Where this intensity is null or minimal for one spot but consistent in relation to the other samples in the range, the dose of the treatment product corresponding to the spot in question is applied to achieve protein stability in the tested wine.

9. Annexes

Production of polyclonal antibodies directed against unstable proteins

The antibodies directed against unstable proteins in white and rosé wines may be prepared in rabbits. It is their specificity which makes the method reliable and precise.

9.1 Purification of Chitinase and Thaumatin-like proteins

9.1.1 List of products and equipment

- 9.1.1.1 Ultra-pure water: resistivity $\geq 18 \text{ M}\Omega\cdot\text{cm}$
- 9.1.1.2 Wine grape harvested at technological maturity (Chardonnay or Sauvignon blanc vine variety, for example)
- 9.1.1.3 Anhydrous sodium acetate: CAS No. 127-09-3
- 9.1.1.4 Triton X-100: CAS No. 9002-93-1
- 9.1.1.5 Anhydrous ammonium sulphate: CAS No. 127-09-3
- 9.1.1.6 Anhydrous sodium chloride (NaCl): CAS No. 7647-14-5
- 9.1.1.7 Anhydrous Tris-HCl: CAS No. 1185-53-1
- 9.1.1.8 37% Pure hydrochloric acid: CAS No. 7647-01-0
- 9.1.1.9 1M NaOH sodium hydroxide solution: CAS No. 1310-73-2
- 9.1.1.10 Laboratory glassware, including Class-A calibrated flasks and pipettes
- 9.1.1.11 Tweezers
- 9.1.1.12 10,000-g Centrifuge
- 9.1.1.13 Laboratory weighing balance with an accuracy of 0.1 mg
- 9.1.1.14 pH meter
- 9.1.1.15 Strong anionic resin
- 9.1.1.16 Anionic resin
- 9.1.1.17 Membrane with cut off of 10 kDa
- 9.1.1.18 Low-pressure liquid chromatography apparatus with concentration-gradient pump
- 9.1.1.19 Detector measuring the absorbance at $\lambda 280 \text{ nm}$
- 9.1.1.20 Conductivity detector

RECUEIL INTERNATIONAL DES METHODES D'ANALYSES – OIV
Detection of chitinase and thaumatin-like
proteins in white wines

9.1.2 Preparation of sodium acetate buffer (9.1.1.3) diluted to 50 mM, 0.25% Triton X-100 (9.1.1.4) at pH 5

Place the following successively in a 1-L calibrated flask (9.1.1.10):

- 4.1 g sodium acetate (9.1.1.3),
- 2.5 g Triton X-100 (9.1.1.4),
- make up to 1 L with ultra-pure water (9.1.1.1) and stir; adjust the pH to 5 using 37% HCl (9.1.1.8) in order to avoid having a basic environment that could have a harmful effect on the proteins to be extracted or impede their extraction.

9.1.3 Preparation of the 50-mM Tris-HCl buffer, pH 8.0

Place the following successively in a 1-L calibrated flask (9.1.1.10):

- 7.9 g anhydrous Tris-HCl (9.1.1.7)
- Make up to 1 L with ultra-pure water (9.1.1.1); adjust the pH to 8 using a 1M NaOH solution (9.1.1.9).

9.1.4 Preparation of the 50 mM Tris-HCl buffer, 100 mM NaCl

Place the following successively in a 1-L calibrated flask (9.1.1.10):

- 7.9 g anhydrous Tris-HCl (9.1.1.7),
- 5.8 g anhydrous sodium chloride (9.1.1.6),
- make up to 1 L with ultra-pure water (9.1.1.1) and mix.

9.1.5 Preparation of 100 mM sodium chloride solution

-Place the following successively in 1-L calibrated flask (9.1.1.10)

- 5.8 g anhydrous sodium chloride (9.1.1.6),
- make up to 1 L with ultra-pure water (9.1.1.1) and mix.

9.2 Procedure

Grapes from the Pinot noir or Chardonnay vine varieties are harvested at maturity and frozen at -20 °C. The seeds are removed from the frozen grapes before crushing. 3 g of seeded grapes are crushed into 10 mL of sodium acetate buffer (9.1.2), diluted to 50 mM, pH 5, containing 0.25% Triton X-100 (9.1.1.4). The insoluble material is removed by centrifugation (5 min at 3000 g) (9.1.1.12). The supernatant (2 mL) is then frozen overnight at -20 °C for clarification purposes.

RECUEIL INTERNATIONAL DES METHODES D'ANALYSES – OIV
Detection of chitinase and thaumatin-like
proteins in white wines

The extract is then centrifuged at 10,000 g for 15 min to remove the insoluble material.

Ammonium sulphate (9.1.1.5) is added to the supernatant up to a concentration of 30%. The mixture is mixed for 1 hour at 4 °C then centrifuged once more as described above.

Ammonium sulphate (9.1.1.5) is again added to the supernatant up to a final concentration of 60%. The mixture is mixed for 2 hours at 4 °C then centrifuged once more as described above.

The protein precipitate is collected then re-dissolved in 1 mL of 50 mM Tris-HCl buffer, pH 8.0 (9.1.3). The proteins are bound to a column containing a strong anionic resin (5 x 30 cm) (9.1.1.15). The column is washed with the Tris-HCl buffer described above. Chitinase and Thaumatin-like proteins are then extracted using a Tris-HCl buffer containing 100 mM NaCl. All the fractions are collected then desalinated on a membrane with a MWCO of 10 kDa (9.1.1.17) using the 50 mM Tris-HCl buffer, pH 8.0 (9.1.4.3). The desalinated protein fractions are then loaded onto a low-pressure chromatography column (9.1.1.18) containing an anionic resin (9.1.1.16). Elution is carried out with 120 mL of a NaCl (9.1.5) gradient ranging from 0 to 100 mM by means of a concentration-gradient pump using a solution A of ultra-pure water (9.1.1.1) and a solution B of sodium chloride, 100 mM (9.1.5). The protein and salt concentrations are estimated respectively by measuring the absorbance at 280 nm and the conductivity of the fluids exiting the column using detectors (9.1.1.19 and 9.1.1.20). The Chitinase and Thaumatin-like protein fractions thus purified and separated are used for the production of antibodies.

9.3 Production of anti-Chitinase and Thaumatin-like polyclonal antibodies in rabbits

The protocol used is identical to that described in the Method OIV-MA-AS315-12.

10. Bibliography

1. **Anonymous.** 2004. "Determination of Plant Proteins in Wines and Musts," OIV, *Resolution Oeno 24/2004*. 1-7. (Method OIV-MA-AS315-12).

RECUEIL INTERNATIONAL DES METHODES D'ANALYSES – OIV
Detection of chitinase and thaumatin-like
proteins in white wines

2. **Derckel, J. P.; Audran, J. C.; Haye, B.; Lambert, B. and Legendre, L.** 1998. "Characterization, Induction by Wounding and Salicylic Acid, and Activity against *Botrytis cinerea* of Chitinases and Beta-1,3-Glucanases of Ripening Grape Berries." *Physiologia Plantarum*, 104 (1), 56-64.
3. **Manteau, S.; Lambert, B.; Jeandet, P. and Legendre, L.** 2003. "Changes in Chitinase and Thaumatin-Like Pathogenesis-Related Proteins of Grape Berries During the Champagne Winemaking Process." *American Journal of Enology and Viticulture*, 54 (4), 267-72.
4. **Manteau, S. and Poinsaut, P.** 2010. "Instabilité Protéique Des Vins Blancs Et Rosés. Partie 2/2: Comparaison Des Tests De Stabilité Protéique Dans Les Vins Blancs Et Rosés Et Mise Au Point D'un Nouveau Test: L'immunoTest[®]." *Revue des Œnologues*, 135, 23-27.
5. **Manteau, S.; Sauvage, F.-X.; Poinsaut, P.; Scotti, B.; Sieczkowski, N. and Moutounet, M.** 2006. "Haze in White Wine: Involvement of Proteins Other Than Pathogenesis-Related Proteins in Spontaneous Haze," Eds. P. Jeandet, C. Clement and A. Conreux, *Macrowine: Macromolecules and Secondary Metabolites of Grape and Wine*. Reims: Intercept Publishers - Lavoisier, 165-68.
6. **Ribéreau-Gayon, J. and Peynaud, E.** 1961. "Précipitation Des Protéines," *Traité d'Oenologie. Tome II - Composition, Transformations Et Traitements Des Vins*. Librairie Polytechnique Ch. Béranger, 346-356.
7. **Waters, E.; Hayasaka, Y.; Tattersall, D.; Adams, K. and Williams, P.** 1998. "Sequence Analysis of Grape (*Vitis Vinifera*) Berry Chitinases That Cause Haze Formation in Wines." *Journal of Agricultural and Food Chemistry*, 46 (12), 4950-57.

Method OIV-MA-AS315-30

Type IV method

**Determination of alkylphenols in wines by gas
chromatography-mass spectrometry (GC-MS or GC-
MS/MS)**

(Resolution Oeno 620/2020)

1. Scope of application

The following method allows for the determination of the following molecules:

	Range studied
• 2-tert-butylphenol	1-100 µg/L
• 4-tert-butylphenol	1-100 µg/L
• 6-methyl-2-tert-butylphenol	1-100 µg/L
• 4-methyl-2-tert-butylphenol	1-100 µg/L
• 5-methyl-2-tert-butylphenol	1-100 µg/L
• 4,6-di-methyl-2-tert-butylphenol	1-100 µg/L
• 2,6-di-tert-butylphenol	1-100 µg/L
• 2,4-di-tert-butylphenol	1-100 µg/L

2. Standard references

- ISO 78-2: Chemistry – Layouts for standards,
- ISO 3696: Water for analytical laboratory use,
- Resolution OIV-OENO 418-2013.

3. Principle of the method

The method describes the analysis, on the one hand, by gas chromatography coupled with mass spectrometry (GC-MS), and on the other, by gas chromatography coupled with tandem mass spectrometry (GC-MS/MS). The sample is extracted in the headspace using the solid-phase microextraction (SPME) technique.

4. Reagents and working solutions

During analysis – unless otherwise indicated – only quality, recognised analytical reagents and distilled or demineralised water, or water of equivalent purity, are to be used.

4.1. Reagents

- 4.1.1. Quality I or II water for analytical usage (ISO 3696 standard)
- 4.1.2. Absolute ethanol (CAS No. 64-17-5)
- 4.1.3. Sodium chloride (CAS No. 7647-14-5)
- 4.1.4. 4-tert-butylphenol-d13 (CAS 225386-58-3)
- 4.1.5. 4-tert-butylphenol (CAS No. 98-54-4)
- 4.1.6. 2-tert-butylphenol (CAS No. 88-18-6)
- 4.1.7. 4-methyl-2-tert-butylphenol (CAS No. 2409-55-4)
- 4.1.8. 5-methyl-2-tert-butylphenol (CAS No. 88-60-8)
- 4.1.9. 6-methyl-2-tert-butylphenol (CAS No. 2219-82-1)
- 4.1.10. 4,6-di-methyl-2-tert-butylphenol (CAS No. 1879-09-0)
- 4.1.11. 2,4-di-tert-butylphenol (CAS No. 96-76-4)
- 4.1.12. 2,6-di-tert-butylphenol (CAS No. 128-39-2)

4.2. Stock solutions

Individual stock solutions at 1 g/L are prepared in ethanol for each alkylphenol as well as for the internal standard (e.g. 4-tert-butylphenol-d13).

Based on the individual stock solutions, working solutions are prepared in ethanol to the desired concentrations so as to cover the whole measurement range.

4.3 Calibration solutions

In order to ensure the best possible traceability to the International System of Units (SI), the calibration range should be made up of solutions and powders with (a high grade of) purity of different alkylphenols, prepared by weight or volumetrically according to the SI.

The calibration range is carried out with 12% (v/v) ethanol (4.1.2), with the range of measurement (1-100 $\mu\text{g}\cdot\text{L}^{-1}$) covering 5 points, for example. These solutions are prepared at the time of analysis for immediate use after preparation (within a few hours).

The calibration equation obtained is generally a quadratic function.

5. Apparatus

- 5.1. GC-MS equipped with a “split-splitless” injector and mass-spectrometer detector or tandem mass spectrometer
- 5.2. Capillary column with apolar stationary phase, 5% phenylmethylpolysiloxane (e.g. 5MS, 30 m x 0.25 mm x 0.25 µm film) or equivalent
- 5.3. Calibrated 100-µL, 1-mL and 10-mL micropipettes
- 5.4. 20-mL SMPE vial, sealable by a perforated cap and Teflon seal
- 5.5. Solid-phase microextraction system (SPME) with polydimethylsiloxane-film-coated fibre of 100 µm in thickness, or equivalent
- 5.6. Balance
With traceability to the SI and 0.1 mg precision.
- 5.7. Measuring glassware

The measuring glassware for the preparation of reagents and calibration solutions is class A.

6. Preparation of samples

The internal standard 4-tert-butylphenol-d13 is used here by way of example; it is possible to use other internal standards.

A sample of 10 mL wine is placed in a 20-mL SPME glass vial (5.4) with roughly 2 g NaCl (4.1.3) and 50 µL 4-tert-butylphenol-d13 (internal standard) solution at 5 mg/L (4.1.4).

The vial is closed with a perforated cap and Teflon seal (5.4).

7. GC-MS Procedure

The procedure is given by way of example. The GC-MS technique used allows for the necessary variations or optimisations to be made according to the equipment configuration.

7.1. Extraction

The headspace SPME extraction is carried out for 20 minutes at 40 °C.

7.2. Injection

Desorption from the fibre is carried out for 10 minutes in the injector.

Injector at 260 °C in splitless mode

Helium flow rate: 1 mL/min

7.3 Gas chromatography parameters

Column: 5MS UI 30 m x 0.25 mm x 0.25 µm

Transfer line temperature: 300 °C

Oven: 50 °C

Then 10 °C/min up to 300 °C

Then 300 °C for 3 minutes

Run time: 28.0 minutes

7.4 Acquisition

Source temperature: 250 °C

Quad temperature: 150 °C

COMPENDIUM OF INTERNATIONAL ANALYSIS OF METHODS - OIV
Determination of alkylphenols in wines by gas chromatography-
mass spectrometry (GC-MS or GC-MS/MS)

Acquisition: SIM

	Run time (min)	Ions (quantified)	Ions (qualified)
2-tert-butylphenol	8.9	135	107-150
4-tert-butylphenol-d13 (IS)	9.1	145	113-163
4-tert-butylphenol	9.2	135	107-150
6-methyl-2-tert-butylphenol	9.4	149	164-121
4-methyl-2-tert-butylphenol	10.0	149	164-121
5-methyl-2-tert-butylphenol	10.2	149	164-121
4,6-dimethyl-2-tert-butylphenol	10.5	163	135-178
2,6-di-tert-butylphenol	11.2	191	206-192
2,4-di-tert-butylphenol	12.0	191	206-192

Table 1: Ions used in mass spectrometry.

8. GC-MS/MS procedure

The procedure is given by way of example. The GC-MS/MS technique used allows for the necessary variations or optimisations to be made according to the equipment configuration.

8.1. Extraction

The headspace SPME extraction is carried out for 5 minutes at 40 °C.

8.2. Injection

Desorption from the fibre is carried out for 8 minutes in the injector.

Injector at 250 °C in pulsed-split mode with a split ratio of 2:1

Helium flow rate: 2 mL/min

8.3. Gas chromatography parameters

Column: 5MS UI 30 mx0.25 mm x 0.25 µm or equivalent

Transfer line: 300 °C

Oven: 50 °C

Then 25 °C/min up to 130 °C

Then 10 °C/min up to 170 °C

Then 25 °C/min up to 300 °C

Then 300 °C for 3 minutes

Run time: 15.4 minutes

8.4. Acquisition

Source temperature: 250 °C

Quad temperature: 150 °C

Acquisition: MRM

	Run time (min)	Quantification transitions	Qualification transitions
2-tert-butylphenol	5.0	135>107	150>107 & 150>135
4-tert-butylphenol-d13 (IS)	5.1	145>113	163>113 & 163>145
4-tert-butylphenol	5.2	135>107	150>107 & 150>135
6-methyl-2-tert-butylphenol	5.3	149>121	164>121 & 164>149
4-methyl-2-tert-butylphenol	5.7	149>121	164>121 & 164>149

COMPENDIUM OF INTERNATIONAL ANALYSIS OF METHODS - OIV
Determination of alkylphenols in wines by gas chromatography-
mass spectrometry (GC-MS or GC-MS/MS)

5-methyl-2-tert-butylphenol	5.8	149>121	164>121 & 164>149
4,6-dimethyl-2-tert-butylphenol	6.1	163>135	178>135 & 178>163
2,6-di-tert-butylphenol	6.6	206>191	191>163 & 191>57
2,4-di-tert-butylphenol	7.2	191>57	191>163 & 206>191

Table 2: Ions used in tandem mass spectrometry.

9. Expression of results

The results are expressed in µg/L.

COMPENDIUM OF INTERNATIONAL ANALYSIS OF METHODS - OIV
Determination of alkylphenols in wines by gas chromatography-
mass spectrometry (GC-MS or GC-MS/MS)

10. Annex 1: Results of internal validation

The performance was measured using an intra-laboratory experimental approach: 5 materials covering the scope of application of the method (1; 5; 25; 50; 100 µg/L) were formulated, within a synthetic wine matrix (hydroalcoholic solution at 12% (v/v), 6 g/L tartaric acid, pH adjustment to 3.5 with 1M NaOH).

Each material was analysed 5 times under conditions of intermediate precision with 2 repetitions of each analysis. The analyses were performed in September and October 2018.

The calculations were made according to Resolution OIV-OENO 418-2013, “Practical Guide for the assessment, quality control, and uncertainty analysis of an oenological analysis method”.

GC-MS	% CV (k=2) Intermediate precision	CV_r (%) Repeatability	Validated LOQ
2-tert-butylphenol	6.7%	4.3%	1 µg/L
4-tert-butylphenol	7.3%	5.1%	1 µg/L
6-methyl-2-tert-butylphenol	12.1%	10.2%	1 µg/L
4-methyl-2-tert-butylphenol	6.0%	4.6%	1 µg/L
5-methyl-2-tert-butylphenol	6.4%	4.9%	1 µg/L
4,6-dimethyl-2-tert-butylphenol	12.7%	10.5%	1 µg/L
2,6-di-tert-butylphenol	19.5%	14.6%	1 µg/L
2,4-di-tert-butylphenol	11.9%	9.9%	1 µg/L

Table 3: Performance obtained with mass spectrometry.

COMPENDIUM OF INTERNATIONAL ANALYSIS OF METHODS - OIV
Determination of alkylphenols in wines by gas chromatography-
mass spectrometry (GC-MS or GC-MS/MS)

GC-MS/MS	% CV (k=2) Intermediate precision	CV _r (%) Repeatability	LOQ
2-tert-butylphenol	11.3%	10.1%	1 µg/L
4-tert-butylphenol	10.4%	11.0%	1 µg/L
6-methyl-2-tert-butylphenol	13.9%	13.5%	1 µg/L
4-methyl-2-tert-butylphenol	11.1%	9.6%	1 µg/L
5-methyl-2-tert-butylphenol	12.3%	10.3%	1 µg/L
4,6-dimethyl-2-tert-butylphenol	13.4%	12.6%	1 µg/L
2,6-di-tert-butylphenol	16.6%	16.8%	1 µg/L
2,4-di-tert-butylphenol	14.5%	12.4%	1 µg/L

Table 4: Performance obtained with tandem mass spectrometry.

COMPENDIUM OF INTERNATIONAL ANALYSIS OF METHODS - OIV
Determination of alkylphenols in wines by gas chromatography-mass spectrometry
(GC-MS or GC-MS/MS)

11. Annex 2: Example chromatograms and calibration curves

11.1 2-tert-butylphenol

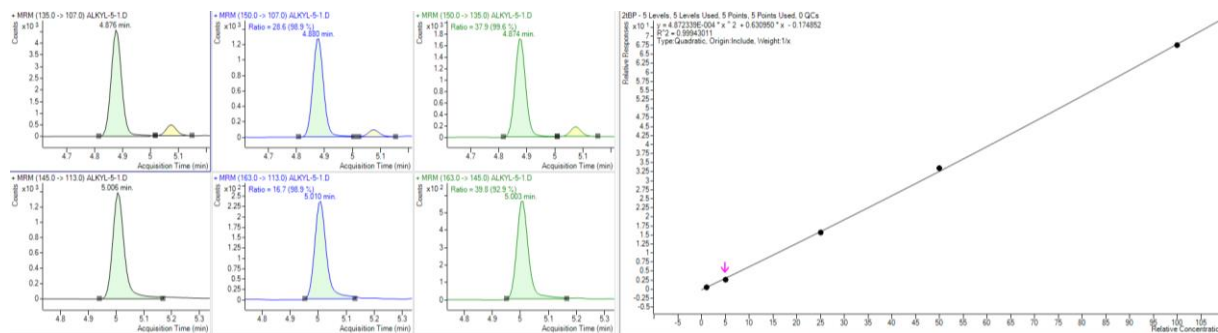

11.2 4-tert-butylphenol

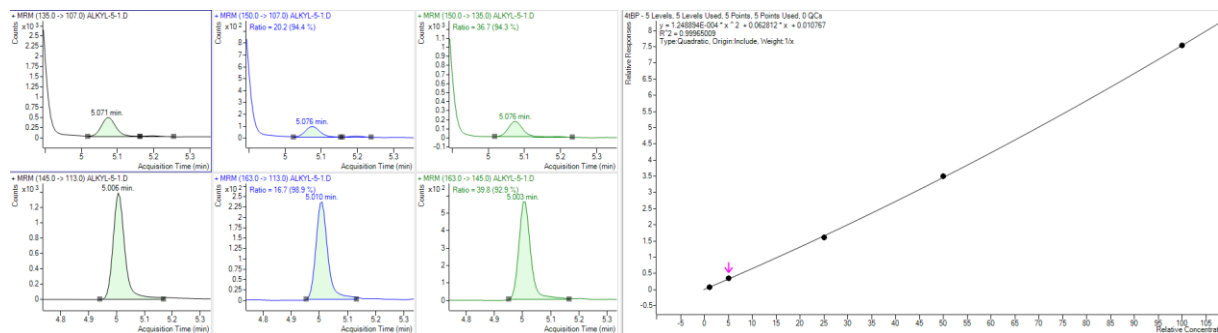

COMPENDIUM OF INTERNATIONAL ANALYSIS OF METHODS - OIV
Determination of alkylphenols in wines by gas chromatography-mass spectrometry
(GC-MS or GC-MS/MS)

11.3 6-methyl-2-tert-butylphenol

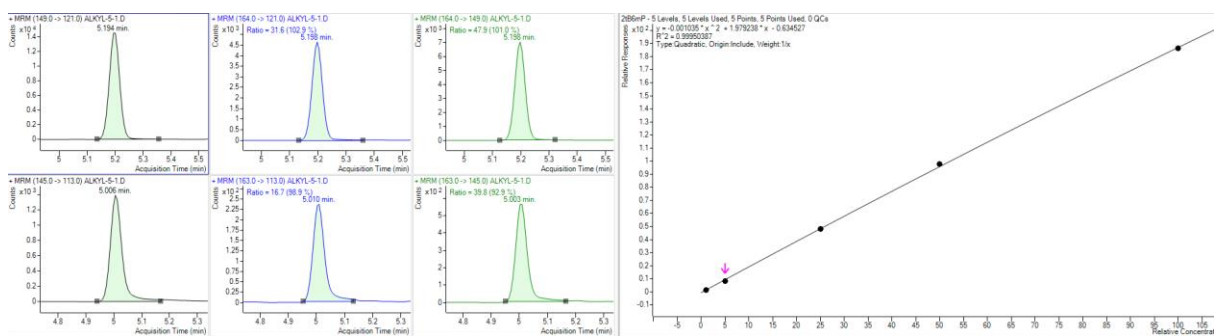

11.4 4-methyl-2-tert-butylphenol

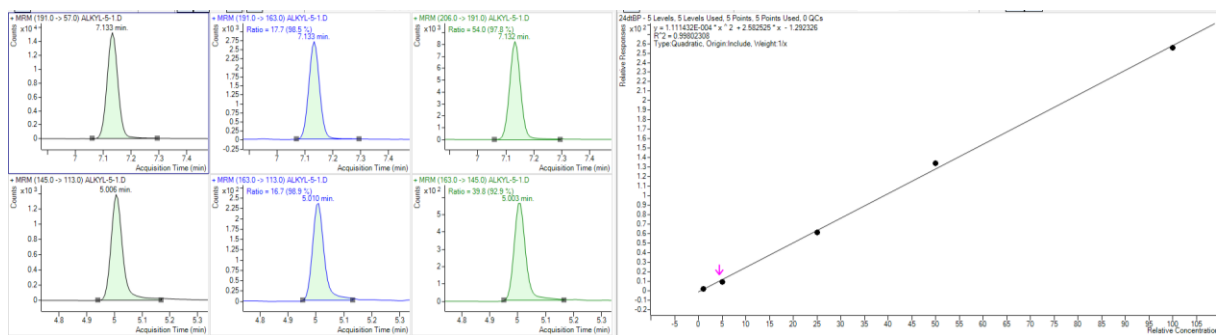

COMPENDIUM OF INTERNATIONAL ANALYSIS OF METHODS - OIV
Determination of alkylphenols in wines by gas chromatography-mass spectrometry
(GC-MS or GC-MS/MS)

11.5 5-methyl-2-tert-butylphenol

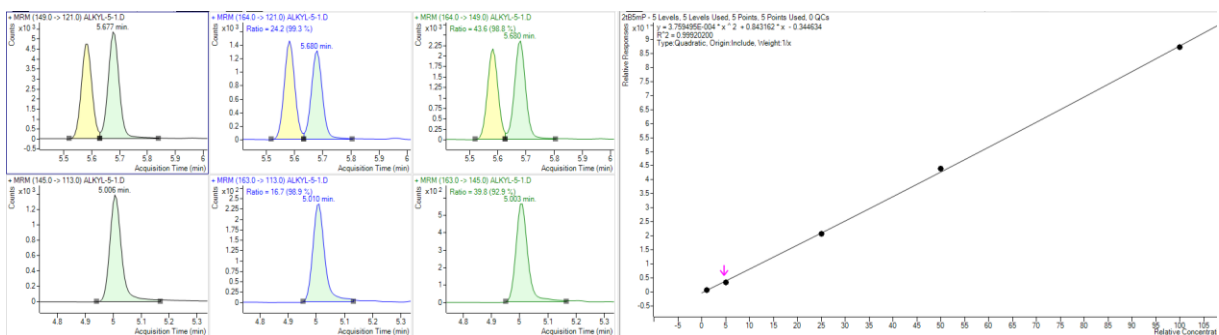

11.6 4,6-dimethyl-2-tert-butylphenol

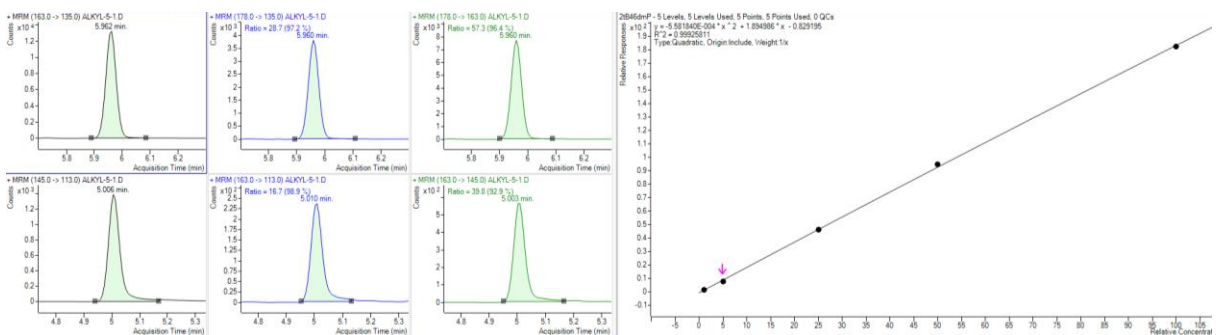

COMPENDIUM OF INTERNATIONAL ANALYSIS OF METHODS - OIV
Determination of alkylphenols in wines by gas chromatography-mass spectrometry
(GC-MS or GC-MS/MS)

11.7 2,6-di-tert-butylphenol

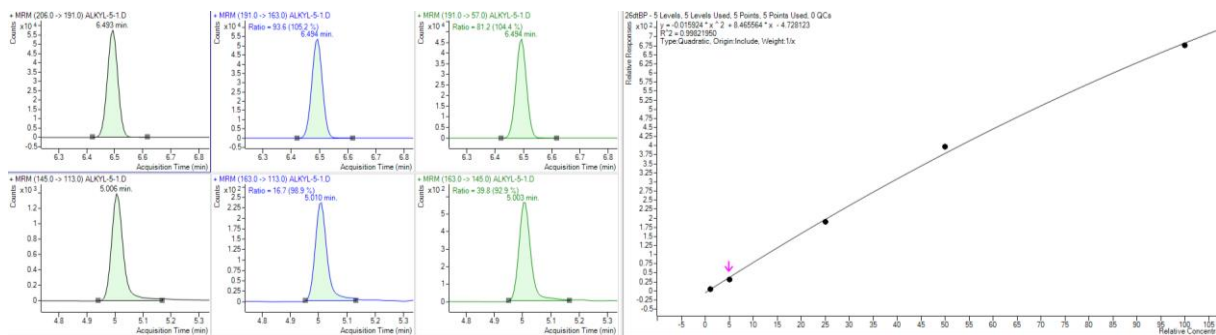

11.8 2,4-di-tert-butylphenol

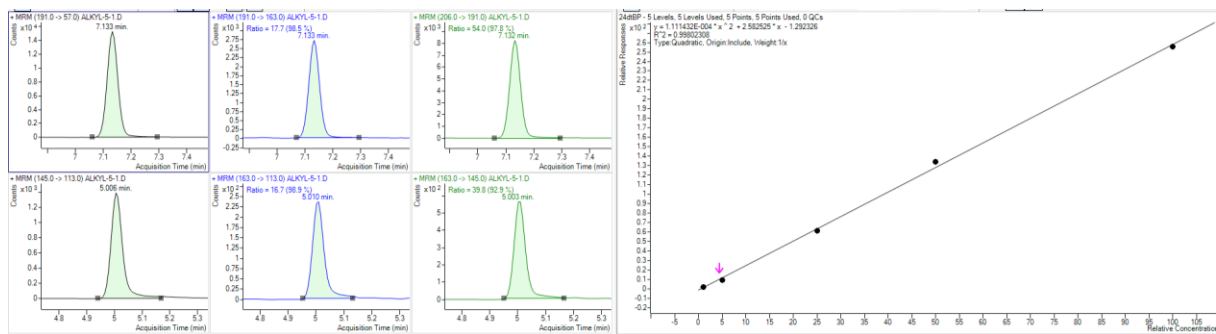

COMPENDIUM OF INTERNATIONAL METHODS OF ANALYSIS – OIV
Qualitative determination of sweeteners in wine by liquid
chromatography coupled with mass spectrometry (LC-MS)

Method OIV-MA-AS315-31

Type IV Method

Qualitative determination of sweeteners in wine by liquid
chromatography coupled with mass spectrometry (LC-MS)

(Resolution OIV-OENO 636-2021)

1. Scope

This method is suitable for the determination of presence of five artificial sweeteners (aspartame, potassium acesulfame, sodium cyclamate, saccharin and sucralose) as well as the natural sweetener stevioside in white, rosé and red wine.

2. Definitions

ESI – Electrospray Ionisation

LC – Liquid chromatography

LC-MS – Liquid chromatography coupled with mass spectrometry

m/z – Mass to charge ratio

MS – Mass spectrometry

MS/MS – Mass spectrometry acquisition mode measuring product ions

QTOF – Quadrupole time-of-flight mass spectrometry

RP – Reverse phase

RT – Retention time

UHPLC – Ultra-high-performance liquid chromatography

COMPENDIUM OF INTERNATIONAL METHODS OF ANALYSIS – OIV
Qualitative determination of sweeteners in wine by liquid
chromatography coupled with mass spectrometry (LC-MS)

3. Principle

Wine is analysed directly using a liquid chromatography coupled with mass spectrometry system (LC-MS). In liquid chromatography (LC), separation is performed using a reverse phase (RP) column and detection is accomplished by mass spectrometry (MS) according to the compounds' mass to charge ratio (m/z). The MS data combined with the retention time (RT) are used for the identification and quantitation of sweeteners.

4. Reagents and materials

4.1. Reagents:

- 4.1.1. Acetonitrile, purity ≥ 99.95 % (CAS Number 75-05-8)
- 4.1.2. Purified water: 18 M Ω .cm, TOC ≤ 5 μ g/L
- 4.1.3. Formic Acid, purity ≥ 98 % (CAS Number 64-18-6)
- 4.1.4. Aspartame, purity ≥ 99.0 % (CAS Number 22839-47-0)
- 4.1.5. Acesulfame K, purity ≥ 99.9 % (CAS Number 55589-62-3)
- 4.1.6. Cyclamate, Sodium, purity ≥ 99.8 % (CAS Number 139-05-9)
- 4.1.7. Saccharin, purity ≥ 99 % (CAS Number 81-07-2)
- 4.1.8. Sucralose, purity ≥ 98.0 % (CAS Number 56038-13-2)
- 4.1.9. Stevioside, purity ≥ 95.0 % (CAS Number 57817-89-7)
- 4.1.10. Wines representative of the working matrices and previously verified to be absent of any sweeteners in order to be used for the preparation of calibration solutions and standards.

4.2. Solution preparation (as an example)

Standards and calibration solutions are kept in the fridge at approximately 6 °C. Aspartame solutions are unstable in acid media. Therefore, they must be prepared fresh each time the standard is analysed.

4.2.1. Standard solutions

Individual standard solutions at 1 g/L are prepared, e.g., by dissolving 10.0 mg of each sweetener in 10 mL volumetric flasks and filling up to the mark with water (4.1.2) or with ethanol solution at 12% V/V.

4.2.2. Calibration standards

OIV-MA-AS315-31: R2021

COMPENDIUM OF INTERNATIONAL METHODS OF ANALYSIS – OIV
Qualitative determination of sweeteners in wine by liquid
chromatography coupled with mass spectrometry (LC-MS)

Calibration standards are prepared and analysed by LC-MS as any other sample (see 6).

The calibration standards are prepared in wine (4.1.10) by diluting the appropriate amount of standard solution (4.2.1) to obtain the concentrations 50 µg/L, 100 µg/L, 500 µg/L and 1000 µg/L of each sweetener. If better method performance is needed it is recommended to perform calibration with the same matrix being evaluated.

5. Apparatus

- 5.1. Syringe filters: 0.2 µm polypropylene membrane, 25 mm diameter.
- 5.2. Laboratory glassware, namely class A volumetric flasks.
- 5.3. Analytical balance with a resolution of ±0.0001 g.
- 5.4. Micropipettes for volumes from 5 µL to 1000 µL.
- 5.5. High Performance Liquid Chromatography instrument coupled with mass spectrometer.
 - 5.5.1. Standard HPLC and UPLC systems are possible given that the chromatographic separation is adjusted accordingly.
 - 5.5.2. Several MS system configurations are possible such as quadrupole, ion trap, time-of-flight and also hybrid systems.

6. Sampling

Each wine sample is prepared by filtration with a syringe filter (5.1) prior to injection.

If necessary, samples are degassed beforehand using, for example, an ultrasound bath or nitrogen bubbling. If concentrations fall outside the calibration range, samples should be diluted.

Better performance may also be achieved with additional sample preparation steps such as dilution (relying on the instrument sensitivity), sample cleanup and extraction.

7. Procedure

COMPENDIUM OF INTERNATIONAL METHODS OF ANALYSIS – OIV
Qualitative determination of sweeteners in wine by liquid chromatography coupled with mass spectrometry (LC-MS)

The following description, given as an example, refers to a UHPLC-QTOF instrument equipped with an ESI source. Modifications may occur according to the type of equipment or manufacturer's instructions.

7.1. LC analysis:

- Mobile phase A: purified water (4.1.2) with 0.1 % formic acid (4.1.3)
- Mobile phase B: acetonitrile (4.1.1) with 0.1 % formic acid (4.1.3)
- Injection volume: 2 μ L
- Sampler temperature: 10 °C
- Column: RP C8 2.1 mm x 100 mm, 1.9 μ m
- Column Oven: 30 °C

- Gradient:

Time Min	Flow mL/min	% A	% B
0	0.4	90	10
3	0.4	60	40
3	0.4	1	99
4	0.4	1	99
4	0.8	1	99
5.5	0.8	1	99
5.5	0.5	90	10
9.5	0.5	90	10
9.5	0.4	90	10
10	0.4	90	10

7.2. Mass Spectrometer parameters:

- ESI: negative ionisation
- Source Temp: 200 °C
- Capillary Voltage: 3000 V
- Acquisition Mode: broadband collision-induced dissociation (bbCID)
 - Consists of alternating acquisition of spectra of Full Scan and MS/MS modes (acquisition of precursor and product ions respectively)
- Collision Energy: 30 eV
- Acquisition spectra rate: 2.0 Hz
- Dry Gas Flow: 8 L/min;

OIV-MA-AS315-31: R2021

COMPENDIUM OF INTERNATIONAL METHODS OF ANALYSIS – OIV
Qualitative determination of sweeteners in wine by liquid chromatography coupled with mass spectrometry (LC-MS)

- Nebuliser pressure: 2.0×10^5 Pa (2.0 bar)

8. Identification

Sweetener identification is confirmed using a standard for each compound (4.1.4, 4.1.5, 4.1.6, 4.1.7, 4.1.8 and 4.1.9). The data gathered for peak confirmation is the RT for guidance (these may vary depending on the chromatographic parameters) and m/z of the precursor and product ions (Table 1).

Table 1 – Sweeteners identification data: RT, precursor m/z and product m/z

Sweetener	RT min	Ion	Precursor m/z	Product m/z
Acesulfame K	1.24	[M] ⁻	<u>161.9867</u>	77.9655
Aspartame	2.30	[M-H] ⁻	<u>293.1143</u>	261.0881
Cyclamate Na	1.66	[M] ⁻	<u>178.0543</u>	79.9574
Saccharin	1.55	[M-H] ⁻	<u>181.9917</u>	41.9985
Sucralose	2.14	[M-H] ⁻	<u>395.0073</u>	359.0306
Stevioside	3.63	[M-H] ⁻	803.3707	<u>641.3026</u>

Note: The ions used for quantitation are underlined in Table 1.

Ion signals are monitored with extracted ion chromatograms with ± 3 mDa tolerance (Figure 1).

COMPENDIUM OF INTERNATIONAL METHODS OF ANALYSIS – OIV
Qualitative determination of sweeteners in wine by liquid
chromatography coupled with mass spectrometry (LC-MS)

Figure 1 – Precursor and product peak confirmation for 250 µg/L standard

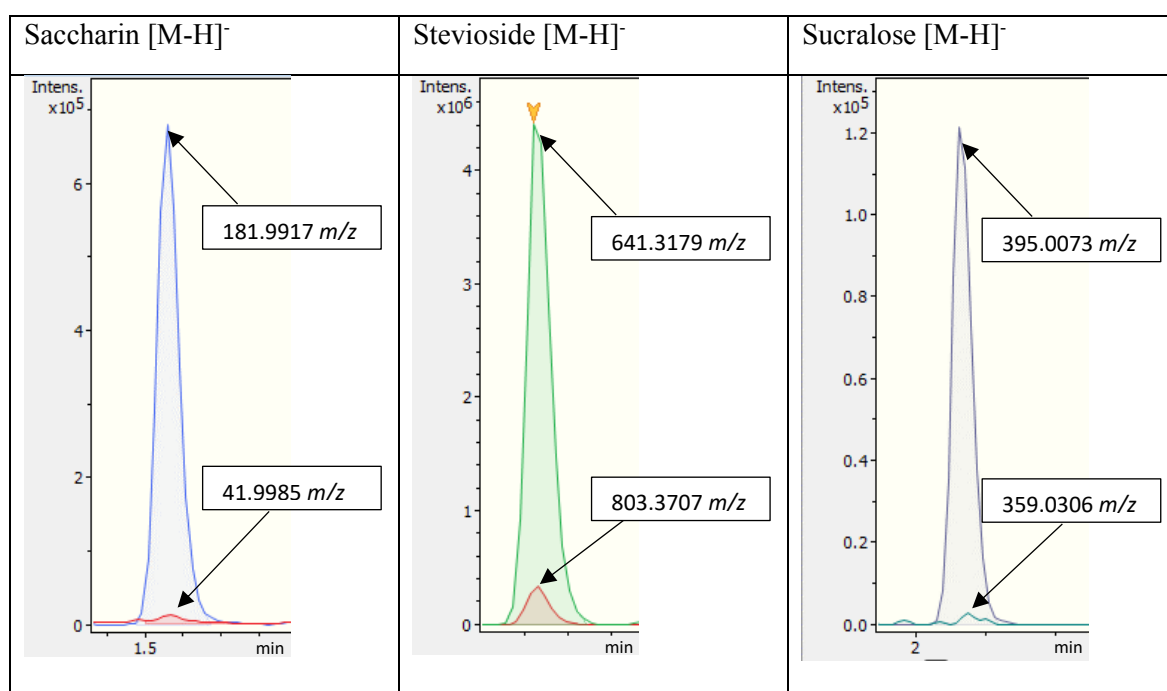
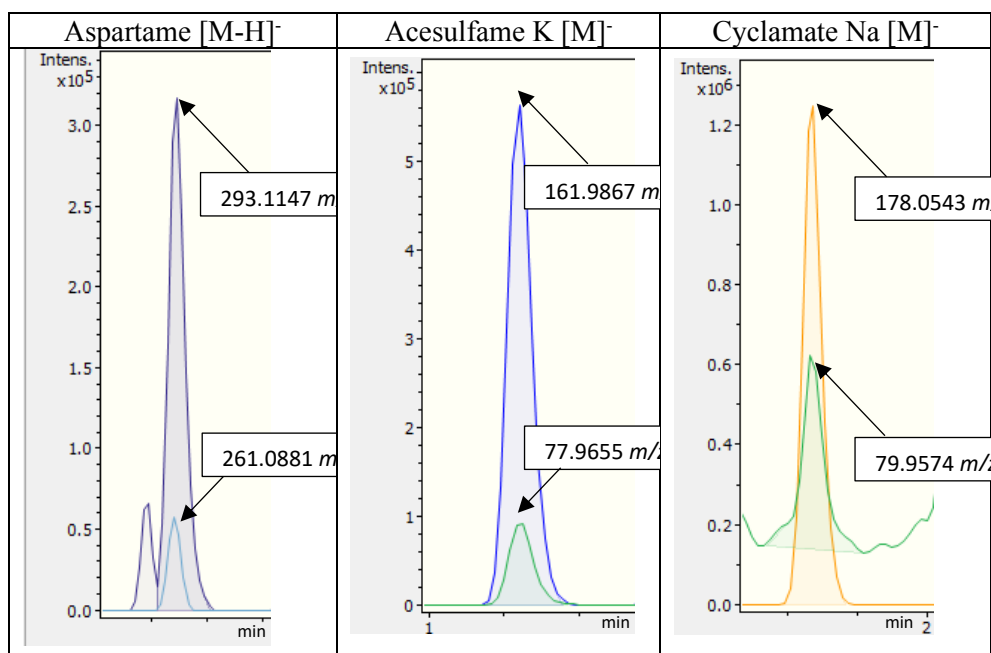

Note: An example of low standard sensitivity and additional transitions are given in appendix

COMPENDIUM OF INTERNATIONAL METHODS OF ANALYSIS – OIV
Qualitative determination of sweeteners in wine by liquid
chromatography coupled with mass spectrometry (LC-MS)

9. Calculus

Results are calculated from the calibration curve which is obtained with the amount (µg/L) vs the peak area of each sweetener:

$$C = \frac{A_S - Int}{S}$$

Where *C* is the sweetener concentration (µg/L), *A_S* is the sample peak area, *Int* is the calibration curve Y-axis interception point and *S* is the calibration curve slope.

10. Results

Concentrations are expressed in µg/L without decimals.

11. Internal validation

11.1. Matrices

Validation was performed using a total of 43 different wines: 20 red wines, 10 rosé wines and 13 white wines. These wines were selected from several regions with the aim of obtaining great variability of characteristics in order to make a comprehensive approach. Bellow there is a table summarizing the major characteristics of the wines.

Table 2 – Matrices main characteristics

	Red wine (R)		Rosé wine (Ro)		White wine (W)	
Regions	Alentejo	4	Douro	3	Açores	1
	Bairrada	1	Vinho Verde	1	Alentejo	2
	Dão	3	Other ⁽¹⁾	6	Dão	1
	Douro	4			Douro	1
	Lisboa	1			Lisboa	1
	Valladolid	1			Vinho Verde	4
	Other ⁽¹⁾	6			Other ⁽¹⁾	3

COMPENDIUM OF INTERNATIONAL METHODS OF ANALYSIS – OIV
Qualitative determination of sweeteners in wine by liquid
chromatography coupled with mass spectrometry (LC-MS)

Alcoholic Strength by Volume % v/v	12.1 – 17.2	9.8 – 12.6	8.7 – 13.6
Sugar content g/L (glucose + fructose)	0.5 – 108.0	0.7 – 28.8	0.2 – 17.1
Total Acidity g/L (tartaric acid)	4.6 – 6.4	4.7 – 6.0	5.2 – 7.1
pH	3.5 – 3.8	3.2 – 3.5	3.2 – 3.4
Intensity	2.4 – 16.2	0.1 – 0.5	0.03 – 0.29 ⁽²⁾

⁽¹⁾ Without geographical indication

⁽²⁾ Absorbance at 420 nm instead of intensity

11.2. Linearity

The method proved to be linear within a range of concentrations between 50 µg/L and 1000 µg/L

11.3. Calibration

A total of 14 independent calibrations were made counting 6 red wines, 4 rosé wines and 4 white wines. Then, for each compound, calibrations were made considering 3 different approaches:

- One unified calibration for all the matrices
- 2 groups of matrices consisting in one group for white wines and another group with the remaining wines (red wines and rosé wines)
- 3 groups of matrices consisting of white wines, rosé wines and red wines

Herein presented are the optimized results of the validation study. According to the selected calibration conditions, for acesulfame, saccharin and sucralose calibration functions and subsequent calculations were performed considering one group for white wines and a second group with the remaining matrices, red wines

COMPENDIUM OF INTERNATIONAL METHODS OF ANALYSIS – OIV
Qualitative determination of sweeteners in wine by liquid
chromatography coupled with mass spectrometry (LC-MS)

and rosé wines. For aspartame, cyclamate and stevioside three groups of matrices were considered: red wines, rosé wines and white wines.

Table 3 – Calibration scheme for each compound

Calibrations	Individual			Combined
	White wine	Rosé wine	Red wine	Red wines + Rosé wines
Acesulfame	X			X
Aspartame	X	X	X	
Cyclamate	X	X	X	
Saccharin	X			X
Stevioside	X	X	X	
Sucralose	X			X

Given the heteroskedasticity and normal distribution of the residuals, the regression model employed was the weighted least square regression.

As an example, sucralose for the group of red and rosé wines at a concentration range 50 µg/L to 1000 µg/L is presented below.

Figure 2 – Calibration curve, standardized residuals and Q-Q plot for the combined red and rosé wines calibration for sucralose

COMPENDIUM OF INTERNATIONAL METHODS OF ANALYSIS – OIV
Qualitative determination of sweeteners in wine by liquid chromatography coupled with mass spectrometry (LC-MS)

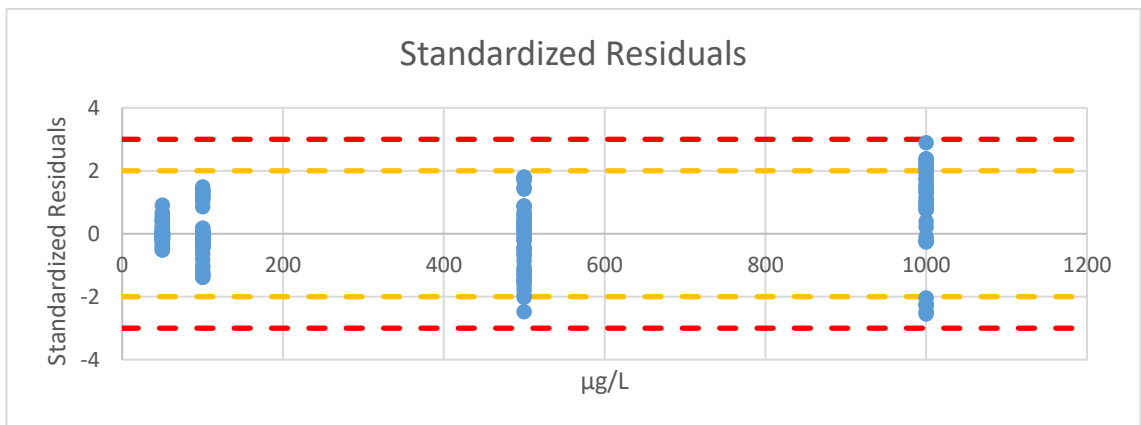
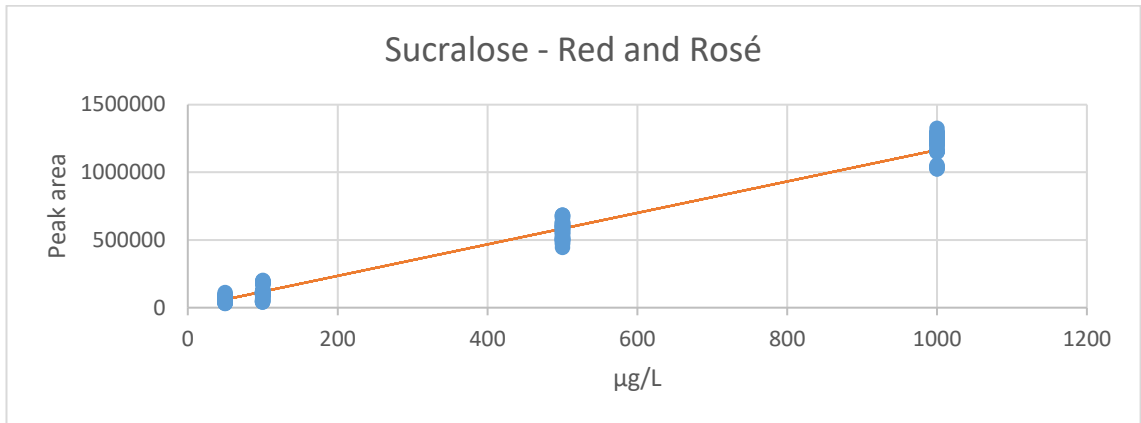

yellow	2x standard deviation
red	3x standard deviation

COMPENDIUM OF INTERNATIONAL METHODS OF ANALYSIS – OIV
Qualitative determination of sweeteners in wine by liquid chromatography coupled with mass spectrometry (LC-MS)

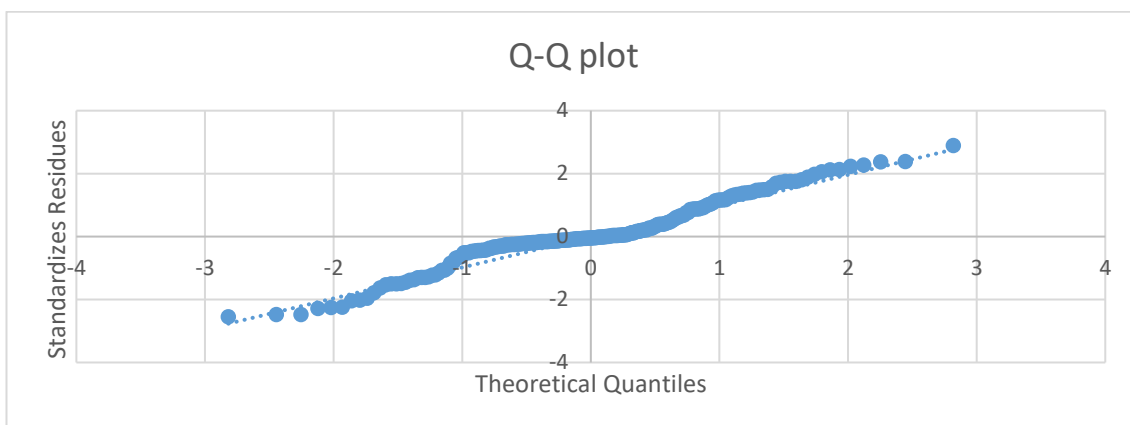

11.4. Limits of detection and limits of quantitation

The limits of quantitation were obtained through calculation from the calibration curves

Table 4 – LOD and LOQ values obtained for each compound

	LOD (mg/L)			LOQ (mg/L)		
	White wine	Rosé wine	Red wine	White wine	Rosé wine	Red wine
Acesulfame K	0.003	0.003		0.011	0.011	
Aspartame	0.004	0.006	0.004	0.014	0.019	0.014
Cyclamate Na	0.002	0.005	0.004	0.006	0.015	0.014
Saccharin	0.002	0.005		0.006	0.016	
Stevioside	0.002	0.002	0.005	0.005	0.005	0.016

OIV-MA-AS315-31: R2021

COMPENDIUM OF INTERNATIONAL METHODS OF ANALYSIS – OIV
Qualitative determination of sweeteners in wine by liquid
chromatography coupled with mass spectrometry (LC-MS)

Sucralose	0.014	0.007	0.048	0.022
------------------	-------	-------	-------	-------

11.5. Repeatability

Repeatability was assessed at three spiking levels: 50 µg/L corresponding to the reporting limit, 250 µg/L and 1000 µg/L. This evaluation is based on 8 replicate injections at each spiking level and for each matrix.

In the following tables the repeatability values obtained for each sweetener are presented including the mean concentration measured in each sample, the standard deviation (Std. Dev.), the percentual relative standard deviation for repeatability (RSDr %) and the Horwitz Ratio for repeatability (HorRat (r)).

Table 5 – Repeatability values for potassium acesulfame at 3 spiking levels

Acesulfame	White wine (W)								
	Sample	W1	W2	W3	W4	W5	W6	W7	W8
Mean µg/L	45	42	49	233	207	240	1036	926	1060
Std. Dev.	1.4	2.1	0.8	3.3	5.2	2.6	13.2	13.7	15.8
Recovery %	89 %	84 %	98 %	93 %	83 %	96 %	104 %	93 %	106 %
RSDr %	3.2 %	5.0 %	1.6 %	1.4 %	2.5 %	1.1 %	1.3 %	1.5 %	1.5 %
HorRat (r)	0.13	0.20	0.06	0.07	0.13	0.05	0.08	0.09	0.09

COMPENDIUM OF INTERNATIONAL METHODS OF ANALYSIS – OIV
Qualitative determination of sweeteners in wine by liquid
chromatography coupled with mass spectrometry (LC-MS)

Acesulfame	Rosé wine (Ro)								
Sample	Ro1	Ro2	Ro3	Ro4	Ro5	Ro6	Ro7	Ro8	Ro9
Mean µg/L	49	52	53	248	248	247	1063	1091	1097
Std. Dev.	2.0	1.2	1.4	2.9	3.5	3.9	14.1	13.2	15.5
Recovery %	98 %	104 %	107 %	99 %	99 %	99 %	106 %	109 %	110 %
RSDr %	4.1 %	2.3 %	2.6 %	1.2 %	1.4 %	1.6 %	1.3 %	1.2 %	1.4 %
HorRat (r)	0.17	0.09	0.10	0.06	0.07	0.08	0.08	0.08	0.09

Acesulfame	Red wine (R)								
Sample	R1	R2	R3	R4	R5	R6	R7	R8	R9
Mean µg/L	56	50	57	275	241	260	1195	1064	1160
Std. Dev.	1.2	2.0	1.4	3.2	5.1	4.3	13.8	14.5	10.0
Recovery %	112 %	101 %	115 %	110 %	96 %	104 %	120 %	106 %	116 %
RSDr %	2.1 %	3.9 %	2.4 %	1.2 %	2.1 %	1.6 %	1.2 %	1.4 %	0.9 %
HorRat (r)	0.08	0.16	0.10	0.06	0.11	0.08	0.07	0.09	0.05

Table 6 - Repeatability values for aspartame at 3 spiking levels

Aspartame	White wine (W)								
Sample	W1	W2	W3	W4	W5	W6	W7	W8	W9
Mean µg/L	34	51	45	237	231	235	981	973	982
Std. Dev.	7.3	4.2	6.7	27.5	7.6	10.9	29.0	18.0	23.2

OIV-MA-AS315-31: R2021

COMPENDIUM OF INTERNATIONAL METHODS OF ANALYSIS – OIV
Qualitative determination of sweeteners in wine by liquid chromatography coupled with mass spectrometry (LC-MS)

Recovery %	68 %	101 %	91 %	95 %	92 %	94 %	98 %	97 %	98 %
RSDr %	21.6 %	8.3 %	14.7 %	11.6 %	3.3 %	4.6 %	3.0 %	1.8 %	2.4 %
HorRat (r)	0.87	0.33	0.59	0.59	0.17	0.24	0.19	0.12	0.15

Aspartame	Rosé wine (Ro)								
Sample	Ro1	Ro2	Ro3	Ro4	Ro5	Ro6	Ro7	Ro8	Ro9
Mean µg/L	38	42	41	200	211	210	833	905	916
Std. Dev.	3.0	2.9	4.3	6.8	5.2	5.9	20.9	34.0	22.5
Recovery %	75 %	85 %	82 %	80 %	84 %	84 %	83 %	90 %	92 %
RSDr %	8.0 %	6.9 %	10.6 %	3.4 %	2.5 %	2.8 %	2.5 %	3.8 %	2.5 %
HorRat (r)	0.32	0.28	0.43	0.17	0.13	0.14	0.16	0.24	0.15
Aspartame	Red wine (R)								
Sample	R1	R2	R3	R4	R5	R6	R7	R8	R9
Mean µg/L	46	51	50	227	254	230	956	1099	1013
Std. Dev.	8.6	3.2	8.1	16.9	10.4	7.3	21.8	39.0	20.2
Recovery %	92 %	103 %	100 %	91 %	102 %	92 %	96 %	110 %	101 %
RSDr %	18.5 %	6.3 %	16.2 %	7.4 %	4.1 %	3.2 %	2.3 %	3.5 %	2.0 %
HorRat (r)	0.74	0.25	0.65	0.38	0.21	0.16	0.14	0.22	0.13

Table 7 - Repeatability values for sodium cyclamate at 3 spiking levels

Cyclamate	White wine (W)								
------------------	----------------	--	--	--	--	--	--	--	--

OIV-MA-AS315-31: R2021

COMPENDIUM OF INTERNATIONAL METHODS OF ANALYSIS – OIV
Qualitative determination of sweeteners in wine by liquid
chromatography coupled with mass spectrometry (LC-MS)

Sample	W1	W2	W3	W4	W5	W6	W7	W8	W9
Mean µg/L	51	50	50	261	247	246	1092	1040	1045
Std. Dev.	1.0	1.4	1.4	2.8	4.2	3.5	12.2	17.7	14.4
Recovery %	103 %	100 %	101 %	104 %	99 %	99 %	109 %	104 %	105 %
RSDr %	1.9 %	2.9 %	2.9 %	1.1 %	1.7 %	1.4 %	1.1 %	1.7 %	1.4 %
HorRat (r)	0.08	0.12	0.11	0.05	0.09	0.07	0.07	0.11	0.09

Cyclamate	Rosé wine (Ro)								
Sample	Ro1	Ro2	Ro3	Ro4	Ro5	Ro6	Ro7	Ro8	Ro9
Mean µg/L	42	42	44	232	228	233	982	992	1002
Std. Dev.	1.6	1.3	0.8	2.8	4.4	4.5	14.9	6.0	12.9
Recovery %	84 %	85 %	88 %	93 %	91 %	93 %	98 %	99 %	100 %
RSDr %	3.9 %	3.0 %	1.7 %	1.2 %	2.0 %	1.9 %	1.5 %	0.6 %	1.3 %
HorRat (r)	0.16	0.12	0.07	0.06	0.10	0.10	0.10	0.04	0.08

Cyclamate	Red wine (R)								
Sample	R1	R2	R3	R4	R5	R6	R7	R8	R9
Mean µg/L	51	55	54	250	265	243	1069	1160	1086
Std. Dev.	1.2	1.3	1.4	5.5	5.2	4.2	27.4	13.9	18.4
Recovery %	103 %	110 %	108 %	100 %	106 %	97 %	107 %	116 %	109 %
RSDr %	2.4 %	2.4 %	2.6 %	2.2 %	2.0 %	1.7 %	2.6 %	1.2 %	1.7 %

OIV-MA-AS315-31: R2021

COMPENDIUM OF INTERNATIONAL METHODS OF ANALYSIS – OIV
Qualitative determination of sweeteners in wine by liquid chromatography coupled with mass spectrometry (LC-MS)

HorRat (r)	0.10	0.10	0.10	0.11	0.10	0.09	0.16	0.08	0.11
-------------------	------	------	------	------	------	------	------	------	------

Table 8 - Repeatability values for saccharin at 3 spiking levels

Saccharin	White wine (W)								
Sample	W1	W2	W3	W4	W5	W6	W7	W8	W9
Mean µg/L	45	45	59	216	214	252	920	909	1055
Std. Dev.	1.5	1.4	1.4	5.1	5.1	3.7	21.3	23.7	21.5
Recovery %	89 %	91 %	119 %	86 %	86 %	101 %	92 %	91 %	105 %
RSDr %	3.3 %	3.0 %	2.4 %	2.4 %	2.4 %	1.5 %	2.3 %	2.6 %	2.0 %
HorRat (r)	0.13	0.12	0.10	0.12	0.12	0.08	0.15	0.16	0.13

Saccharin	Rosé wine (Ro)								
Sample	Ro1	Ro2	Ro3	Ro4	Ro5	Ro6	Ro7	Ro8	Ro9
Mean µg/L	58	56	56	303	276	278	1263	1190	1204
Std. Dev.	1.4	2.0	0.6	5.5	3.5	4.8	28.8	24.8	25.2
Recovery %	116 %	112 %	112 %	121 %	110 %	111 %	126 %	119 %	120 %
RSDr %	2.4 %	3.5 %	1.1 %	1.8 %	1.3 %	1.7 %	2.3 %	2.1 %	2.1 %
HorRat (r)	0.10	0.14	0.04	0.09	0.07	0.09	0.14	0.13	0.13
Saccharin	Red wine (R)								

OIV-MA-AS315-31: R2021

COMPENDIUM OF INTERNATIONAL METHODS OF ANALYSIS – OIV
Qualitative determination of sweeteners in wine by liquid
chromatography coupled with mass spectrometry (LC-MS)

Sample	R1	R2	R3	R4	R5	R6	R7	R8	R9
Mean µg/L	47	44	46	224	203	199	955	906	885
Std. Dev.	1.4	0.5	1.5	4.4	2.2	2.9	20.6	20.1	25.8
Recovery %	94 %	88 %	92 %	89 %	81 %	80 %	95 %	91 %	88 %
RSDr %	3.0 %	1.1 %	3.2 %	2.0 %	1.1 %	1.5 %	2.2 %	2.2 %	2.9 %
HorRat (r)	0.12	0.04	0.13	0.10	0.06	0.07	0.14	0.14	0.18

Table 9 - Repeatability values for stevioside at 3 spiking levels

Stevioside	White wine (W)								
Sample	W1	W2	W3	W4	W5	W6	W7	W8	W9
Mean µg/L	41	43	30	262	265	204	1094	1116	860
Std. Dev.	0.4	0.4	0.7	2.0	31.2	1.9	13.6	12.9	6.6
Recovery %	83 %	86 %	60 %	105 %	106 %	81 %	109 %	112 %	86 %
RSDr %	1.0 %	1.0 %	2.2 %	0.8 %	11.8 %	0.9 %	1.2 %	1.2 %	0.8 %
HorRat (r)	0.04	0.04	0.09	0.04	0.60	0.05	0.08	0.07	0.05

Stevioside	Rosé wine (Ro)								
Sample	Ro1	Ro2	Ro3	Ro4	Ro5	Ro6	Ro7	Ro8	Ro9
Mean µg/L	50	39	41	237	254	286	935	1104	1109
Std. Dev.	0.8	1.3	0.9	2.6	5.3	7.1	10.5	10.2	18.3
Recovery %	99 %	77 %	81 %	95 %	102 %	114 %	93 %	110 %	111 %

OIV-MA-AS315-31: R2021

COMPENDIUM OF INTERNATIONAL METHODS OF ANALYSIS – OIV
Qualitative determination of sweeteners in wine by liquid
chromatography coupled with mass spectrometry (LC-MS)

RSDr %	1.7 %	3.4 %	2.2 %	1.1 %	2.1 %	2.5 %	1.1 %	0.9 %	1.6 %
HorRat (r)	0.07	0.14	0.09	0.06	0.11	0.13	0.07	0.06	0.10

Stevioside	Red wine (R)								
Sample	R1	R2	R3	R4	R5	R6	R7	R8	R9
Mean µg/L	60	40	43	262	211	210	1048	904	921
Std. Dev.	0.9	0.7	0.4	4.0	4.0	2.6	18.0	18.4	11.9
Recovery %	120 %	80 %	86 %	105 %	85 %	84 %	105 %	90 %	92 %
RSDr %	1.5 %	1.8 %	1.0 %	1.5 %	1.9 %	1.3 %	1.7 %	2.0 %	1.3 %
HorRat (r)	0.06	0.07	0.04	0.08	0.10	0.06	0.11	0.13	0.08

Table 10 - Repeatability values for sucralose at 3 spiking levels

Sucralose	White wine (W)								
Sample	W1	W2	W3	W4	W5	W6	W7	W8	W9
Mean µg/L	53	52	53	221	225	223	986	973	1021
Std. Dev.	5.3	7.8	8.1	10.8	27.5	6.5	29.8	43.9	31.5
Recovery %	106 %	103 %	105 %	88 %	90 %	89 %	99 %	97 %	102 %

OIV-MA-AS315-31: R2021

COMPENDIUM OF INTERNATIONAL METHODS OF ANALYSIS – OIV
Qualitative determination of sweeteners in wine by liquid
chromatography coupled with mass spectrometry (LC-MS)

RSDr %	10.0 %	15.1 %	15.4 %	4.9 %	12.2 %	2.9 %	3.0 %	4.5 %	3.1 %
HorRat (r)	0.40	0.61	0.62	0.25	0.63	0.15	0.19	0.28	0.19
Sucralose	Rosé wine (Ro)								
Sample	Ro1	Ro2	Ro3	Ro4	Ro5	Ro6	Ro7	Ro8	Ro9
Mean µg/L	35	43	36	215	236	194	944	1075	905
Std. Dev.	4.1	2.1	2.2	7.2	7.4	7.7	21.3	27.5	19.3
Recovery %	70 %	86 %	71 %	86 %	94 %	78 %	94 %	108 %	91 %
RSDr %	11.7 %	5.0 %	6.2 %	3.3 %	3.1 %	4.0 %	2.3 %	2.6 %	2.1 %
HorRat (r)	0.47	0.20	0.25	0.17	0.16	0.20	0.14	0.16	0.13

Sucralose	Red wine (R)								
Sample	R1	R2	R3	R4	R5	R6	R7	R8	R9
Mean µg/L	50	46	48	236	255	228	1017	1194	1041
Std. Dev.	7.7	3.1	6.8	11.5	9.2	8.4	16.9	27.5	23.0
Recovery %	100 %	92 %	96 %	94 %	102 %	91 %	102 %	119 %	104 %
RSDr %	15.3 %	6.9 %	14.1 %	4.9 %	3.6 %	3.7 %	1.7 %	2.3 %	2.2 %
HorRat (r)	0.61	0.28	0.57	0.25	0.18	0.19	0.10	0.15	0.14

COMPENDIUM OF INTERNATIONAL METHODS OF ANALYSIS – OIV
Qualitative determination of sweeteners in wine by liquid
chromatography coupled with mass spectrometry (LC-MS)

Table 11 – Repeatability summary table

Compound	Recovery	RSDr %	HorRat (r)
Acesulfame	83 % – 120 %	0.9 % – 5.0 %	0.05 – 0.20
Aspartame	68 % – 110 %	1.8 % – 21.6 %	0.12 – 0.87
Cyclamate	84 % – 116 %	0.6 % – 3.9 %	0.04 – 0.16
Saccharin	80 % – 126 %	1.1 % – 3.5 %	0.04 – 0.18
Stevioside	60 % – 112 %	0.8 % – 11.8 %	0.04 – 0.60
Sucralose	70 % – 119 %	1.7 % – 15.4 %	0.10 – 0.63

11.6. Intermediate Precision

Intermediate precision was evaluated by analyzing samples spiked with 50 µg/L, 250 µg/L and 1000 µg/L in different moments spanning throughout several days. The results are presented in the following tables. Count represents the number of points considered for the determination of the mean values and respective standard deviation (Std. Dev.). The recovery percentage, the relative standard deviation (RSD%) and the Horwitz ratio (HorRat) are also displayed for each case.

Table 12 – Intermediate precision values for potassium acesulfame at 3 spiking levels

Acesulfame	White wine (W)			Red (R) and Rosé wines (Ro)					
Sample	W1	W2	W3	Ro1	Ro2	Ro3	R1	R2	R3
Count	12	12	11	12	12	12	12	12	12
Mean µg/L	46	223	928	54	252	1089	53	252	1113
Std. Dev.	6.1	31.4	76.6	6.1	23.6	66.3	2.4	9.1	41.3
Recovery %	91 %	89 %	93 %	108 %	101 %	109 %	106 %	101 %	111 %

OIV-MA-AS315-31: R2021

COMPENDIUM OF INTERNATIONAL METHODS OF ANALYSIS – OIV
Qualitative determination of sweeteners in wine by liquid chromatography coupled with mass spectrometry (LC-MS)

RSD% IP	13.2 %	14.1 %	8.2 %	11.3 %	9.4 %	6.1 %	4.5 %	3.6 %	3.7 %
HorRat	0.53	0.72	0.52	0.46	0.48	0.38	0.18	0.18	0.23

Table 13 - Intermediate precision values for aspartame at 3 spiking levels

Aspartame	White wine (W)			Rosé wine (Ro)			Red (R)		
Sample	W1	W2	W3	Ro1	Ro2	Ro3	R1	R2	R3
Count	11	10	10	11	12	12	11	12	12
Mean µg/L	57	281	1190	41	202	841	41	222	998
Std. Dev.	5.5	21.8	91.9	4.1	12.9	73.9	7.5	15.4	43.5
Recovery %	114 %	113 %	119 %	82 %	81 %	84 %	83 %	89 %	100 %
RSD % IP	9.6 %	7.7 %	7.7 %	10.0 %	6.4 %	8.8 %	18.1 %	6.9 %	4.4 %
HorRat	0.38	0.40	0.49	0.40	0.32	0.55	0.73	0.36	0.27

Table 14 - Intermediate precision values for sodium cyclamate at 3 spiking levels

Cyclamate	White wine (W)			Rosé wine (Ro)			Red (R)		
Sample	W1	W2	W3	Ro1	Ro2	Ro3	R1	R2	R3
Count	10	10	10	11	12	12	12	12	12
Mean µg/L	48	237	1011	40	210	918	49	226	999
Std. Dev.	5.5	27.3	134.3	2.5	20.1	70.7	1.3	7.4	26.6
Recovery %	97%	95%	101%	80%	84%	92%	98%	91%	100 %
RSD% IP	11.3 %	11.5 %	13.3 %	6.3 %	9.6 %	7.7 %	2.7 %	3.3 %	2.7%
HorRat	0.45	0.59	0.84	0.25	0.49	0.48	0.11	0.17	0.17

OIV-MA-AS315-31: R2021

COMPENDIUM OF INTERNATIONAL METHODS OF ANALYSIS – OIV
Qualitative determination of sweeteners in wine by liquid
chromatography coupled with mass spectrometry (LC-MS)

Table 15 - Intermediate precision values for saccharin at 3 spiking levels

Saccharin	White wine (W)			Red (R) and Rosé wine (Ro)					
Sample	W1	W2	W3	Ro1	Ro2	Ro3	R1	R2	R3
Count	11	10	10	12	12	12	12	12	12
Mean µg/L	51	241	1010	56	270	1166	44	195	857
Std. Dev.	2.6	8.4	36.8	2.8	10.7	47.6	3.0	8.3	31.7
Recovery %	103 %	96%	101 %	112 %	108 %	117 %	88%	78%	86%
RSD % IP	5.0%	3.5 %	3.6%	5.1%	4.0%	4.1%	6.9 %	4.3 %	3.7 %
HorRat	0.20	0.18	0.23	0.20	0.20	0.26	0.28	0.22	0.23

Table 16 - Intermediate precision values for stevioside at 3 spiking levels

Stevioside	White wine (W)			Rosé wine (Ro)			Red (R)		
Sample	W1	W2	W3	Ro1	Ro2	Ro3	R1	R2	R3
Count	11	10	10	12	12	12	12	12	12
Mean µg/L	35	232	977	31	210	921	41	208	905
Std. Dev.	6.5	45.8	184.1	8.1	45.4	184.4	3.1	22.2	84.5
Recovery %	70%	93%	98%	61%	84%	92%	81 %	83%	91 %
RSD% IP	18.5 %	19.7 %	18.8 %	26.4 %	21.6 %	20.0 %	7.6 %	10.7 %	9.3 %
HorRat	0.74	1.01	1.19	1.06	1.10	1.26	0.31	0.55	0.59

COMPENDIUM OF INTERNATIONAL METHODS OF ANALYSIS – OIV
Qualitative determination of sweeteners in wine by liquid
chromatography coupled with mass spectrometry (LC-MS)

Table 17 - Intermediate precision values for sucralose at 3 spiking levels

Sucralose	White wine (W)			Red (R) and Rosé wine (Ro)					
	W1	W2	W3	Ro1	Ro2	Ro3	R1	R2	R3
Count	10	11	11	10	11	12	12	12	12
Mean µg/L	51	197	776	51	295	1196	42	228	106 9
Std. Dev.	10.4	41.6	137. 5	11.9	48.7	184. 5	5.3	18.0	51.3
Recovery %	101 %	79%	78%	101 %	118 %	120 %	85%	91 %	107 %
RSD % IP	20.5 %	21.1 %	17.7 %	23.5 %	16.5 %	15.4 %	12.5 %	7.9 %	4.8 %
HorRat	0.82	1.08	1.12	0.94	0.84	0.97	0.50	0.40	0.30

Table 18 - Intermediate precision summary table

Compound	Recovery	RSD%	HorRat
Acesulfame	89 % – 111 %	3.6 % – 14.1 %	0.18 – 0.72
Aspartame	81 % – 119 %	4.4 % – 18.1 %	0.27 – 0.73
Cyclamate	80 % – 101 %	2.7 % – 13.3 %	0.11 – 0.84
Saccharin	78 % – 117 %	3.5 % – 6.9 %	0.18 – 0.28
Stevioside	61 % – 98 %	7.6 % – 26.4 %	0.31 – 1.26
Sucralose	78 % – 120 %	4.8 % – 23.5 %	0.30 – 1.12

12. Bibliography

EUROPEAN COMMISSION DIRECTORATE GENERAL FOR HEALTH AND FOOD SAFETY, SANTE/11813/2017, “Analytical quality control and method validation procedures for pesticide residues and analysis in food and feed”. Implemented by 01/01/2018

OIV-MA-AS315-31: R2021

COMPENDIUM OF INTERNATIONAL METHODS OF ANALYSIS – OIV
Qualitative determination of sweeteners in wine by liquid
chromatography coupled with mass spectrometry (LC-MS)

Horwitz W., Albert R., 2006. The Horwitz Ratio (HorRat): A Useful Index of Method Performance with Respect to Precision. J AOAC Int, 89, 1095-1109.

OIV, 2021. International Code of Oenological Practices. Issue 2021, OIV, Paris.

Regulation (EC) No 1333/2008 of the European Parliament and of the Council of 16 December 2008 on food additives (Text with EEA relevance), 2008. OJ, L354, 16–33.

COMPENDIUM OF INTERNATIONAL METHODS OF ANALYSIS – OIV
Qualitative determination of sweeteners in wine by liquid
chromatography coupled with mass spectrometry (LC-MS)

Appendix

A1. Quantitation performance for a wine sample spiked with 50 µg/L of each sweetener

Sweetener	S/N
Acesulfame K	789.4
Aspartame	586.5
Cyclamate Na	282.5
Saccharin	24.3
Sucralose	80.5
Stevioside	224.1

A2 . Sweeteners identification data - additional transitions given as guidance

Sweetener	Additional transition in ESI negative
Acesulfame K	162 > 82
Aspartame	293 > 200
Cyclamate Na	178 > 96
Saccharin	182 > 106
Sucralose	397 > 361
Stevioside	641 > 479 641 > 317

**COMPENDIUM OF INTERNATIONAL ANALYSIS OF METHODS – OIV
Quantitation of glucose, malic acid, acetic acid, fumaric acid,
shikimic acid and sorbic acid in wine using quantitative nuclear
magnetic resonance spectrometry (1H NMR)**

Method OIV-MA-AS316-01

Type IV method

**Quantitation of glucose, malic acid, acetic acid, fumaric acid,
shikimic acid and sorbic acid in wine using quantitative nuclear
magnetic resonance spectrometry (¹H NMR)**
(Resolution Oeno 618/2020)

1. Introduction

NMR spectroscopy is a so called primary quantitative analytical technique with broad linear ranges (5-6 orders of magnitude). Multiple suppression of water and ethanol signals can significantly increase the sensitivity for matrices containing water and ethanol (such as wine) during automated measurements. Various compounds in wine can be identified and quantified by specific signals in only one analytical run.

2. Scope

The described method is suitable for the quantitative determination of glucose, malic acid, acetic acid, fumaric acid, shikimic acid at their natural concentrations in wine and in addition for the preserving agent sorbic acid.

Working range mg/L:

Glucose	600 – 50000
Malic acid	300 – 5000
Acetic acid	30 – 2000
Fumaric acid	20 – 300
Shikimic acid	20 – 500
Sorbic acid	20 – 800

3. Abbreviations

NMR Nuclear Magnetic Resonance

¹H NMR Proton Nuclear Magnetic Resonance

COMPENDIUM OF INTERNATIONAL ANALYSIS OF METHODS – OIV
Quantitation of glucose, malic acid, acetic acid, fumaric acid,
shikimic acid and sorbic acid in wine using quantitative nuclear
magnetic resonance spectrometry (1H NMR)

TSP 3 - (trimethylsilyl) propionic acid sodium salt

PULCON PULse length based CONcentration determination

4. Principle

The wine sample is diluted with 10% buffer in D₂O. TSP is used as an internal standard to adjust the chemical shift (□□ (0 ppm). After that the sample is measured by 1H NMR. At least single water suppression has to be applied. To increase sensitivity, also suppress the signal from the ethanol. The selected wine analytes are evaluated and quantified using appropriate signals (see 11.1 Annex Table 1).

5. Reagents and materials

The reagents used and the water (5.8) must be free from the analytes to be determined. Unless otherwise stated, solution means an aqueous solution.

5.1 D₂O (99.9 atom % D) CAS 7789-20-0

5.2. 3 - (trimethylsilyl) propionic acid 2,2,3,3-d₄ sodium salt (TSP) (98 atom % D)
CAS 24493-21-8

5.3 Buffer-Solution pH 2.9 – 3.3 to adjust the pH of wine

For example: 1 M KH₂PO₄ (Potassium dihydrogen phosphate, CAS 7778-77-0, 0.1 % TSP (3 - (trimethylsilyl) propionic acid sodium salt) (5.2),

3 mM NaN₃ (sodium azide, CAS 26628-22-8) in D₂O (5.1), pH 3.10

5.4 1 M hydrochloric acid, CAS 7647-01-0

5.5 1 M sodium hydroxide, CAS 1310-73-2

5.6 Buffer solutions for the calibration of electrodes

pH 4.00 and pH 2.00 (certified Reference Material, e. g. Certipur®)

5.7 Citric acid monohydrate, CAS 5949-29-1

5.8 Agua ultrapura, ISO 3696.

COMPENDIUM OF INTERNATIONAL ANALYSIS OF METHODS – OIV
Quantitation of glucose, malic acid, acetic acid, fumaric acid,
shikimic acid and sorbic acid in wine using quantitative nuclear
magnetic resonance spectrometry (1H NMR)

6. Apparatus

The membrane filters (6.8) must be free from the analytes to be determined.

6.1 5 mm NMR tubes, max. ± 1 % inner diameter deviation

6.2 Spinner with template for adjustment of NMR tubes

6.3 Device for pH measurement (± 0.01 pH units)

6.4 Automatic titration system (adjustment of the pH to ± 0.01 pH units);
alternativ manual adjustment

6.5 NMR spectrometer, for example, 400 MHz with 5 mm probe (z-Gradient) and
temperature stabilization ± 0.2 K

6.6 100 - 1000 μ l pipettes

6.7 1.5 ml reaction vials

6.8 Polyvinylidene Fluoride (PVDF) membrane filter, 0.2 μ m pore size, 15 mm
diameter

7. Sampling

Wine samples must be clear and have to be filtered (6.8) otherwise. For the sample preparation, wines are diluted with 10% buffer in D₂O. TSP is used as an internal standard for referencing the chemical shift to \square 0 ppm. The final pH of the sample solutions should be 3.10 ± 0.02 .

For example, 900 μ l of wine is mixed with 100 μ l buffer (5.3) and the pH adjusted exactly to 3.10 (± 0.02 pH units) with hydrochloric acid (5.4) or sodium hydroxide (5.5) in order to use the quantification parameters given in 11.1 Annex Table 1. For this purpose, suitable automatic titration systems or manual adjustment with a sensitive pH meter should be used. From this mixture 600 μ l is transferred in a 5 mm NMR tube and is directly measured.

COMPENDIUM OF INTERNATIONAL ANALYSIS OF METHODS – OIV
Quantitation of glucose, malic acid, acetic acid, fumaric acid,
shikimic acid and sorbic acid in wine using quantitative nuclear
magnetic resonance spectrometry (1H NMR)

8. Procedure

8.1 NMR Spectrometer and Measurement

The measurements have to be performed with water and ethanol multipresaturation suppression schemes. Several techniques for suppressing unwanted signals, such as selective multi-presaging and watergate, are available. To properly suppress the water signal, spectrometers are equipped with appropriate pulse sequences.

The signal-to-noise ratio of the selected signals for quantification of the analytes shall be more than 10:1.

In principle, the essential parameters are as follows:

- The recycling delay has to be at least 6 sec.
- The measurements have to be performed at 300 K (27 °C) with temperature stability of ± 0.2 K without rotation.
- Resolution equal or better 16 points/Hz
- The sweep width (SW) must be equal or greater than 18 ppm.
- The calibration and measurements of wine samples must be carried out under the same pulse angle.

8.2 Quantification of compounds

The quantification is performed on the recommended signal areas/intensities of the analytes (see 11.1 Annex Table 1). It can be done by internal or external (PULCON) standardization and calibration. The signals of appropriate analytes have to be assigned (see 11.1 Annex Table 1). Pure standards in comparable concentrations have to be measured under the same conditions as samples in order to obtain the additional response correction factor for the analyte in question (e.g. by spiking experiments). Suitable signals of the target substances are listed in 11.1 Annex Table 1.

9. Calculations

9.1 Calculation with internal standard

For the quantification, appropriate signals of analytes can be evaluated according to the following formula (internal standard):

**COMPENDIUM OF INTERNATIONAL ANALYSIS OF METHODS – OIV
Quantitation of glucose, malic acid, acetic acid, fumaric acid,
shikimic acid and sorbic acid in wine using quantitative nuclear
magnetic resonance spectrometry (1H NMR)**

$$m_x = \frac{MW_x}{MW_{std}} \cdot \frac{nH_{std}}{nH_x} \cdot \frac{A_x}{A_{std}} \cdot m_{std} \cdot CF$$

m_x and m_{std}	Masses of analyte and standard [g]
MW_x and MW_{std}	Molecular weights of analyte and standard [g/mol]
nH_x and nH_{std}	Numbers of protons of analyte and standard
A_x and A_{std}	Areas for the selected peaks of analyte and standard
x	Analyte
std	Reference standard, internal standard (e.g. TSP 5.2)
CF	Correction factor – see 11.1 Annex Table 1 (if needed, obtained by spiking experiments of the analyte in question)

9.2 Calculation with external standard, PULCON method

For the quantification, appropriate signals of analytes can be evaluated according to the PULCON method by the following formula F1. For quantification an external sample with known concentration of suitable substances for calibration is used each run, Quantref sample (citric acid 20 g/L). The resulting quantification factor is part of the data of each sample. The Quantref sample is used to calculate qf according to formula F2. The PULCON method is based on the following formula:

$$F. 1 \quad \gamma_{An} = \frac{I_{An} \cdot SW_{An} \cdot M_{An} \cdot P_{An} \cdot k_{An}}{SI_{An} \cdot qf \cdot P_{Ref} \cdot N_{H,An} \cdot d_{An}^2 \cdot NS_{An}}$$

with:

γ_{An} = searched analyte mass concentration (in mg/L)

I_{An} = absolute integral of analyte in sample

SW_{An} = spectral width (e.g. 20.55 ppm)

M_{An} = molar mass of the analyte (g/mol)

P_{An} = excitation pulse length used for the sample (in μ s)

k_{An} = correction factor (if needed, obtained by spiking experiments of the analyte in question)

SI_{An} = Size (e.g. 131072)

qf = mean value quantification factor from QuantRef

**COMPENDIUM OF INTERNATIONAL ANALYSIS OF METHODS – OIV
Quantitation of glucose, malic acid, acetic acid, fumaric acid,
shikimic acid and sorbic acid in wine using quantitative nuclear
magnetic resonance spectrometry (1H NMR)**

P_{Ref} = excitation pulse length used for the QuantRef (in μs)
 $N_{H, An}$ = number of protons per analyte molecule giving this resonance
 d_{An} = inner diameter of the analyte tube
 NS_{An} = number of acquired FIDs for the analyte tube

$$F. 2 \quad qf = \frac{I_{Ref} \cdot SW_{Ref} \cdot M_{Ref}}{SI_{Ref} \cdot \gamma_{Ref} \cdot N_{H,Ref} \cdot d_{Ref}^2 \cdot NS_{Ref}} \left(\text{in } \frac{\text{a. u.} \cdot \text{ppm} \cdot \text{l}}{\text{mol}} \right)$$

With:

I_{Ref} = absolute integral of the reference signal
 SW_{Ref} = spectral width (e.g. 20.55 ppm)
 M_{Ref} = molar mass of the reference substance (g/mol)
 SI_{Ref} = size (e.g. 131072 = 128k = 2^{17})
 γ_{Ref} = mass concentration of the reference substance
 $N_{H, Ref}$ = number of protons per reference molecule giving this resonance
 d_{Ref} = inner diameter of sample tube for the reference tube
 NS_{Ref} = number of acquired FIDs for the reference tube

Furthermore, it is mandatory to acquire both reference and analyte spectra respectively with the same setting for receiver sensitivity (receiver gain). It is also advisable to keep all measurement parameters the same (temperature, the type of sample tube, SI, SW, NS) when determining qf or y_{An} respectively.

9.3 Expression of results

Results should be expressed in mg/L with one decimal for minor constituents (<1 g/L) and without decimals for major constituents (>1 g/L).

10. Precision

A ring trial was conducted to provide a realistic indication of the method performance. Details are given in Godelmann et al. 2016.

10.1 Repeatability and reproducibility

Table 1 summarizes the relative standard deviations of the repeatability and reproducibility for the different analytes (Godelmann et al. 2016).

COMPENDIUM OF INTERNATIONAL ANALYSIS OF METHODS – OIV
Quantitation of glucose, malic acid, acetic acid, fumaric acid,
shikimic acid and sorbic acid in wine using quantitative nuclear
magnetic resonance spectrometry (1H NMR)

Table 1: Relative standard deviations of the repeatability and reproducibility, taken from the proficiency test (Godelmann et al. 2016) for the different analytes.

	Glucose	Malic acid	Acetic acid	Fumaric acid	Shikimic acid	Sorbic acid
NMRP01 (Model wine)						
Number of laboratories	15	14	15	14	13	14
Mean mg/L	9903	2628	1056	82.1	103.6	126.1*
RSDr %	1.5	1.7	1.4	1.5	1.8	7.5
RSDR %	5.5	4.3	7.5	12.5	5	11.9
NMRP02 (white wine)						
Number of laboratories	15	14	15	14	13	15
Mean mg/L	28304	3528	868	12.1 (<LOQ)	45.8	164.6
RSDr %	1.3	1.7	1.6		4	2.1
RSDR %	4.6	14.3	9		18.3	5.1
NMRP03 (red wine)						
Number of laboratories	14	9	14	13	13	14
Mean mg/L	11505	240 (<LOQ)	544	29.1	34.6	149.7
RSDr %	2.2		3.6	3.1	14.7	2.7
RSDR %	4.3		7.6	9.1	20	5.4
NMRP04 (red wine)						
Number of laboratories	14	11	14		13	5
Mean mg/L	12538	251	627	n.d.	61.8	10.9 (<LOQ)
RSDr %	1.7	6.6	2.7		9.4	
RSDR %	3.9	11.4	5.8		15.3	
NMRP05 (white wine)						
Number of laboratories	14	13	14	13	13	15
Mean mg/L	30303	2615	1011	27.1	29.3	191.8
RSDr %	3.2	4.6	2.7	3	8.8	3.9
RSDR %	5	13.7	7	5.3	15.6	7
NMRP06 (red wine)						
Number of laboratories	14	11	14	4	12	14
Mean mg/L	6090	267	630	n.d.	30	158.5
RSDr %	3	6.1	2.1		9.6	4.3
RSDR %	5.3	10.2	4.9		12.6	6.3
NMRP07 (white wine)						
Number of laboratories	13	10	14	14	13	4
Mean mg/L	5297	8036	794	n.d.	36.2	3.2 (<LOQ)
RSDr %	1.5	3.7	2.6		11.5	
RSDR %	6.3	5.9	7.4		14.7	
NMRP08 (white wine)						
Number of laboratories	14	14	14	13	13	6
Mean mg/L	16518	5254	301	n.d.	68.4	5.4 (<LOQ)
RSDr %	1	2.2	3		4.2	
RSDR %	4.5	8.6	7.1		6.4	

**COMPENDIUM OF INTERNATIONAL ANALYSIS OF METHODS – OIV
Quantitation of glucose, malic acid, acetic acid, fumaric acid,
shikimic acid and sorbic acid in wine using quantitative nuclear
magnetic resonance spectrometry (1H NMR)**

NMRP09 (white wine)						
Number of laboratories	14	12	14	14	13	15
Mean mg/L	2091	2390	176	45.9	44.1	98
RSDr %	3.1	2.6	4.6	2.2	4.3	1.8
RSDR %	6.6	5.7	12	4.6	8.4	5.1
NMRP10 (red wine)						
Number of laboratories	9	7	14	15	13	15
Mean mg/L	442 (<LOQ)	178 (<LOQ)	502	90.6	58	200.3
RSDr %			2.4	2.5	5.2	2.9
RSDR %			11.7	7.7	16.4	6.8

10.2 Limit of detection and limit of quantification

The limit of detection (LOD) and the limit of quantification (LOQ) need to be estimated individually by the laboratories and depend on the NMR system used (particularly on the field strength). Nevertheless to give an indication the LODs and LOQs listed in Table 2 were calculated according to the instructions of the resolution OENO 7-2000 (E-AS1-10-LIMDET) on basis of sample preparation and parameters of NMR measurement previously (400 MHz, and using ethanol suppression).

Table 2: Limit of detection and limit of quantification

Analyte	LOD mg/L	LOQ mg/L
Glucose	150	600
Malic acid	90	300
Acetic acid	10	30
Fumaric acid	5	20
Shikimic acid	5	20
Sorbic acid	5	20

COMPENDIUM OF INTERNATIONAL ANALYSIS OF METHODS – OIV
Quantitation of glucose, malic acid, acetic acid, fumaric acid, shikimic acid and sorbic acid in wine using quantitative nuclear magnetic resonance spectrometry (1H NMR)

11. Annex

11.1 Table 1 Quantification Parameters, according 400 MHz, pH 3.10

Analyte	Molarity (g/mol)	Signal used for Quantification	n of Protons	Description	Typical Region (example) ppm	Correction Factor	Comment for Correction
Malic Acid	134	H3B, 4 Signals @ approx. 2.88ppm	1	Region: Left Signal + 4.5Hz, Right Signal - 4.5Hz Local Baseline-Correction	2.8465-2.9216	1.05	Due to truncated region
Sorbic Acid	112	Half of H2, Left signal of Doublet @ approx. 5.85 ppm	0.5	Region: Left Signal of Doublet ± 7Hz Local Baseline-Correction	5.8250-5.8600	0.95	Due to roof-effect of doublet
Fumaric Acid	116	H2+H3, Singlet @ approx. 6.75 ppm	2	Region: Signal ± 3Hz Local Baseline-Correction (zero/first order)	6.7350-6.7600	1.00	-
Acetic Acid	60	H2A + H2B + H2C, Singlet @ approx. 2.07 ppm	3	Region: Signal ± 3Hz Local Baseline-Correction (zero order)	2.0720-2.0830	1.28 (combined factor)	Due to T1 (factor 1.16) and truncated region (factor 1.1)
Glucose	180	H1-alpha, Doublet @ approx. 5.21 ppm	1	Region: Center of Doublet ± 5Hz Local Baseline-Correction (zero order)	5.1900-5.2300	2.50 (combined factor)	alpha/beta-glucose (factor 2.33), truncated region (factor 1.07)
Shikimic Acid	174	H2, Higher Order (5) @ approx. 6.8 ppm	1	Region: Center of Multiplet ± 6Hz Local Baseline-Correction (zero/first order)	6.7850-6.8200	1.00	-

**COMPENDIUM OF INTERNATIONAL ANALYSIS OF METHODS – OIV
Quantitation of glucose, malic acid, acetic acid, fumaric acid, shikimic acid and
sorbic acid in wine using quantitative nuclear magnetic resonance
spectrometry (1H NMR)**

11.2 Trueness/Recovery

The recovery was determined for the ring test samples by comparing the mean values of the NMR method with respective analysis of the relevant parameter by the OIV method (for acetic acid enzymatic/HPLC methods and fumaric acid HPLC method were used)

The calculated recoveries are for glucose 100.3 % (n=9, 95.2 – 106.4), for acetic acid 108.9 % (n=10, 99.9 – 123), for malic acid 104.1 % (n=7, 91.4 – 124.1), for shikimic acid 105.2 % (n=10, 91.2 – 122.3), for sorbic acid 100.2 % (n=8, 97.9 – 102.5) and for fumaric acid 96.8 % (n=6, 80.5 – 104.1). Only for the parameter acetic acid were yielded always findings of above

100% with a total mean of 109%. For these findings, the correction factor of 1.28 could be the reason – see 11.1 Annex Table 1. The recoveries are calculated on the basis of analysis of reference values originating from OIV methods.

Table 2 Recoveries of analytes

Analyte	Mean recovery % n: number of ring test samples calculated	Variation %
Glucose	100.0 (n=9)	95.2 – 106.4
Malic acid	104.1 (n=7)	91.4 – 124.1
Acetic acid	108.9 (n=10)	99.9 – 123
Fumaric acid	96.8 (n=6)	80.5 – 104.1
Shikimic acid	105.2 (n=10)	91.2 – 122.3
Sorbic acid	100.2 (n=8)	97.9 – 102.5

11.3 Horrat values of all compounds

Table 4

Parameter	Horrat-Value			Samples
	0,5 – 1,5	1,6 – 2,0	> 2,0	
				<LOQ
Acetic Acid	7 (0,8 – 1,3)	3 (1,6; 1,6; 1,9)	0	0
Malic Acid	4 (0,9 – 1,5)	2 (1,6; 2,0)	2 (2,8; 3,1)	2
Glucose	9 (1,0 – 1,5)	0	0	1
Sorbic Acid	7 (0,6 – 1,5)	0	0	3
Fumaric Acid	6 (0,5 - 1,5)	0	0	4
Shikimic Acid	4 (0,6 – 1,3)	5 (1,6; 1,6; 1,8; 1,9; 2,0)	1 (2,1)	0

**COMPENDIUM OF INTERNATIONAL ANALYSIS OF METHODS –
OIV**

**Quantitation of glucose, malic acid, acetic acid, fumaric acid,
shikimic acid and sorbic acid in wine using quantitative nuclear
magnetic resonance spectrometry (1H NMR)**

11.4 Example for an NMR spectra

Figure 1. NMR spectra of model wine with selected signals for quantification

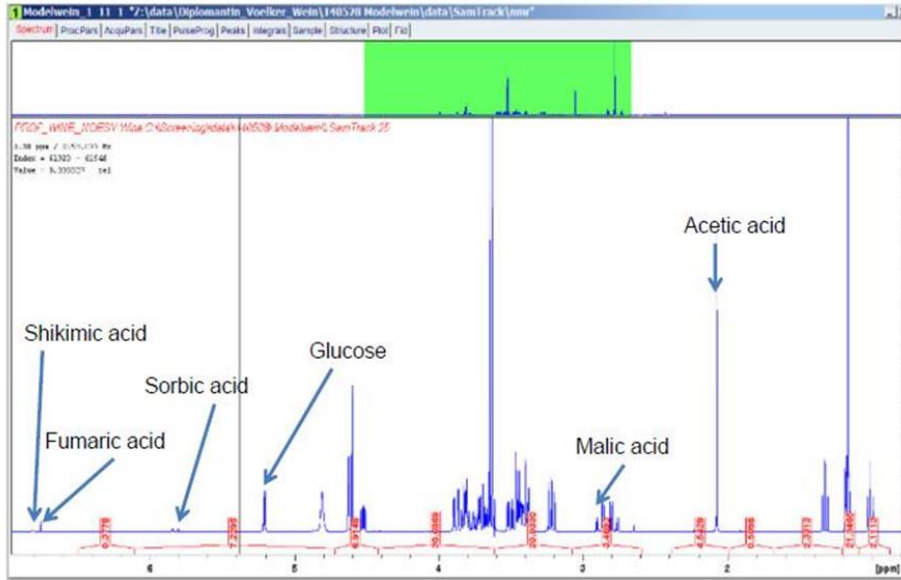

**COMPENDIUM OF INTERNATIONAL ANALYSIS OF METHODS –
OIV**

**Quantitation of glucose, malic acid, acetic acid, fumaric acid,
shikimic acid and sorbic acid in wine using quantitative nuclear
magnetic resonance spectrometry (1H NMR)**

12. Literature

1. Godelmann R., Fang Fang, Humpfer E., Schütz B., Bansbach M., Schäfer H., Spraul M., (2013), Targeted and Nontargeted Wine Analysis by 1H NMR Spectroscopy Combined with Multivariate Statistical Analysis. Differentiation of Important Parameters: Grape Variety, Geographical Origin, Year of Vintage, *J. Agric. Food Chem.* 61, 5610–5619
2. Monakhova Y.B., Schäfer H., Humpfer E., Spraul M., Kuballa T., Lachenmeier D., (2011), Application of automated eightfold suppression of water and ethanol signals in 1H NMR to provide sensitivity for analyzing alcoholic beverages, *Magn. Reson. Chem.* 49,734-739
3. G. Wider, L. Dreier: Measuring Protein Concentrations by NMR Spectroscopy, *J. Am. Chem. Soc.* 2006, 128, 2571-2576
4. Godelmann R., Kost C., Patz C., Ristow R., Wachter H., (2016), Quantitation of compounds in wine using 1H NMR spectroscopy – Description of the method and collaborative study, *Journal of AOAC International* Vol. 99, No. 5, 1295-1304
5. Horwitz W. (1995) Protocol for the design, conduct and interpretation of method- performance studies, *Pure and Applied Chemistry* 67, 331-343
6. Horwitz, W. (1982) *Anal. Chem.* 54, 67A-76A
7. Peeler, J.T., Horwitz W., & Albert R. (1989) *J. Assoc. Off. Anal. Chem.* 72, 784-806
8. Herbert-Pucheta, J.E., Mejía-Fonseca, I., Zepeda-Vallejo, L.G., Milmo-Brittingham, D., Maya, G.P. The “Wine-T1” NMR experiment of novel wine-metabolome fingerprinting with nuclear-spin relaxation DOI: 10.1051/bioconf/20191202029
9. Herbert-Pucheta, J.E., Pino-Villar, C., Rodríguez, González, F., Padilla-Mata, G., Milmo-Brittingham, D., Zepeda-Vallejo, L.G. “One-shot” analysis of wine parameters in non-Saccharomyces large-scale alcohol reduction processes with one- and two-dimensional nuclear magnetic resonance, DOI: 10.1051/bioconf/20191502016
10. Resolución OENO 7-2000 (E-AS1-10-LIMDET), “Estimación del límite de detección y de cuantificación de un método de análisis”
11. ISO 3696.

Total Bromide

1. Principle

The wine is ashed at 525 °C in presence of an excess of soda lime. A solution of the residue (at pH 4.65) is treated with chloramine T to liberate bromide. The bromide is reacted with phenolsulfonephthalein to form phenoltetra-bromophthalein-3',3''-disulfonic acid, which is determined by spectrophotometer at 590 nm.

2. Apparatus

- 2.1 Boiling water-bath 100°C
- 2.2 Temperature-controlled electric furnace
- 2.3 Spectrophotometer capable of measuring absorbance at wavelengths between 300 and 700 nm

3. Reagents

- 3.1 Sodium hydroxide solution, 50% (*m/m*)
- 3.2 Calcium hydroxide suspension containing 120 g of CaO per liter
- 3.3 Phenolsulfonephthalein solution:
0.24 g of phenolsulfonephthalein (phenol red) are dissolved in 24 mL sodium hydroxide solution, 0.1 M, and made up to the liter with distilled water.
- 3.4 pH 4.65 buffer solution:

Acetic acid, 2 M	500 mL
Sodium hydroxide, 2 M	250 mL
Distilled water to	1 L
- 3.5 Oxidizing solution:

Chloramine T	2 g
Distilled water to	1 L

Prepare this solution 48 hours before use
Storage: two weeks at ± 4 °C
- 3.6 Reducing solution:

Sodium thiosulfate	25 g/L.
Distilled water to	1 L
- 3.7 Sulfuric acid, 10%(v/v): sulfuric acid ($\rho_{20} = 1.84$ g/mL) diluted 1/10.
- 3.8 Sulfuric acid, 1%(v/v): sulfuric acid ($\rho_{20} = 1.84$ g/mL) diluted 1/100.
- 3.9 Potassium bromide solution corresponding to 1 g of bromide per liter. 1.489g of potassium bromide, KBr, is dissolved in distilled water and made up to one liter.

4. Procedure

4.1 How to obtain ash and ash solution

Place 50 mL of wine in a silica dish of 7 cm diameter, add 0.5 mL 50% sodium hydroxide solution, (3.1), and 1 mL calcium hydroxide suspension (3.2). Check that the pH is at least pH 10. Leave the dish covered with a watch glass for 24 hours. Evaporate the liquid until dry on a boiling water bath. To accelerate the evaporation, a hot air current can be used in the final stages.

Ash as follows: place the dish 30 minutes in a furnace (2.2) at 525°C. After cooling, mix the residue with a little distilled water. Evaporate on the boiling water-bath. Ash again at 525°C. Repeat the operation until the ash is gray/white.

Mix the residue with 5 mL boiling distilled water. Add using a burette: first 10% sulfuric acid (3.7), then sufficient 1% sulfuric acid (3.8) to bring the pH to between 4 and 5 as measured by indicator paper. Let X mL = the volume added of sulfuric acid (3.7 & 3.8). Add 10.2-(X+5) mL of distilled water. Crush the precipitated calcium sulfate with a glass rod. Transfer the content of the dish to a centrifugation tube. Centrifuge for 10 min. Place 8 to 9 mL of the clear supernatant into a test tube.

4.2 Qualitative test

This test is performed to determine if the bromide content of the wine is between 0 and 1 mg/L, which would enable the determination to be performed on the undiluted ash solution.

Place in a small test tube:

- 1 mL of ash solution
- 1 drop of pH 4.65 buffer solution
- 1 drop of phenolsulfonephthalein solution
- 1 drop of chloramine T solution

After exactly 1 minute, stop the reaction by adding 1 drop of sodium thiosulfate solution.

If the coloration obtained is yellow, brownish yellow or greenish yellow, the ash solution can be used undiluted.

If the obtained coloration is blue, purple or violet, the wine contains more than 1 mg of bromide per liter and the ash solution must be diluted 1/12 or 1/5 until the coloration obtained corresponds to the conditions above.

4.3 Quantitative method

Place in a test tube:

- 5 mL of ash solution, diluted or undiluted, add:
- 0.25 mL of pH 4.65 buffer solution
- 0.25 mL of phenolsulfonephthalein solution
- 0.25 mL T chloramine solution

Wait exactly 1 minute and add:

- 0.25 mL of sodium thiosulfate

Measure using a spectrophotometer set at 590 nm with a 1 cm cell, the difference in absorbance between the sample and the blank obtained by adding the same quantities of reagents to 5 mL of distilled water.

Note: When the bromide content is low (yellow coloration, slightly greenish) determine the absorbance in a cell of 2 cm optical path.

4.4 *Preparation of the calibration curve*

At the time of use, prepare a solution containing 10 mg of bromine per liter by making 2 successive dilutions (1/10) of standard potassium bromide solution, 1 g/L.

In a set of 8 test tubes, place 0.25, 0.50, 0.75, 1.00, 1.25, 1.50, 2.00 and 2.50 mL respectively of bromide standard, 1g/L (3.9) and make up to 5 mL with distilled water. (The solutions are equivalent to 0.10, 0.20, 0.30, 0.40, 0.50, 0.60, 0.80 and 1 mg of bromine per liter of wine without dilution of the ash solution). Continue as in 4.3 using the calibration solutions instead of the ash solution. Determine the absorbance of these solutions and a blank, as in 4.3, using 5 mL of distilled water in the blank solution. The absorbance obtained corresponding to the bromide concentration is plotted on a line that curves slightly towards the origin.

5. Expression of results

5.1 *Calculations*

The bromide content in wine is obtained by plotting on the calibration curve, the net absorbance of the ash solution (taking into account the thickness of the cell used and any dilution of the ash solution) and interpolating the bromide concentration. The total bromide content is expressed in milligrams per liter (mg/L) to two decimal places.

BIBLIOGRAPHY

- DAMIENS A., *Bull. Sci. Pharmacologiques*, 1920, **27**, 609; *Ibid*, 1921, **28**, 37, 85 et 105.
BALANTRE P., *J. Pharm. Chem.*, 1936, **24**, 409.
PERRONET M., ROCQUES Mme S., *Ann. Fals. Fraudes*, 1952, **45**, 347.
CABANIS J.-C., *Le brome dans les vins*, Thèse doct. Pharm., Montpellier, 1962.
JAULMES P., BRUN Mme S., Cabanis J.-C., *Chim anal.*, 1962, 327.
STELLA C., *Riv. Viticolt. Enol.*, Conegliano, 1967, 5.

Chloride

1. Principle

Chloride is determined directly in the wine by potentiometry using an Ag/AgCl electrode.

2. Apparatus

- 2.1 pH/mV meter graduated at intervals of at least 2 mV.
- 2.2 Magnetic stirrer.
- 2.3 Ag/AgCl electrode with a saturated solution of potassium nitrate as electrolyte.
- 2.4 Microburette graduated in 0.01 mL.
- 2.5 Chronometer.

3. Reagents

- 3.1 Standard chloride solution: 2.1027 g of potassium chloride, KCl (max. 0.005% Br), dried before use, by leaving in a desiccator for several days, is dissolved in distilled water and made up to one liter. 1 mL of this solution contains 1 mg Cl⁻.
- 3.2 Silver nitrate solution: 4.7912 g of analytical grade silver nitrate, AgNO₃, is dissolved in ethanol solution, 10% (v/v) and made up to one liter. 1 mL of this solution corresponds to 1 mg Cl⁻.
- 3.3 Nitric acid, not less than 65% ($\rho_{20} = 1.40$ g/mL).

4. Procedure

- 4.1 Place 5.0 mL of standard chloride solution (3.1) into a 150 mL cylindrical vessel placed on a magnetic stirrer (2.2), dilute with distilled water to approximately 100 mL and acidify with 1.0 mL of nitric acid (3.3). After immersing the electrode, add silver nitrate solution (3.2) with the microburette, with moderate stirring using the following procedure: begin by adding the first 4 mL in 1 mL fractions and read the corresponding millivolt values. Add the next 2 mL in fractions of 0.20 mL. Finally, continue the addition in fractions of 1 mL until a total of 10 mL has been added. After each addition, wait for approximately 30 sec before reading the corresponding millivolt value. Plot the values obtained on a graph against the corresponding milliliters of titrant and determine the potential corresponding to the equivalence point.

- 4.2 Place 5 mL of the standard chloride solution (3.1) in a 150 mL cylindrical vessel with 95 mL of distilled water and 1 mL of nitric acid (3.3). Immerse the electrode and titrate, while stirring, until the potential of the equivalence point is obtained. This determination is repeated until a good degree of agreement in the results is obtained. This check must be carried out before each series of measurements of chloride in the samples.
- 4.3 Place 50 mL of wine into a 150 mL cylindrical vessel. Add 50 mL of distilled water and 1 mL of nitric acid (3.3) and titrate using the procedure described in 4.2.

5 Expression of results

5.1 Calculations

If n represents the number of milliliter of silver nitrate titrant, the chloride content in the tested liquid, is given by:

$20 \times n$ expressed as milligrams Cl per liter

$0.5633 \times n$ expressed as milliequivalents per liter,

$32.9 \times n$ expressed as milligrams of NaCl per liter.

- 5.2 *Repeatability (r)*: $r = 1.2 \text{ mg Cl/L}$
 $r = 0.03 \text{ mEq/L}$
 $r = 2.0 \text{ mg NaCl/L}$

- 5.3 *Reproducibility (R)* $R = 4.1 \text{ mg/L}$
 $R = 0.12 \text{ mEq/L}$
 $R = 6.8 \text{ mg NaCl/L}$

6. Note: For very precise determination.

Refer to the complete titration curve obtained during determination of the test liquid (4.2).

- a) Measure 50 mL of the wine to be analyzed into a 150 mL cylindrical vessel. Add 50 mL of distilled water and 1 mL of nitric acid (3.3). Titrate using silver nitrate solution (3.2), adding 0.5 mL at a time and recording the corresponding potential in millivolts. Estimate from this first titration the approximate volume of silver nitrate solution (3.2) required.
- b) Repeat the determination adding 0.5 mL of titrant at a time until the volume added is 1.5 to 2 mL less than the volume determined in (a). Thereafter add 0.2 mL at a time. Continue to add the solution beyond the estimated equivalence point in a symmetrical manner, i.e. by adding 0.2 mL and then 0.5 mL at a time.

The end point of the measurement and the exact volume of silver nitrate consumed are obtained:

- either by drawing the curve and determining the equivalence point;
- or by the following calculation:

**COMPENDIUM OF INTERNATIONAL METHODS OF ANALYSIS - OIV
Chloride**

$$V = V' + \Delta V_i \frac{\Delta \Delta E_1}{\Delta \Delta E_1 + \Delta \Delta E_2}$$

Where:

V = volume of titrant at the equivalence point;

V' = volume of titrant before the largest potential change;

ΔV_i = constant volume of the increments of titrant, i.e. 0.2 mL;

ΔE_1 = second difference in potential before the largest potential change;

ΔE_2 = second difference in potential after the largest potential change.

Example:

Volume of AgNO ₃ titrating solution	E potential in mV	Difference ΔE	Second difference $\Delta \Delta E$
0	204	4	
0.2	208	4	0
0.4	212	6	2
0.6	218	6	0
0.8	224	6	0
1.0	230	6	2
1.2	238	8	4
1.4	250	12	10
1.6	272	22	22
1.8	316	44	10
2.0	350	34	8
2.2	376	26	6
2.4	396	20	

In this example, the end point of the titration is between 1.6 and 1.8 mL: the largest potential change ($\Delta E = 44$ mV) occurs in this interval. The volume of silver nitrate titrant consumed to measure the chlorides in the test sample is:

$$V = 1.6 + 0.2 \frac{22}{22+10} = 1.74 \text{ mL}$$

BIBLIOGRAPHY

MIRANDA PATO C. de, *F.V., O.I.V.*, 1959, n°12.

HUBACH C.E., *J. Ass. Off. Agric. Chem.*, 1966, **49**, 498.

Fédération internationale des Producteurs de jus de fruits, *F. O.I.V.*, 1968, n°37.

JUNGE Ch., *F.V., O.I.V.*, 1973, n°440.

Method OIV-MA-AS321-03

Type II method

**Determination of fluoride content in wine using a fluoride
selective ion electrode, and a standard addition method**

(Resolution Oeno 22/2004)

1. SCOPE

This method is applicable to the analysis of fluoride in all wines. With proper dilution, the range of detection is 0.1 mg/l to 10.0 mg/l.

2. PRINCIPLE

The concentration of fluoride in the sample is measured after addition of a buffer, using a fluoride ion selective electrode. The buffer provides a high, constant background ionic strength; complexes iron and aluminium (which would otherwise complex with fluoride); and adjusts the pH to a level that minimises the formation of a HF•HF complex. The matrix effects are then minimised using standard addition.

3. REAGENTS

3.1 Deionized or distilled water

3.2 Sodium chloride ≥ 99.0% purity

3.3 Trisodic citrate ≥ 99.0% purity

3.4 CDTA (1,2-diaminocyclohexane-N,N,N',N'- tetracetic hydrate acid) ≥ 98.0% purity

3.5 Sodium hydroxide ≥ to 98.0% purity

3.6 Sodium hydroxide solution 32% (w/v) made from 3.5

3.7 Glacial acetic acid ≥ 99.0% purity

3.8 Sodium fluoride ≥ 99.0% purity

3.9 Commercial Total Ionic Strength Adjustment Buffer (TISAB) (i.e. III-Orion Research Inc. Cat. # 940911) or equivalent (See 4.2).

3.10 Alternative TISAB:

3.10.1 To ca. 700 ml water (3.1) in a 1 l beaker (4.3), add 58.0 g \pm 0.1 g sodium chloride (3.2) and 29.4 g \pm 0.1 g of tri-sodium citrate (3.3).

3.10.2 Dissolve 10.0 g \pm 0.1 g of CDTA (1,2-diaminocyclohexane-N,N,N',N'-tetraacetic acid) (3.4) and 6 ml of 32% (w/v) sodium hydroxide (3.6) in approximately 50 ml of distilled water. (3.1)

3.10.3 Mix the two solutions together then add 57 ml of glacial acetic acid (3.7) and adjust pH to 5.5 with 32% (m/v) sodium hydroxide (3.6). Cool to room temperature, transfer to 1 l volumetric flask (4.10), and dilute to volume with water (3.1).

3.11 Fluoride standard solutions

3.11.1 Fluoride stock standard solution (100 mg/l):
Weigh 221 mg \pm 1 mg of sodium fluoride (3.8) (dried at 105°C for 4 hours) into a 1 l polyethylene volumetric flask (4.10) and make to volume with water. (3.1)

3.11.2 Fluoride calibration standards at 1.0 mg/l, 2.0 mg/l and 5.0 mg/l : make 1.0 mg/l, 2.0 mg/l, and 5.0 mg/l calibration standards by pipetting 1 ml, 2 ml, and 5 ml of the 100 mg/l stock standard (3.11.1) into three polyethylene 100 ml volumetric flasks (4.10) respectively and diluting to volume with water (3.1).

3.12 Wine blank : a wine known to be fluoride free is used as a matrix blank

3.13 1 mg/l spiked wine standard - Place 10 ml (4.11) of 100 mg/l fluoride stock standard solution(3.11.1)into a 1 l volumetric flask (4.10) and bring to volume with fluoride free wine (3.12).

4. APPARATUS

- 4.1 pH/ion analyser with standard addition capability (e.g. Corning pH/ion Analyser 455, Cat. # 475344) or pH/ion analyser with extended mV range.
- 4.2 Fluoride ion selective electrode and single junction reference electrode or combination electrode (e.g., Corning Fluoride Electrode Cat. # 34108-490).
- 4.3 Beakers - 150 ml, 1 l, polyethylene
- 4.4 **Cylinder** - 50 ml graduated, polyethylene, pouring.
- 4.5 Magnetic stirrer
- 4.6 Magnetic stir bars, PTFE coated.
- 4.7 Plastic bottles with caps, 125 ml (Nalgene or equivalent)
- 4.8 Precision pipette, 500 µl
- 4.9 Ultrasonic bath
- 4.10 Volumetric flasks, Class A, 50 ml, 100 ml, and 1 l
- 4.11 Volumetric pipettes, Class A, 1 ml, 2ml, 5 ml, 10 ml, 20 ml, and 25 ml

5. PREPARATION OF CALIBRATION STANDARDS

5.1 Place 25 ml (4.11) of 1.0 mg/l, 2.0 mg/l, and 5.0 mg/l standard solutions (3.11.2) respectively into three 150 ml beakers (4.3), add 20 ml (4.11) of water (3.1) and (4.11) 5 ml of commercial TISAB (3.9) to each. Mix with a magnetic stirring. (4.5 and 4.6).

5.2 If using alternative TISAB reagent (3.10) : place 25 ml (4.11) of each standard solution (3.11.2) into three 150 ml beakers (4.3) and add 25 ml (4.11) of alternative TISAB reagent (3.10) to each. Mix with a magnetic stirrer. (4.5 and 4.6)

6. PREPARATION OF THE TEST SAMPLES

Mix the wine sample thoroughly before sampling. Sparkling wines should be degassed before sampling by transferring to a clean beaker and placing in an ultrasonic bath (4.9) until gas no longer evolves.

6.1 If using reagent (3.9), commercial TISAB : place 25 ml (4.11) of wine sample into a 150 ml beaker (4.3) with 20 ml (4.11) of water (3.1) and add 5 ml (4.11) of commercial TISAB (3.9) solution. Mix with a magnetic stirrer (4.5 and 4.6). Dilution factor (DF) = 1.

6.2 If using alternative TISAB reagent (3.10) : place 25 ml (4.11) of wine sample in a 150 ml beaker (4.3) and add 25 ml (4.11) of alternative TISAB reagent (3.10). Mix with a magnetic stirrer (4.5 and 4.6). Dilution factor (DF) = 1.

7. PROCEDURE

Measurement (all standard and wine sample solutions must be at the same temperature).

7.1 Calibration standards

Measure the potential of each of the calibration solutions, using the meter (4.1), fluoride selective electrode (4.2), and reference electrode (4.2). The final reading must be taken when the readings have stabilised (stability is obtained when the potential varies by not more than 0.2 to 0.3 mV/ 3 minutes). Record the readings for each of the calibration standards.

The \log_{10} of each of the standard concentrations versus the millivolt reading measured for each standard concentration is plotted on graph paper in order to determine the slope of the electrode.

7.2 Wine samples

Measure and record the potential expressed in mV (E1) of the sample (6.1 or 6.2) after the readings have stabilised. Add 500 μ l (4.8) of 100 mg/l fluoride standard (3.11.1) to the sample (6.1 or 6.2). After the readings have stabilised, read and record the potential expressed in mV (E2) of the wine solution.

The final concentration must be at least double the fluoride concentration in the sample solution. To make sure, if the fluoride concentration in the test sample is above 2 mg/l on the first determination, a second determination must be made after dilution of the sample as follows (7.2.1 or 7.2.2).

7.2.1 When using the commercial TISAB buffer (3.9): pipette (4.11) 25 ml of wine sample in a 50 ml volumetric flask (4.10) and bring to volume with water. Take 25 ml (4.11) of this diluted wine in a 150 ml cylindrical beaker (4.3) and add 25 ml of commercial TISAB (3.9). Mix with a magnetic stirrer (4.5 and 4.6) and then proceed with measurement as in 7.02. Dilution factor (DF) = 2.

7.2.2 When using the alternative TISAB buffer (3.9): pipette (4.11) 25 ml of wine sample in a 50 ml volumetric flask (4.10) and bring to volume with water. Pour 25 ml (4.11) of this diluted wine in a 150 ml cylindrical beaker (4.3) and add 25 ml of alternative TISAB buffer (3.10). Mix with a magnetic stirrer (4.5 and 4.6) and then proceed with measurement as in 7.2. Dilution factor: (DF) = 2.

8 CALCULATION

The fluoride content of the sample solution expressed in mg/l is obtained by using the following formula:

$$C_f = \frac{V_a \times C_a}{V_o} \times \frac{1}{((\text{anti log } \Delta E / S) - 1)}$$

If the added standard solution V_{std} is < 1% of the volume of the solution after the addition, so $V_a = V_o$ and

$$C_f = DF \times C_a \times \frac{1}{((\text{anti log } \Delta E / S) - 1)}$$

C_f = fluoride concentration of the sample solution (mg/l)

DF = dilution factor. If it is necessary to dilute the sample as in (7.2.1) or in (7.2.2), use the identical values for the dilution and the sample. That is to say, DF = 2 for a diluted sample (7.2.1) and (7.2.2) or DF = 1 if it is not as in (6.1) or (6.2)

V_o = initial volume of the sample solution before standard addition (ml)

V_a = volume of the solution after standard addition (ml)

ΔE = difference between potentials E1 and E2 obtained in (7.2) in mV.

S = slope of the calibration curve of the electrode.

$$C_a = \frac{V_{std} \times C_{std}}{V_{samp}}$$

where

C_a = concentration (in mg/l) of fluoride added to the sample volume (V_o) obtained by multiplying the standard volume (3.11.1) added to the solution (V_{std}) by the concentration (C_{std}) of standard (3.11.1) and divided by the sample volume (25 ml) using (6.1) or (6.2)

V_{std} = volume added standard (3.11.1) (0.5 ml)

V_{samp} = sample volume used in (6.1) or (6.2), $V_{samp} = 25$ ml

C_{std} = standard concentration (3.11.1)

Calculation example:

(1) for a sample prepared as in (6.2) and measured as in (7.2)

$DF = 1$

$$C_a = \frac{V_{std} \times C_{std}}{V_{samp}} = \frac{0.5 \text{ ml} \times 100 \text{ mg/l}}{25 \text{ ml}} = 2 \text{ mg/l}$$

$\Delta E = 19.6$ mV

$S = -58.342$

$$C_f = DF \times C_a \times \frac{1}{((\text{anti log } \Delta E / S) - 1)}$$

$$C_f = 1 \times 2 \text{ mg/l} \times \frac{1}{((\text{anti log } 19.6 / 58.342) - 1)}$$

$$C_f = 1 \times 2 \text{ mg/l} \times 0.856 = 1.71 \text{ mg/l of fluoride}$$

(2) for a sample prepared as in (7.2.2), and measured as in (7.2)
 $DF = 2$

$$C_a = \frac{V_{std} \times C_{std}}{V_{samp}} = \frac{0.5 \text{ ml} \times 100 \text{ mg/l}}{25 \text{ ml}} = 2 \text{ mg/l}$$

$$\Delta E = 20.4 \text{ mV}$$

$$S = -55.937$$

$$C_f = DF \times C_a \times \frac{1}{((\text{anti log } \Delta E / S) - 1)}$$

$$C_f = 2 \times 2 \text{ mg/L} \times \frac{1}{((\text{anti log } 20.4 / 55.937) - 1)}$$

$$C_f = 2 \times 2 \text{ mg/l} \times 0.760 = 3.04 \text{ mg/l of fluoride}$$

9. PRECISION

The details of inter laboratory study are given in Annex B. the Horrat (Ho_R) ranges from 0.30 to 0.97 and indicates a very good reproducibility among participants.

The results of the statistical calculations are given in Annex B table 2.

The standard deviation of repeatability (RDS_r) ranges from 1.94% to 4.88%. The standard deviation of reproducibility (RDS_R) ranges from 4.15% to 18.40%. Average % recovery ranged between 99.8% and 100.3% of the mean target.

10. QUALITY ASURANCE AND MANAGEMENT

10.1 Analyse a standard solution from 1.0 mg/l (3.11.2) at the beginning and end of each series of measurement. The results must be 1.0 ± 0.1 mg/l.

10.2 Before each measurement series analyse a blank sample (3.12) and for the internal quality control (CQI) a overloaded wine (3.13). The blank sample must not be over $0.0 \text{ mg/l} \pm 0.1 \text{ mg/l}$. and the CQI must not be over $1.0 \text{ mg/l} \pm 0.2 \text{ mg/l}$.

Annex A

References

1. AOAC International, AOAC Official Methods Program, Associate Referee's Manual On Development, Study, Review, and Approval Process, 1997
2. Postel, W.; Prash, E., Wein-Wissenschaft, (1975) 30 (6), 320-326
3. Office International de la Vigne et du Vin, Compendium of International Methods of Wine Analysis, 255–257
4. Gil Armentia, J. M.; Arranz, J. F.; Barrio, R. J.; Arranz, A., Anales de Bromatologia, (1988) 40 (1) 71-77
5. Gran, G; Analyst (1952) 77, 661
6. Corning fluoride ion selective electrode – Instruction Manual, 1994
7. Corning Instruction Manual pH/ion analyzer 455, 109121-1 Rev. A, 11/96
8. Horwitz, W.; Albert, R.; Journal of the Association of Official Analytical Chemists, (1991) 74 (5) 718

Annex B

Inter laboratory Study

VALIDATION OF A FLUORIDE ION SELECTIVE ELECTRODE, STANDARD ADDITION METHOD FOR THE MEASUREMENT OF FLUORIDE IN WINE

B.1 Introduction

The validation by collaborative trial of a fluoride selective ion electrode, standard addition method for the determination of fluoride in wine is described. The collaborative trial involved a total of twelve participants, six European and six Americans, who took part in the study. The collaborative study was performed using the AOAC, Youden protocol⁽¹⁾.

B2 Participants

The twelve participants of this validation consisted of laboratories from Austria, France, Germany, Spain, and the United States and comprised of the following: BATF Alcohol and Tobacco Laboratory—Alcohol Section, SF, Walnut Creek, CA., United States; BATF, National Laboratory Ctr., Rockville, MD, United States; Bundesinstitut für Gesundheitlichen Verbraucherschutz, Berlin, Germany; Canandaigua Winery, Madera, CA, United States; CIVC, Epernay, France; E. & J. Gallo Winery-Analytical Services Laboratory, Modesto, CA, United States; E. & J. Gallo Winery-Technical Analytical Services Laboratory, Modesto, CA, United States; ETS Labs, St. Helena, CA, United States; Höhere Bundeslehranstalt & Bundesamt für Wein und Obstbau, Klosterneuburg, Austria; Institut Catala de la Vinya i el Vi, Vilafranca del Penedes (Barcelona), Spain; Laboratorio Arbitral Agroalimentario, Madrid, Spain; and Sutter Home Winery, St. Helena, CA., United States.

B3 Samples used in the trial

The samples used in the trial are given in Appendix I. They were distributed as twelve wine samples (six Youden pairs of samples comprised of three red wines and three white wines).

<u>Sample</u>	<u>Sample description</u>
1	White wine with no fortification (total of 0.6 mg/l F ⁻)
2	White wine fortified with 0.3 mg /l (total of 0.9 mg/l F ⁻)
3	White wine fortified with 0.9 mg /l (total de 1,5 mg/l F ⁻)
4	White wine fortified with 1.2 mg /l (total de 1,8 mg/l F ⁻)
5	White wine fortified with 1.4 mg /l (total de 2,0 mg/l F ⁻)
6	White wine fortified with 1.7 mg /l (total de 2,3 mg/l F ⁻)
7	Red wine with no fortification (total de 0,2 mg/l F ⁻)
8	Red wine fortified with 0.3 mg /l (total de 0,5 mg/l F ⁻)
9	Red wine fortified with 0.8 mg /l (total de 1,0 mg/l F ⁻)
10	Red wine fortified with 1.1 mg /l (total de 1,3 mg/l F ⁻)
11	Red wine fortified with 2.5 mg /l (total de 2,7 mg/l F ⁻)
12	Red wine fortified with 2.8 mg /l (total de 3,0 mg/l F ⁻)

8.4 Results

A summary of the results obtained by the twelve participants is given in Table I. None of the laboratories reported any difficulties with the analysis. One Youden pair from one laboratory was determined to be an outlier, using the Cochran's test. These results are noted^(c) in Table I, and were not used in the statistical analysis.

**COMPENDIUM OF INTERNATIONAL ANALYSIS OF METHODS - OIV
Fluoride**

Table 1

Collaborative data for the determination of fluoride in wine by fluoride selective electrode, standard addition^a

Lab Number	White Wine						Red Wine					
	Pair 1 ^b		Pair 2 ^b		Pair 3 ^b		Pair 4 ^b		Pair 5 ^b		Pair 6 ^b	
	1	2	3	4	5	6	7	8	9	10	11	12
1	0.55	0.80	1.33	1.56	1.86	2.24	0.19	0.45	0.89	1.17	2.54	2.77
2	0.52	0.81	1.39	1.64	1.86	2.31	0.19	0.46	0.92	1.20	2.58	2.77
3	0.52	0.81	1.40	1.70	1.92	2.25	0.14	0.42	0.96	1.22	2.64	2.95
4	0.62	0.98	1.48	1.64	1.85	2.14	0.28	0.56	1.00	1.32	2.64	2.72
5	0.48	0.78	1.34	1.64	1.84	2.11	0.12	0.39	0.88	1.16	2.56	2.82
6	0.53	0.84	1.45	1.74	1.97	2.30	0.13	0.43	0.92	1.21	2.66	2.93
7	0.53	0.76	1.27	1.64	1.89	2.06	0.14	0.40	0.88	1.12	2.44	2.83
8	0.57	0.88	1.51	1.85	2.11	2.33	0.48 ^c	0.48 ^c	1.01	1.32	2.64	3.08
9	0.51	0.81	1.40	1.71	1.90	2.20	0.13	0.42	0.90	1.19	2.60	2.86
10	0.54	0.84	1.43	1.71	1.93	2.22	0.18	0.44	0.96	1.23	2.66	2.87
11	0.60	0.93	1.48	1.75	1.98	2.32	0.25	0.57	1.06	1.31	2.68	2.82
12	0.65	0.94	1.54	1.79	2.05	2.32	0.21	0.52	1.03	1.24	2.81	3.07
N of cases	12	12	12	12	12	12	11	11	12	12	12	12
Minimum	0.48	0.76	1.27	1.56	1.84	2.06	0.12	0.39	0.88	1.12	2.44	2.72
Maximum	0.65	0.98	1.54	1.85	2.11	2.33	0.28	0.57	1.06	1.32	2.81	3.08
Range	0.17	0.22	0.27	0.29	0.27	0.27	0.16	0.18	0.18	0.20	0.37	0.36
Mean	0.55	0.85	1.42	1.70	1.93	2.23	0.18	0.46	0.95	1.22	2.62	2.87
Median	0.54	0.83	1.42	1.71	1.91	2.25	0.18	0.44	0.94	1.22	2.64	2.85
Std Dev	0.050	0.069	0.079	0.079	0.084	0.091	0.052	0.063	0.061	0.065	0.090	0.114

^a Units are mg fluoride/L.

^b Youden pairs

^c Value was deleted from data set by Cochran's Test and was not included in the statistical analysis

**COMPENDIUM OF INTERNATIONAL ANALYSIS OF METHODS - OIV
Fluoride**

Table 2

Statistical data from the collaborative study on the analysis of fluoride in wine by
fluoride selective ion electrode, standard addition method

STATISTIC	White Wine			Red Wine		
	Pair 1	Pair 2	Pair 3	Pair 4	Pair 5	Pair 6
Total # of Labs	12	12	12	11 ^d	12	12
Number of "replicates" per lab	2	2	2	2	2	2
Mean (split levels)	0.55 0.85	1.42 1.70	1.93 2.23	0.18 0.46	0.95 1.22	2.62 2.87
Repeatability variance	0.0006	0.0015	0.0026	0.0002	0.0005	0.0049
Repeatability Standard Deviation	0.0235	0.0382	0.5106	0.0156	0.0211	0.0703
Relative standard deviation RSDr, repeatability	3.35 %	2.45 %	2.45 %	4.88 %	1.94 %	2.55 %
Reproducibility variance	0.0039	0.0070	0.0089	0.0034	0.0042	0.0130
Reproducibility standard deviation	0.0625	0.0835	0.0945	0.0587	0.0647	0.1141
Relative standard deviation RSDR, reproducibility	8.92 %	5.36 %	4.54 %	18.39 %	5.95 %	4.15 %
Horwitz Equation Applied (as RSDR)	16.88	14.97	14.33	19.00	15.80	13.74
HORRAT Value HoR (RSDR (measured)/RSDR (Horwitz))	0.53	0.36	0.32	0.97	0.38	0.30
Average % recovery	93.1	94.6	96.7	91.0	94.4	96.4

^d One lab pair was deleted from data set by Cochran's Test

Method OIV-MA-AS321-04

Type IV method

Total Phosphorus

1. Principle

After nitric oxidation and ashing, and dissolution in hydrochloric acid, phosphoric acid is determined colorimetrically as the yellow phospho-vanadomolybdate complex.

2. Apparatus

- 2.1 Boiling water-bath 100°C
- 2.2 Hot plate
- 2.3 Temperature-controlled electric furnace.
- 2.4 Spectrophotometer measuring absorbance at wavelengths between 300 and 700 nm

3. Reagents

- 3.1 Nitric acid, ($\rho_{20} = 1.39$ g/mL).
- 3.2 Hydrochloric acid, approx. 3 M; hydrochloric acid ($\rho_{20} = 1.15 - 1.18$ g/mL) diluted 1/4 with water.
- 3.3 Vanadomolybdate reagent:
Solution A: dissolve 40 g of ammonium molybdate, $(\text{NH}_4)_6\text{Mo}_7\text{O}_{24}\cdot 4\text{H}_2\text{O}$, in 400 mL water.
Solution B: dissolve 1 g of ammonium vanadate, NH_4VO_3 , in 300 mL water and 200 mL nitric acid ($\rho_{20} = 1.39$ g/L) (3.1). Leave to cool.
Vanadomolybdate reagent: place first solution B then solution A into a 1 liter flask, and make up to the mark with water. Reagent to be used within 8 days of preparation.
- 3.4 P_2O_5 solution, 0.1 g/L.
Prepare a P_2O_5 solution 1 g/L by dissolving 2.454 g of *di*-potassium hydrogen phosphate, K_2HPO_4 , in a liter of water. Dilute 10% (v/v).

4. Procedure

- 4.1 *Ashing*

Place 5 mL* wine or must in a platinum or silica dish and evaporate on a boiling water-bath (2.1). When the residue is nearly dry add 1 mL nitric acid (3.1), place the dish on a hot plate (2.2) for 1 hour then in a furnace (2.3) at 600-650 °C until the ash is white.

4.2 Determination

Add 5 mL of hydrochloric acid, approximately 3 M (3.2) to the ash and transfer the solution to a 100 mL volumetric flask. Rinse the dish with 50 mL distilled water and pour the washings into the flask. Add exactly 25 mL of vanadomolybdate reagent, stir and leave for 15 to 20 min to allow the color to develop. Determine the absorbance at 400 nm.

Simultaneously, prepare standard solutions. Place in five 100 mL volumetric flasks, 5, 10, 15, 20 and 25 mL respectively of P₂O₅ solution, 0.1 g/L (3.4). Make up to 50 mL with distilled water and add 25 mL vanadomolybdate reagent. Leave for the exact same time as the samples, to allow the color to develop. Make up to the mark with water and measure the absorbance at 400 nm.

In order to remain in the best absorbance zone do not reset to zero with distilled water, but set the deviation of the spectrophotometer galvanometer on a given absorbance for a determined concentration.

5. Expression of results

5.1 Calculation

The total phosphorous content expressed in milligrams per liter of phosphoric anhydride, P₂O₅, is obtained by entering the absorbance of the wine sample on the calibration graph and interpolating the total phosphorus concentration.

The total phosphorous content is expressed in milligrams per liter P₂O₅ to the nearest whole number.

BIBLIOGRAPHY

A.F.N.O.R., Norme U, 42-246, Tour Europe, Paris.
SUDRAUD P., *Bull. O.I.V.*, 1969, 462-463, 933.

* A 5 mL sample volume is suitable for P₂O₅ content, of between 100 and 500 mg/L. Outside these concentration limits, increase or decrease the sample volume.

Sulfates

1. Principle

Gravimetric determination following precipitation of barium sulfate. The barium phosphate precipitated at the same time is eliminated by washing the precipitate in hydrochloric acid.

In the case of musts or wine rich in sulfur dioxide, prior de-sulfiting by boiling in an airtight vessel is recommended.

2. Method

2.1 Reagents

2.1.1 Hydrochloric acid, 2 M.

2.1.2 Barium chloride solution, $\text{BaCl}_2 \cdot 2\text{H}_2\text{O}$, 200 g/L.

2.2 Procedure

2.2.1 General procedure:

Introduce 40 mL of the sample to be analyzed into a 50 mL centrifuge tube; add 2 mL hydrochloric acid, 2 M (2.1.1), and 2 mL of barium chloride solution, 200 g/L (2.1.2). Stir with a glass stirrer; rinse the stirrer with a little distilled water and leave to stand for five min. Centrifuge for five min, then carefully decant the supernatant liquid.

Wash the barium sulfate precipitate as follows: add 10 mL hydrochloric acid, 2 M (2.1.1), place the precipitate in suspension and centrifuge for five min, then carefully decant the supernatant liquid. Repeat the washing procedure twice as before using 15 mL distilled water each time.

Quantitatively transfer the precipitate, with distilled water, into a tared platinum capsule and place over a water bath at 100°C until fully evaporated. The dried precipitate is calcined several times briefly over a flame until a white residue is obtained. Leave to cool in a desiccator and weigh.

Let m = mass in milligrams of barium sulfate obtained.

2.2.2 Special procedure: sulfited must and wine with a high sulfur dioxide content.

Elimination of sulfur dioxide.

Measure 25 mL of water and 1 mL of concentrated hydrochloric acid ($\rho_{20} = 1.15$ to 1.18 g/mL) into a 500 mL conical flask equipped with a dropping funnel and an outlet tube. Boil the solution to remove the air and introduce

100 mL of wine through the dropping funnel. Continue boiling until the volume of liquid in the flask has been reduced to about 75 mL and quantitatively transfer, after cooling, to a 100 mL volumetric flask. Make up to mark with water. Determine the sulfate in the 40 mL sample as indicated in 2.2.1.

2.3. Expression of results

2.3.1 Calculations:

The sulfate content, expressed in milligrams per liter of potassium sulfate, K_2SO_4 is given by:

$$18.67 \times m$$

The sulfate content in musts or wine is expressed in milligrams per liter of potassium sulfate, to the nearest whole number.

2.3.2 Repeatability (*r*):

up to 1000 mg/L:	$r = 27$ mg/L
approx. 1500 mg/L:	$r = 41$ mg/L

2.3.3 Reproducibility (*R*):

up to 1000 mg/L:	$R = 51$ mg/L
approx. 1500 mg/L:	$R = 81$ mg/L

BIBLIOGRAPHY

- DEIBNER L , BÉNARD P., *Ind. alim. agric.*, 1954, **71**, n^o1, 23; n^o5, 427; 1955, **72**, n^o9-10, 565 et n^o11, 673.
- DEIBNER L., *Rév. ferm. ind. alim.*, 1959, **14** n^o5, 179 et n^o6, 227.
- BLAREZ Ch., *Vins et spiritueux*, 1908, 149, Maloine éd., Paris.
- DER HEIDE X. von, SCHITTHENNER F., *Der Wein*, 1922, 320, Vieweg & Sohn Verlag, Braunschweig.
- JAULMES P., *Analyse des vins*, 1924, 73, Dubois et Poulain, éd., Montpellier; 2^e édition, 1951, 112.
- SIMONEAU G., *Étude sur les moûts concentrés de raisins*, 1946, Thèse pharm., Montpellier, 49.
- RIBÉREAU-GAYON J., PEYNAUD E., *Analyse et contrôle des vins*, 1947, 244, Ch. Béranger éd., Paris-Liège.
- FROLOV-BAGREEV A., AGABALIANZ G., *Chimie du vin*, 1951, 369, Moscou, Laboratoire de chimie de l'État de Würzburg (Allemagne), *F.V., O.I.V.*, 1969, no321.

Method OIV-MA-AS321-05B

Sulfates

Quick test method

Wines are classified into several categories using the so-called “limits” method, based on the precipitation of barium sulfate using a barium ion titrant.

WITHDRAWN

Method OIV-MA-AS322-01

Type IV method

Ammonium

1. Principle

Retention of the ammonium cation on a weak cation exchange resin, elution using an acidic solution, distillation of the eluent and determination of the ammonia in the distillate by titration with a standardized solution of hydrochloric acid.

2. Apparatus

2.1 Cation exchange resin column

A 50 mL burette with a glass stopcock fitted with a glass wool plug containing 25 g of weak cation exchange resin (e.g. Amberlite IR-50, 80-100 mesh).

Wash alternately with 1 M sodium hydroxide solution and 1 M hydrochloric acid solution. Wash the resin with distilled water until a negative reaction of chloride ion with silver nitrate is obtained. Pass 50 mL of neutral buffer slowly through the glass column, rinse with distilled water until phosphates begin to elute as detected using a saturated solution of lead acetate.

2.2 Distillation apparatus

Use the apparatus described in the chapter on *Alcoholic Strength 3.1*

The condensate is transferred to the conical flask through a drawn-out tube touching the bottom of the vessel.

Alternatively, it is possible to use the steam distillation apparatus used in the chapter on *Volatile Acidity 4.1* or other apparatus that can be used for the following experiments which check the purity of the reagents.

- a) Place 40-45 mL of 30 % sodium hydroxide solution (v/v), 50 mL of water and 50 mL hydrochloric acid, 1 M, in the distillation flask. Distil half the volume and collect the distillate in 30 mL of boric acid solution, 40 g/L to which 5 drops of methyl red have been added. Adjust the color to pink by the addition of 0.1 mL of 0.1 M hydrochloric acid.
- b) A test (similar to that described in a) is conducted using, 10 mL 0.05 M ammonium sulfate solution, containing 3.55 g/L of anhydrous ammonium sulfate, $(\text{NH}_4)_2\text{SO}_4$. In this case, between 10 and 10.1 mL 0.1 M hydrochloric acid must be used to obtain the change of color of the indicator.

3. Reagents

3.1 Hydrochloric acid solution, 1 M.

3.2 Sodium hydroxide, 1 M.

3.3 Neutral solution to wash the resin:

<i>di</i> -sodium hydrogen phosphate Na ₂ PO ₄ ·12H ₂ O	15 g
potassium <i>di</i> -hydrogen phosphate KH ₂ KO ₄	3.35 g
water to	1000 mL

Verify pH is 7±0.2

3.4 Sodium hydroxide solution, 30% (*m/m*), ρ = 1.33 g/mL

3.5 Hydrochloric acid solution, 0.1 M.

3.6 Phenolphthalein solution, 1% (*m/v*), in neutral ethanol, 96% (*V/V*)

3.7 Bromocresol green solution, 1% (*m/v*):

bromocresol green	1 g
dissolve in 0.1 M sodium hydroxide solution,	14 mL
water to.....	100 mL

3.8 Methyl red ethanol/water solution, 0.2% (*v/v*):

methyl red	0.2 g
alcohol, 95% (<i>vol.</i>)	60 mL
water to	100 mL

3.9 Boric acid solution

Boric acid	40g
Water to	1000mL

Boric acid usually contains a small quantity of alkaline impurities and it is possible to correct this by adding 5 drops of indicator to this solution and adjusting to a pink color by means of few drops of 0.1 M hydrochloric acid (1 mL at most).

4. Procedure

Transfer 50 mL of the sample to be analyzed into a 250 mL beaker. Add a quantity of sodium hydroxide, 1 M, equal to half of (*n*-0.5) mL, where *n* is the volume sodium hydroxide solution, 0.1 M, used in the total acidity titration on 10 mL of wine. Pass this mixture through the cation exchange column (2.1) at a rate of one drop every two seconds. The eluent pH should lie between 4 and 5. Rinse the column with 50 mL of distilled water at the same flow rate.

Ammonium and other cations are quantitatively retained on the column. Amides, oligopeptides and nearly all amino acids are eluted by the washing procedure.

Elute the cations retained on the resin with 50 mL of 1 M hydrochloric acid, (3.1) and rinse with 50 mL distilled water.* The eluate and the water washings are combined in a 1 liter round bottom distillation flask.

Add one drop of phenolphthalein, 1% (*m/v*), and sufficient quantity of 30% sodium hydroxide solution (*m/v*)(3.4), to obtain a true alkaline reaction, constantly cooling the flask during this addition.

Distil about half the volume of the liquid from the distillation flask, into 30 mL of 4% boric acid (*m/v*)(3.9).

The distillate is titrated with 0.1 M hydrochloric acid (3.5), in the presence of bromocresol green or methyl red. Record the volume of hydrochloric acid used (*n*).

5. Expression of results

The content of ammonium (NH₄) ions is expressed in milligrams per liter to the nearest whole number.

5.1 Calculation

The content of ammonium ions, expressed in milligrams per liter is:

$$36 \times n$$

When wines with low ammonium content are analyzed, the determination is conducted using 100 mL of wine. In this case the quantity of ammonium is given by:

$$18 \times n$$

BIBLIOGRAPHY

Usual Method:

JAULMES P., *Analyse des vins*, 1951, 220, Montpellier

KOURAKOU Mme S., *Ann. Fals. Exp. Chim.*, 1960, **53**, 337.

* The column should be washed with 50 mL of neutral buffer solution and rinsed with water before using the column for another determination.

Method OIV-MA-AS322-02A

Type II method

Potassium

1. Principle

Potassium is determined directly in diluted wine by atomic absorption spectrophotometry after the addition of cesium chloride to suppress ionization of potassium.

2 Method

2.1 Apparatus

- Atomic absorption spectrophotometer, equipped with an air-acetylene burner
- Potassium hollow cathode lamp

2.2 Reagents

2.2.1 Solution containing 1 g of potassium per liter.

Use a standard commercial solution containing 1 g of potassium per liter. This solution may be prepared by dissolving 4.813 g of potassium hydrogen tartrate ($C_4H_5KO_6$) in distilled water and making up the volume to 1 liter with water.

2.2.2 Matrix (model) solution:

citric acid monohydrate	3.5 g
sucrose	1.5 g
glycerol	5.0 g
anhydrous calcium chloride, ($CaCl_2$)	50 mg
anhydrous magnesium chloride ($MgCl_2$)	50 mg
absolute alcohol	50 mL
water to	500 mL

2.2.3 Cesium chloride solution containing 5% cesium:

Dissolve 6.33 g of cesium chloride, $CsCl$, in 100 mL of distilled water.

2.3 Procedure

2.3.1 Preparation of sample

Pipette 2.5 mL of wine (previously diluted 1/10) into a 50 mL volumetric flask, add 1 mL of the cesium chloride solution and make up to the mark with distilled water.

2.3.2 Calibration

Introduce 5.0 mL of the matrix solution into each one of five of 100mL volumetric flasks and add 0, 2.0, 4.0, 6.0 and 8.0 mL respectively of the 1 g/L potassium solution (previously diluted 1/10). Add 2 mL of the cesium chloride solution to each flask and make up to 100 mL with distilled water.

The standard solutions contain 0, 2, 4, 6 and 8 mg of potassium per liter respectively and each contains 1 g of cesium per liter. Keep these solutions in polyethylene bottles.

2.3.3 Determination

Set the wavelength to 769.9 nm. Zero the absorbance scale using the zero standard solution (2.3.2). Aspirate the diluted wine (2.3.1) directly into the spectrophotometer, followed in succession by the standard solutions (2.3.2). Record the absorbance for each solution and repeat.

2.4 *Expression of results*

2.4.1 Method of calculation

Plot a graph showing the variation in absorbance as a function of potassium concentration in the standard solutions.

Record the mean absorbance obtained with diluted wine on this graph and determine its potassium concentration C in milligrams per liter.

The potassium concentration, expressed in milligrams per liter of the wine to the nearest whole number, is $F \times C$, where F is the dilution factor (here 200).

2.4.2 Repeatability (*r*): $r = 35 \text{ mg/L}$.

2.4.3 Reproducibility (R): $R = 66 \text{ mg/L}$.

2.4.4 Other ways of expressing results

- In milliequivalents per liter: $0.0256 \times F \times C$.
- In mg potassium hydrogen tartrate per liter: $4.813 \times F \times C$.

Potassium

1. Principle

Potassium is determined directly in diluted wine by flame photometry.

Note: The gravimetric determination of potassium tetraphenylborate precipitated from the solution of the ash of wine is a precise method for the determination of potassium and is described in the annex.

2. Method

2.1 Apparatus

2.1.1 Flame photometer supplied with an air-butane mixture.

2.2 Reagents

2.2.1 Reference solution containing 100 mg potassium per liter

Absolute alcohol	10 mL
Citric acid C ₆ H ₈ O ₇ , H ₂ O	700 mg
Sucrose	300 mg
Glycerol	1000 mg
Sodium chloride, NaCl	50.8 mg
Anhydrous calcium chloride, CaCl ₂	10 mg
Anhydrous potassium hydrogen tartrate	481.3 mg
water to	1000 mL

Dissolve the potassium hydrogen tartrate in 500 mL of very hot distilled water, mix this solution with 400 mL of distilled water in which the other chemicals have already been dissolved, and make up to one liter.

2.2.2 Dilution solution

Absolute alcohol	10 mL
Citric acid anhydrous	700 mg
Sucrose	300 mg
Glycerol	1000 mg
Sodium chloride, NaCl	50.8 mg
Anhydrous calcium chloride, CaCl ₂	10 mg
Anhydrous magnesium chloride, MgCl ₂	10 mg
Tartaric acid	383 mg
Water to	1000 mL

Preserve the solutions in polyethylene bottles by adding two drops of allyl isothiocyanate (3-isothiocyanato-1-propene; CH₂=CHCH₂NCS).

2.3 Procedure

2.3.1 Calibration

Place 25, 50, 75 and 100 mL of the reference solution into a set of four 100 mL volumetric flasks and make up to 100 mL with the dilution solution to give solutions containing 25, 50, 75 and 100 mg of potassium per liter respectively.

2.3.2 Determination

Make measurements at 766 nm. and adjust the 100% transmission using distilled water. Successively aspirate the standard solutions directly into the burner of the photometer, followed by wine diluted 1/10 with distilled water and note the readings. If necessary, the wine already diluted $\frac{1}{10}$ may be further diluted with the dilution solution (2.2.2).

2.4 Expression of results

2.4.1 Method of calculation

Plot a graph of the variation in percentage transmission as a function of the potassium concentration in the standard solutions. Record the transmission obtained for the sample of diluted wine on this graph and determine the corresponding potassium concentration C.

The potassium concentration in mg potassium per liter to the nearest whole number will be:

$$F \times C$$

where F is the dilution factor.

2.4.2 Repeatability (*r*): $r = 17$ mg/L.

2.4.3 Reproducibility (R): $R = 66$ mg/L.

2.4.4 Other ways of expressing results:

- In milliequivalents per liter: $0.0256 \times F \times C$.
- In mg potassium hydrogen tartrate per liter $4.813 \times F \times C$.

Method OIV-MA-AS322-02C

Potassium
(Resolution Oeno 377/2009)

Gravimetric determination of potassium using sodium tetraphenylborate

WITHDRAWN

Method OIV-MA-AS322-03A

Type II method

Sodium

1. Principle

Sodium is determined directly in the wine by atomic absorption spectrophotometry after the addition of cesium chloride to suppress ionization of sodium.

2. Method

2.1 Apparatus

- Atomic absorption spectrophotometer equipped with an air-acetylene burner.
- Sodium hollow cathode lamp.

2.2 Reagents

2.2.1 Solution containing 1 g of sodium per liter:

The use of a commercial standard solution containing 1 g of sodium per liter is preferred.

Alternatively, this solution may be prepared by dissolving 2.542 g of anhydrous sodium chloride (NaCl) in distilled water and making up to a volume of 1 liter.

Keep this solution in a polyethylene bottle.

2.2.2 Matrix (model) solution:

Citric acid monohydrate, (C ₆ H ₈ O ₇ .H ₂ O)	3.5 g
Sucrose	1.5 g
Glycerol	5.0 g
Anhydrous calcium chloride (CaCl ₂)	50 mg
Anhydrous magnesium chloride, (MgCl ₂)	50 mg
Absolute alcohol	50 mL
De-ionized water to	500 mL

2.2.3 Cesium chloride solution containing 5% cesium

Dissolve 6.330 g of cesium chloride, CsCl, in 100 mL of distilled water.

2.3 Procedure

2.3.1 Preparation of the sample

Pipette 2.5 mL of wine into a 50 mL volumetric flask, add 1 mL of the cesium chloride solution (2.2.3) and make up to the mark with distilled water.

2.3.2 Calibration

Place 5.0 mL of the matrix solution in each one of five 100 mL volumetric flasks and add 0, 2.5, 5.0, 7.5 and 10 mL respectively of a 1:100 dilution of the 1 g/L sodium solution. Add 2 mL of the cesium chloride solution (2.2.3) to each flask and make up to 100 mL with distilled water.

The standard solutions prepared in this way contain 0.25, 0.50, 0.75 and 1.00 mg of sodium per liter respectively and each contains 1 g of cesium per liter. Keep these solutions in polyethylene bottles.

2.3.3 Determination

Set the absorbance wavelength to 589.0 nm. Zero the absorbance scale using the zero standard solution. Aspirate the diluted wine (2.3.1) directly into the spectrophotometer, followed in succession by the standard solutions (2.3.2). Record each absorbance and repeat each measurement.

2.4 *Expression of results*

2.4.1 Method of calculation

Plot a graph of measured absorbance versus the sodium concentration in the standard solutions.

Record the absorbance obtained with the diluted wine on this graph and determine its sodium concentration C in milligrams per liter.

The sodium concentration in milligrams per liter of the wine will then be F x C, expressed to the nearest whole number, where F is the dilution factor.

2.4.2. Repeatability (*r*): $r = 1 + 0.024 x_i$ mg/L.
 x_i = concentration of sodium in the sample in mg/L.

2.4.3. Reproducibility (R): $R = 2.5 + 0.05 x_i$ mg/L.
 x_i = concentration of sodium in the sample in mg/L.

Sodium

1. Principle

Sodium is determined directly in diluted wine (at least 1 mL:10 mL) by flame photometry.

2. Method

2.1 Apparatus

2.1.1. Flame photometer supplied with an air-butane mixture.

2.2 Reagents

2.2.1 Reference solution containing 20 mg sodium per liter

Absolute alcohol	10 mL
Citric acid monohydrate (C ₆ H ₈ O ₇ · H ₂ O)	700 mg
Sucrose	300 mg
Glycerol	1000 mg
Potassium hydrogen tartrate	481.3 mg
Anhydrous calcium chloride, CaCl ₂	10 mg
Anhydrous magnesium chloride, MgCl ₂	10 mg
Dry sodium chloride, NaCl	50.84 mg
Water to	1000 mL

2.2.2 Dilution solution

Absolute alcohol	10 mL
Citric acid monohydrate (C ₆ H ₈ O ₇ · H ₂ O)	700 mg
Sucrose	300 mg
Glycerol	1000 mg
Potassium hydrogen tartrate	481.3 mg
Anhydrous calcium chloride, CaCl ₂	10 mg
Anhydrous magnesium chloride, MgCl ₂	10 mg
Water to	1000 mL

To prepare 2.2.1 and 2.2.2, dissolve the potassium hydrogen tartrate in approximately 500 mL of very hot distilled water, mix with 400 mL of distilled water into which the other chemicals have already been dissolved, and make up to one liter.

Preserve the solutions in polyethylene bottles by adding two drops of allyl isothiocyanate to each.

2.3 Procedure

2.3.1 Calibration

Place 5, 10, 15, 20 and 25 mL of the reference solution in each of five 100 mL volumetric flasks and make up to 100 mL with the dilution solution to give solutions containing 1, 2, 3, 4 and 5 mg of sodium per liter respectively.

2.3.2 Determination

Carry out measurements at 589.0 nm and adjust the 100% transmission using distilled water. Successively aspirate the standard solutions directly into the photometer, followed by the wine diluted 1:10 with distilled water and note the percentage transmission of each. If necessary, the wine already diluted 1:10 may be further diluted with dilution solution.

2.4 Expression of results

2.4.1 Calculation method

Plot a graph of the percentage transmittance versus sodium concentration of the standard solutions. Record the transmission obtained for the diluted wine sample on this graph and note the concentration, C , of sodium in the wine.

The sodium concentration in mg of sodium per liter will be:

$$F \times C$$

where F is the dilution factor.

2.4.2 Repeatability (r)

$$r = 1.4 \text{ mg/L (except for liqueur wine)}$$

$$r = 2.0 \text{ mg/L for liqueur wine.}$$

2.4.3. Reproducibility (R)

$$R = 4.7 + 0.08 x_j \text{ mg/L.}$$

x_j = sodium concentration in the sample in mg/L.

Method OIV-MA-AS322-04

Type II method

Calcium

1. Principle

Calcium is determined directly on diluted wine by atomic absorption spectrophotometry after the addition of an ionization suppression agent.

2. Apparatus

- 2.1 Atomic absorption spectrophotometer fitted with an air-acetylene burner.
- 2.2 Calcium hollow cathode lamp.

3. Reagents

- 3.1 Calcium standard solution 1 g/L. Use of a standard commercial calcium solution, 1 g/L, is preferred.

Alternatively this solution may be prepared by dissolving 2.5 g of calcium carbonate, CaCO_3 , in sufficient hydrochloric acid (concentrated hydrochloric acid diluted 1:10) to dissolve it completely and making up to one liter with distilled water.

- 3.2 Dilute calcium standard solution, 50 mg/L

Note : Store the calcium solutions in polyethylene containers.

- 3.3 Dilute lanthanum standard solution, 50 g/L

Dissolve 13.369 g of lanthanum chloride, $\text{LaCl}_3 \cdot 7\text{H}_2\text{O}$ in distilled water; add 1 mL, of dilute hydrochloric acid (concentrated hydrochloric acid diluted 1/10) and make up to 100 mL with distilled water.

4. Procedure

4.1 Preparation of sample

Place 1 mL of wine and 2 mL of the lanthanum chloride solution (3.3) in a 20 mL volumetric flask and make up to the mark with distilled water. The diluted wine contains 5 g lanthanum per liter.

Note: For sweet wines, 5 g lanthanum per liter is sufficient provided that the dilution reduces the sugar content to less than 2.5 g/L. For wines with higher concentrations of sugar, the lanthanum concentration should be increased to 10 g/L.

4.2 Calibration

Place 0, 5, 10, 15 and 20 mL, of dilute standard calcium solution (3.2) respectively into each of five 100 mL volumetric flasks, followed by 10 mL of

the lanthanum chloride solution (3.3) and make up to 100 mL with distilled water. The solutions prepared in this way contain 0, 2.5, 5.0, 7.5 and 10 mg of calcium per liter respectively, and each contains 5 g of lanthanum per liter. These solutions should be stored in polyethylene bottles.

4.3 *Determination*

Set the absorbance wavelength to 422.7 nm. Zero the absorbance scale using the zero standard (4.2). Aspirate the diluted wine directly into the spectrophotometer, followed in succession by the five standard solutions (4.2) and record the absorbance. Repeat each measurement.

5. Expression of results

5.1 *Method of calculation*

Plot a graph showing the variation in absorbance as a function of the calcium concentration in the standard solutions.

Record the mean value of the absorbance obtained with the sample of diluted wine on this graph and read its calcium concentration *C*. The calcium concentration in milligrams per liter of the wine to the nearest whole number is given by:

$$20 \times C.$$

5.2 *Repeatability (r)*

Concentration < 60 mg/L: $r = 2.7 \text{ mg/L}$.

Concentration > 60 mg/L: $r = 4 \text{ mg/L}$.

5.3 *Reproducibility (R)*

$$R \text{ mg/L} = 0.114 x_i - 0.5.$$

where x_i = concentration in the sample in mg/L.

Iron

1. Principle

After suitable dilution of the wine and removal of alcohol, iron is determined directly by atomic absorption spectrophotometry.

2. Method

2.1 Apparatus

- 2.1.1 Rotary evaporator with thermostatically controlled water bath.
- 2.1.2 Atomic absorption spectrophotometer equipped with an air-acetylene burner.
- 2.1.3 Iron hollow cathode lamp.

2.2 Reagents

- 2.2.1 Concentrated standard iron solution containing 1 g Fe (III) per liter.

Use a standard commercial solution, 1 g/L. This solution may be prepared by dissolving 8.6341 g of ferric ammonium sulfate, $\text{FeNH}_4(\text{SO}_4)_2 \cdot 12\text{H}_2\text{O}$, in distilled water slightly acidified with hydrochloric acid, 1 M, and making up to one liter.

- 2.2.2 Dilute standard iron solution containing 100 mg iron per liter.

2.3 Procedure

2.3.1 *Preparation of sample*

Remove the alcohol from the wine by reducing the volume of the sample to half its original size using a rotary evaporator (50 to 60 °C). Make up to the original volume with distilled water.

If necessary, dilute prior to analysis with distilled water.

2.3.2 *Calibration*

Place 1, 2, 3, 4 and 5 mL of the solution containing 100 mg iron per liter (2.2.2) respectively into each of five 100 mL volumetric flasks and make up to 100 mL with distilled water. The solutions prepared in this way contain 1, 2, 3, 4 and 5 mg of iron per liter respectively. These solutions should be stored in polyethylene bottles.

2.3.3 *Determination*

Set the absorption wavelength to 248.3 nm. Zero the absorbance scale using distilled water. Aspirate the diluted sample directly into the spectrophotometer,

followed in succession by the five standards (2.3.2). Record the absorbance. Repeat each measurement.

2.4 Expression of results

2.4.1 Method of calculation

Plot a graph giving the variation in absorbance as a function of the iron concentration in the standard solutions. Record the mean value of the absorbance obtained with the diluted wine sample on this graph and read its iron concentration C.

The iron concentration in milligrams per liter of the wine to one decimal place is given by:

$$F \times C$$

where F is the dilution factor.

Iron

1. Principle

After digestion in hydrogen peroxide, 30%, the total iron, present as Fe (III) state, is reduced to the Fe (II) and quantified by the formation of a colored *ortho*-phenanthroline complex.

2. Method

2.1 Apparatus

2.1.1 Kjeldahl flask, 100 mL.

2.1.2 Spectrophotometer enabling measurements to be made at a wavelength of 508 nm.

2.2 Reagents

2.2.1 Hydrogen peroxide, H₂O₂, 30% (*m/v*), solution, iron free.

2.2.2 Hydrochloric acid, 1 M, iron free.

2.2.3 Ammonium hydroxide ($\rho_{20} = 0.92$ g/mL).

2.2.4 Pumice stone grains, pretreated with boiling hydrochloric acid_diluted 1/2 and washed with distilled water.

2.2.5 Hydroquinone solution, C₆H₆O₂, 2.5%, acidified with 1 mL concentrated sulfuric acid ($\rho_{20} = 1.84$ g/mL) per 100 mL of solution. This solution must be kept in an amber bottle in the refrigerator and discarded at the slightest sign of darkening.

2.2.6 Sodium sulfite solution, Na₂S₀₃, 20%, prepared from neutral anhydrous sodium sulfite.

2.2.7 *ortho*-phenanthroline solution, C₁₂H₈N₂, 0.5%, in alcohol, 96% vol.

2.2.8 Ammonium acetate solution, CH₃COONH₄, 20% (*m/v*).

2.2.9 Fe (III) solution containing 1 g of iron per liter. Use of a commercial solution is preferred. Alternatively, a 1000 mg/L Fe (III) solution can be prepared by dissolving 8.6341 g of ferric ammonium sulfate, FeNH₄(SO₄)₂.12H₂O, in 100 mL of hydrochloric acid, 1 M, and making up the volume to one liter with the hydrochloric acid, 1 M.

2.2.10 Dilute standard iron solution containing 100 milligrams of iron per liter.

2.3 Procedure

2.3.1 Digestion

2.3.1.1 For wines with sugar content below 50 g/L

Combine 25 mL of the wine, 10 mL of the hydrogen peroxide solution and a few grains of pumice into the 100 mL Kjeldahl flask. Concentrate the mixture to a volume of 2 to 3 mL by heating. Allow to cool and add sufficient ammonium hydroxide to make the residue alkaline thus precipitating hydroxides while taking care not to wet the walls of the flask.

After cooling, carefully add hydrochloric acid, to the alkaline liquid to dissolve the precipitated hydroxides and transfer the resulting solution to a 100 mL volumetric flask. Rinse the Kjeldahl flask with hydrochloric acid, and combined the solutions in the volumetric flask and make up to 100 mL.

2.3.1.2 For musts and wines with sugar content above 50 g/L

- If the sugar content is between 50 and 200 g/L, the 25 mL wine sample is treated with 20 mL of hydrogen peroxide solution. Continue as in 2.3.1.1.
- If the sugar content is greater than 200 g/L, the samples of wine or must should be diluted 1/2 or possibly 1/4 before being treated with 20 mL of hydrogen peroxide solution. Continue as in 2.3.1.1.

2.3.2 Blank experiment

Carry out a blank trial with distilled water using the same volume of hydrogen peroxide solution as the amount used for the mineralization, following the experimental protocol described in 2.3.1.1.

2.3.3 Determination

Introduce 20 mL of the hydrochloric acid wine digest solution and 20 mL, of the hydrochloric acid solution obtained from the 'blank experiment' into two separate 50 mL volumetric flasks. Add 2 mL of hydroquinone solution, 2 mL of sulfite solution and 1 mL of *ortho*-phenanthroline. Allow to stand for 15 minutes, during which time Fe (III) is reduced to Fe (II). Then add 10 mL of ammonium acetate solution, make each up to 50 mL with distilled water and shake the two volumetric flasks. Use the solution originating from the blank experiment to zero the absorbance scale at 508 nm and measure the absorbance of the wine solution at the same wavelength.

2.3.4 Calibration

Place 0.5, 1, 1.5 and 2 mL of the 100 mg of iron per liter solution into each of four 50 mL volumetric flasks, and add 20 mL of distilled water to each. Carry out the procedure described in 2.3.3 to measure the absorbance of each of these

standard solutions, which contain 50, 100, 150 and 200 micrograms of iron respectively.

2.4 *Expression of results*

2.4.1 Method of calculation

Plot a graph giving the variation in absorbance as a function of the iron concentration in the standard solutions. Record the absorbance of the test solution and read off the iron concentration *C* in the hydrochloric acid digestion solution, i.e. in 5 mL of the wine being analyzed.

The iron concentration in milligrams per liter of the wine to one decimal place is given by:

$$200 \times C$$

If the wine (or must) has been diluted, the iron concentration in milligrams per liter of the wine to one decimal place is given by:

$$200 \times F \times C$$

where *F* is the dilution factor.

Method OIV-MA-AS322-06

Type IV method

Copper
(Resolution Oeno 377/2009)

1. Principle

The method is based on the use of atomic absorption spectrophotometry.

2. Apparatus

- 2.1 Platinum dish.
- 2.2 Atomic absorption spectrophotometer.
- 2.3 Copper hollow cathode lamp.
- 2.4 Gas supplies: air-acetylene or nitrous oxide/acetylene.

3. Reagents

- 3.1 Metallic copper.
- 3.2 Nitric acid ($\rho_{20} = 1.38$ g/mL), 65%.
- 3.3 Nitric acid (3.2), diluted 1/2 (v/v) with water.
- 3.4 Solution containing 1g of copper per L.

Use of a standard commercial copper solution is preferred. Alternatively this solution may be prepared by weighing 1.000 g of metallic copper and transferring it without loss to a 1000 mL volumetric flask. Add just enough dilute nitric acid to dissolve the metal, add 10 mL of concentrated nitric acid and make up to the mark with double distilled water.

- 3.5 Solution containing copper at 100 mg/L
Transfer 10 mL, of the 1 g/L solution 3.4. into a 100 mL volumetric flask, and make up to the mark with double-distilled water.
- 3.6 Double-distilled water

4. Procedure

4.1 *Preparation of sample and determination of copper*

Place 20 mL sample in a 100 mL volumetric flask and make up to 100 mL with double-distilled water. Modify the dilution if necessary to obtain a response within the dynamic range of the detector.

Measure the absorbance at 324.8 nm. Set the zero with double distilled water.

4.2 *Constructing a standard curve*

Pipette 0.5, 1 and 2 mL of copper solution into each of three 100 mL volumetric flasks and make to the volume with double distilled water; the solutions contain 0.5, 1 and 2 mg of copper per liter respectively. Measure the absorbance of standard solutions and the sample prepared in and repeat each measurement. Plot a graph showing the variation in absorbance as a function of the copper concentration in the standard solutions.

5 Expression of results

5.1 *Method of calculation*

Using the measured absorbance of the samples read off the concentration C in mg/L from the calibration curve.

If F is the dilution factor, the concentration of the copper present is given in milligrams per liter by:

$$F \times C.$$

It is quoted to two decimal places.

Notes:

- a) Select a sample dilution appropriate to the sensitivity of the apparatus to be used and the concentration of the copper present in the sample.
- b) Proceed as follows when very low copper concentrations are expected in the sample to be analyzed: Place 100 mL of the sample in a platinum dish and evaporate on a water bath at 100 °C until it becomes syrupy. Add 2.5 mL of concentrated nitric acid drop wise, covering the bottom of the dish completely. Carefully ash the residue on an electric hotplate or over a low flame; then place the dish in a muffle furnace set at $500^{\circ} \pm 25^{\circ}\text{C}$ and leave for about one hour. After cooling, moisten the ash with 1 mL of concentrated nitric acid while crushing it with a glass rod; allow the mixture to evaporate and ash again as before. Place the dish in the muffle furnace again for 15 min; repeat the treatment with nitric acid at least three times. Dissolve the ash by adding 1 mL of concentrated nitric acid and 2 mL of double distilled water to the dish and transfer to a 10 mL flask. Wash the dish three times using 2 mL of double distilled water each time. Finally, make to volume with double distilled water. Proceed to analyze the sample as in 4.1 but use 10 mL of solution. Take into account the change in dilution factor when calculating the results.

Method OIV-MA-AS322-07

Type II method

Magnesium

1. Principle

Magnesium is determined directly on diluted wine by atomic absorption spectrophotometry.

2. Apparatus

2.1 Atomic absorption spectrophotometer fitted with an air-acetylene burner.

2.2 Magnesium hollow cathode lamp.

3. Reagents

3.1 Concentrated magnesium standard solution containing 1 g/L

Use of a standard commercial magnesium solution (1 g/L) is preferred.

Alternatively, this solution may be prepared by dissolving 8.3646 g of magnesium chloride, $\text{MgCl}_2 \cdot 6\text{H}_2\text{O}$, in distilled water and making up to 1 liter.

3.2 Dilute magnesium standard solution, 5 mg/L.

Note: Keep the standard magnesium solutions in polyethylene bottles.

4. Procedure

4.1 *Preparation of sample*

The wine is diluted 1/100 with distilled water.

4.2 *Calibration*

Place 5, 10, 15 and 20 mL of the dilute standard magnesium solution into each one of a set of four 100 ml. volumetric flasks and make up to 100 mL with distilled water. The standard solutions prepared in this way contain 0.25, 0.50, 0.75 and 1.0 mg of magnesium per liter respectively. These solutions should be kept in polyethylene bottles.

4.3 *Determination*

Set the absorption wavelength to 285 nm. Zero the absorbance scale using distilled water. Aspirate the diluted wine directly into the spectrophotometer, followed in succession by the standard solutions (4.2).

Record the absorbance of each solution and repeat each measurement.

5. Expression of results

5.1 Method of calculation

Plot a graph showing the variation in absorbance as a function of the magnesium concentration in the standard solutions.

Record the mean value of absorbance with the diluted sample of wine on this graph and read off the magnesium concentration C in milligrams per liter. The magnesium concentration in milligrams per liter of the wine to the nearest whole number is given by:

$$100 \times C$$

5.2 *Repeatability (r)*: $r = 3 \text{ mg/L}$.

5.3 *Reproducibility (R)*: $R = 8 \text{ mg/L}$.

Method OIV-MA-AS322-08

Type IV method

Zinc

1. Principle

After removal of alcohol, zinc is determined directly in the wine by atomic absorption spectrophotometry.

2. Apparatus

- 2.1 Rotary evaporator and thermostatically controlled water bath.
- 2.2 Atomic absorption spectrophotometer equipped with an air-acetylene burner.
- 2.3 Zinc hollow cathode lamp.

3. Reagents

The water used must be double distilled in borosilicate glass apparatus or of an equivalent degree of purity.

- 3.1 Standard solution containing zinc, 1 g/L
Use of a commercial standard zinc solution is preferred. Alternatively this solution may be prepared by dissolving 4.3975 g of zinc sulfate, $ZnSO_4 \cdot 7H_2O$, in water and making up the volume to one liter.
- 3.2 Dilute standard solution containing 100 mg of zinc per liter.

4. Procedure

4.1 Preparation of sample

Remove the alcohol from 100 mL of wine by reducing the volume of the sample to half its original value using a rotary evaporator (50 to 60 °C). Make up to the original volume of 100 ml, with double distilled water.

4.2 Calibration

Place 0.5, 1, 1.5 and 2 ml, of the solution containing 100 mg zinc per liter into each one of four 100 mL volumetric flasks and make up to the mark with double distilled water. The solutions prepared in this way contain 0.5, 1, 1.5 and 2 mg of zinc per liter respectively.

4.3 Determination

Set the absorbance wavelength to 213.9 nm. Zero the absorbance scale using double distilled water. Aspirate the wine directly into the burner of the

spectrophotometer, followed in succession by the four standard solutions. Record the absorbance and repeat each measurement.

5. Expression of results

5.1 Method of calculation

Plot a graph giving the variation in absorbance as a function of zinc concentration in the standard solutions. Record the mean value of the absorbance obtained with the diluted wine sample on this graph and determine its zinc concentration to one decimal place.

Method OIV-MA-AS322-09

Type IV method

Silver

1. Principle

The method is based on the use of atomic absorption spectrophotometry after ashing the sample.

2. Apparatus

- 2.1 Platinum dish.
- 2.2 Water bath, thermostatically controlled to 100 °C
- 2.3 Furnace set at 500 to 525 °C.
- 2.4 Atomic absorption spectrophotometer.
- 2.5 Silver hollow cathode lamp.
- 2.6 Gas supplies: air, acetylene.

3. Reagents

- 3.1 Silver nitrate, AgNO₃.
- 3.2 Nitric acid, ($\rho_{20} = 1.38$ g/mL), 65%.
- 3.3 Nitric acid, diluted 1/10 (v/v) with distilled water.
- 3.4 Solution containing 1 g of silver per L.

Use of a standard commercial silver solution is preferred. Alternatively this solution may be prepared by dissolving 1.575 g of silver nitrate in dilute nitric acid and making up to a volume of 1,000 mL with dilute nitric acid (3.3).

- 3.5 Solution containing 10 mg of silver per L.

Take 10 mL of the 1 mg/L solution and make up to 1 L with dilute nitric acid.

4. Procedure

4.1 Preparation of sample

Place 20 mL of the sample in a platinum dish and evaporate to dryness over a boiling water bath. Ash in the furnace at a temperature of 500 to 525 °C. Moisten the white ash with 1 mL of concentrated nitric acid (3.2). Evaporate over a boiling water bath, repeat the addition of 1 mL nitric acid (3.2) and evaporate a second time. Add 5 mL of dilute nitric acid (3.3) and heat gently until dissolved.

4.2 Calibration

Pipette 2, 4, 6, 8, 10 and 20 mL of solution (3.5) respectively into each of size 100 mL volumetric flasks and make up to the mark with dilute nitric acid (3.3): the solutions contain 0.20, 0.40, 0.60, 0.80, 1.0 and 2.0 mg of silver per liter respectively.

4.3 Set the absorbance wavelength to 328.1 nm. Adjust zero using double distilled water. Measure the absorbance directly of successive standard solutions (4.2) and carry out in duplicate.

5. Expression of results

Plot a graph showing the variation in absorbance as a function of the silver concentration in the standard solutions.

Using the measured absorbance of the sample read the concentration C in mg/L from the calibration curve.

The concentration of silver in the wine is given in milligrams per liter by

$$0.25 \times C.$$

It is quoted to two decimal places.

Note: Select the concentration of the solutions for the preparation of the calibration curve. The volume of sample taken and the final volume of the liquid should be appropriate for the sensitivity of the apparatus to be used.

Method OIV-MA-AS322-10

Type IV method

Cadmium

1. Principle

Cadmium is determined directly in the wine by graphite furnace atomic absorption spectrophotometry.

2. Apparatus

All the glassware must be washed in concentrated nitric acid prior to use, heated to 70 to 80 °C and rinsed in double distilled water.

- 2.1 Atomic absorption spectrophotometer equipped with a graphite furnace, background correction and a recorder.
- 2.2 Cadmium hollow cathode lamp
- 2.3 5 µl micropipettes with special tips for atomic absorption measurement.

3. Reagents

The water used must be double distilled prepared using borosilicate glass apparatus, or water of a similar purity. All reagents must be of recognized analytical reagent grade and, in particular, free of cadmium.

- 3.1 Phosphoric acid ($\rho_{20} = 1.71$ g/mL), 85%.
- 3.2 Phosphoric acid solution obtained by diluting 8 mL of phosphoric acid with water to 100 mL.
- 3.3 0.02 M Ethylenediaminetetraacetic acid disodium (EDTA) solution.
- 3.4 pH 9 buffer solution: dissolve 5.4 g of ammonium chloride in a few milliliters of water in a 100 mL volumetric flask, add 35 mL of 25% (v/v) ammonium hydroxide solution. Ammonium hydroxide solution, $\rho_{20} = 0.92$ g/mL, diluted to 25% (v/v) and made up to 100 mL with water.
- 3.5 Eriochrome black T, 1% (m/m) solution in sodium chloride.
- 3.6 Cadmium sulfate, $3\text{CdSO}_4 \cdot 8\text{H}_2\text{O}$.

The concentration of the cadmium sulfate must be verified using the following method:

Weigh exactly 102.6 mg of the cadmium sulfate sample into a beaker with some water and shake until dissolved; add 5 mL of the pH 9 buffer solution

and approximately 20 mg of Eriochrome black T. Titrate with the EDTA solution (3.3) until the indicator begins to turn blue.

The volume of EDTA added must be equal to 20 mL. If the volume is slightly different, correct the weighed test portion of cadmium sulfate used in the preparation of the reference solution accordingly.

3.7 Cadmium reference solution at 1 g per liter.

Use of a standard commercial solution is preferred. Alternatively this solution may be prepared by dissolving 2.2820 g of cadmium sulfate in water and making up to one liter. Keep the solution in a borosilicate glass bottle with a ground glass stopper.

4. Procedure

4.1 *Preparation of the sample*

The wine is diluted 1/2 (v/v) with the phosphoric acid solution (3.2).

4.2 *Preparation of calibration standards*

Using the cadmium reference solution, prepare successive dilutions 2.5, 5, 10 and 15 µg of cadmium per liter respectively.

4.3 *Determination*

4.3.1 Furnace Programming (for guidance only):

Dry at 100°C for 30 seconds

Mineralize at 900 °C for 20 seconds

Atomize at 2250 °C for 2 to 3 seconds

Nitrogen flow (flushing gas): 6 liters/minute

Note: At the end of the procedure, increase the temperature to 2700 °C to clean the furnace.

4.3.2 Atomic absorption measurements

Select an absorption wavelength of 228.8 nm. Set the zero on the absorbance scale with double distilled water. Using a micropipette, introduce into the furnace three 5 µl portions of each of the solutions in the calibration range and the sample solution to be analyzed. Record the absorbance measured. Calculate the mean absorbance value from the results for the three portions.

5. Expression of results

5.1 *Method of calculation*

Draw the absorbance variation curve as a function of the concentration of cadmium in the solutions in the calibration range. The curve is linear. Enter the mean absorbance value of the sample solution on the calibration curve and obtain the cadmium concentration C. The cadmium concentration expressed in micrograms per liter of wine is equal to 2C.

BIBLIOGRAPHY

- MEDINA B., *Application de la spectrométrie d'absorption atomique sans flamme au dosage de quelques métaux dans les vins*, Thèse Doct. en œnologie, Bordeaux II, 1978.
- MEDINA B. and SUDRAUD P., FV O.I.V 1979, n° 695.

Method OIV-MA-AS322-11

Lead

(Resolution Oeno 3/94)

1. Principle of the method

Lead is determined directly in wine by flameless atomic absorption spectrophotometry.

WITHDRAWN

Criteria for the methods of quantification of lead in wine

(Resolution Oeno 7/2006)

1.1 Method Criteria Definitions

Trueness the closeness of agreement between the average value obtained from a large series of test results and an accepted reference value

$r =$ Repeatability limit, the value below which the absolute difference between 2 single test results obtained under repeatability conditions (i.e., same sample, same operator, same apparatus, same laboratory, and short interval of time) may be expected to lie within a specific probability (typically 95%) and hence $r = 2.8 \times s_r$.

$S_r =$ Standard deviation, calculated from results generated under repeatability conditions.

$RSD_r =$ Relative standard deviation, calculated from results generated under repeatability conditions $[(S_r/\bar{x}) \times 100]$, where \bar{x} is the average of results over all laboratories and samples.

$R =$ Reproducibility limit, the value below which the absolute difference between single test results obtained under reproducibility conditions (i.e., on identical material obtained by operators in different laboratories, using the standardised test method), may be expected to lie within a certain probability (typically 95%); $R = 2.8 \times s_R$.

$S_R =$ Standard deviation, calculated from results under reproducibility conditions.

$RSD_R =$ Relative standard deviation calculated from results generated under reproducibility conditions $[(S_R/\bar{x}) \times 100]$

$Ho_R =$ HORRAT value: the observed RSD_R value divided by the RSD_R value calculated from the Horwitz equation [1].

2 Method of analysis to be used by the laboratory and laboratory control requirements

2.1 Requirements

Specific methods for the determination of lead in wine are not prescribed. Laboratories shall use a method (Type II) validated to OIV requirements [2] that fulfils the performance criteria indicated in Table 1 e.g. GFAA or ICP-MS methods are applicable provided they meet the performance criteria outlined below. Wherever possible, the validation shall include a certified reference material in the collaborative trial test materials. If not an alternative estimation of trueness should be used. Examples of suitably validated methods for the determination of lead in wine are provided in Appendices 1 & 2.

2.2 General considerations

All apparatus which comes into contact with the sample shall be made of an inert material (e.g. polypropylene, polytetrafluoroethylene [PTFE], etc.). The use of ceramic materials is not advisable because of the possibility that lead might be present. If it is not certain that the materials available are free from the analytes in question, their use shall be assessed by means of *ad hoc* studies, which should be considered as an integral part of the validation of the method of analysis. All plastic ware including sample containers shall be acid cleaned. If possible, equipment used for preparing samples should be reserved for lead analyses only.

Table 1: Performance criteria for methods of analyses for lead in wine

Parameter	Value/Comment
Applicability	Suitable for determining lead in wine for official purposes.
Detection limit	No more than one tenth of the value of the OIV limit (expressed in µg/L)
Limit of quantification	No more than one fifth of the value of the OIV limit (expressed in µg/L) except if the value of the limit for lead is less than 100 µg/L. For the latter, no more than two fifth of the value of the specification
Precision	HORRAT values of less or equal to 2 in the validation collaborative trial
Recovery	80% - 105% (as indicated in the collaborative trial)
Specificity	Free from matrix or spectral interferences
Trueness	$ \bar{x} - m < 1,96 * \sqrt{S_{R(lab)}^2 - S_{r(lab)}^2} * (1 - 1/n)$ <p>where m is the certified value of the wine reference material and \bar{x} is the average of n measurements of lead content in this wine, within the same laboratory. $S_{R(lab)}$ and $S_{r(lab)}$ are standard deviations, calculated from results within the same laboratory under reproducibility and repeatability conditions.</p>

2.3 Estimation of the analytical trueness and recovery calculations

Wherever possible the trueness of the analyses shall be estimated [3] by including suitable certified reference materials in the analytical run. The analyst shall also take due note of the ‘Harmonised Guidelines for the Use of Recovery Information in Analytical Measurement’ [4] developed under the auspices of IUPAC/ISO/AOAC. The recovery should be approximately 100 % in which case recovery calculations are of minor importance.

References

- [1] W Horwitz, "Evaluation of Analytical Methods for Regulation of Foods and Drugs", *Anal. Chem.*, 1982, **54**, 67A - 76A
- [2] Protocol for the design, conduct and interpretation of method-performance studies, FV 1061, OIV, 1998
- [3] ISO 5725-6:1994, 4.2.3. International Organisation for Standardisation, case Postal 56, CH-1211, Genève 20, Switzerland.
- [4] ISO/AOAC/IUPAC Harmonised Guidelines for the Use of Recovery Information in Analytical Measurement. *Edited* Michael Thompson, Steven L R Ellison, Ales Fajgelj, Paul Willetts and Roger Wood, *Pure Appl. Chem.*, 1999, 71, 337 – 348

EXAMPLE 1

DETERMINATION OF LEAD IN WINE BY ATOMIC ABSORPTION SPECTROMETRY

1 SCOPE AND FIELD OF APPLICATION

The method can be used for red, white, still, sparkling and fortified wines.

2 DEFINITION

The lead content of wine: the content of lead determined by this procedure expressed as mg/L.

3 PRINCIPLE

Wine is diluted by a matrix matching cocktail and the lead concentration measured directly by graphite furnace atomic absorption spectrometry (GFAAS). A matrix matching mixture is added to both the wine to be determined and the lead calibration standard solutions. This mixture contains both GFAAS 'matrix modifiers' and wine simulating components. Their purpose is to 'modify' the matrices so that the same shape absorption vs. time profile is obtained from both standard solutions and sample solutions during the graphite furnace atomisation stage.

A delayed atomisation mechanism is required e.g. L'vov platform.

The exact composition of the diluent may need to be adjusted to suit particular models of graphite furnace instruments. Before the method is applied experiments must be conducted to check the absorbance vs. time profiles produced by standards and samples and necessary adjustments made to the diluent. The instrument used must be capable of monitoring the absorbance vs. time profile during atomisation. The profile should be such that standards and samples perform alike and that the lead atomisation peak precedes the bulk of the background non-specific absorption enabling the background correction mechanism employed to operate effectively. Examples of matched profiles are given in Annex 2.

4 REAGENTS

Chemicals should be of the highest quality available in terms of being free of lead. Deionised distilled water, or water of equivalent purity, is to be used. Unless otherwise indicated all solutions are prepared fresh daily.

4.1 Diluent solution

NOTE 1: The exact composition of the diluent used may need adjustment to suit the specific model of instrument and graphite furnace employed. If problems are experienced with the suggested modifier composition adjust the phosphate and nitrate concentrations to give:

i) a stable element signal at the optimum ashing temperature and

ii) atomisation with a single reproducible analyte peak which is time separated from the background signal.

Equipment with VDU facilities will allow analysts to confirm time separation of the sample and background peaks (See Annex). The following is an example of a technique for determining the absorbance versus time profile:

Measure the full peak width at half maximum height (FWHM) of a sample peak and compare it to the FWHM of a calibration standard with a similar maximum absorbance. If the peak shapes are visibly different then the composition of the matrix modification modifier needs to be adjusted.

The following are examples of diluents utilised for:

(a) a Perkin-Elmer 3030 equipped with deuterium arc background corrector with an HGA 500 furnace; and (b) a Thermo-Electron Video 12E equipped with Smith-Hieftje background corrector, a CTF 188 furnace and a FASTAC sample deposition system.

4.1.1 Perkin-Elmer 3030 diluent:

To 187 g of water in a 250 ml plastic bottle (5.1) add 11 g ethanol (4.1.3.), 1.1 g of glucose (4.1.4.), 1.1 g of fructose (4.1.5.) and 0.28 g of sodium chloride (4.1.6.). Shake to dissolve the solids. Then add 22 ml nitric acid (4.1.7.) and 4.4 g ammonium dihydrogen orthophosphate (4.1.8.). Shake until all the phosphate has dissolved. Finally add 0.88 g magnesium nitrate (4.1.9.) and shake again until no undissolved solid remains.

4.1.2 *Thermo-Electron Video 12E diluent:*

As above but only 0.66 g of ammonium dihydrogen orthophosphate (4.1.8.) and 0.44 g magnesium nitrate (4.1.9.) are used.

4.1.3 *Ethanol (absolute)*

4.1.4 *D-glucose*

4.1.5 *D(-)fructose*

4.1.6 *Sodium chloride*

4.1.7 *Nitric acid (concentrated)*

4.1.8 *Ammonium dihydrogen orthophosphate*

4.1.9 *Magnesium nitrate hexahydrate*

4.2 10% ethanol (v/v)

To 180 ml water in a 250 ml plastic bottle (5.1.) add using a pipette 20 ml of ethanol (4.1.3.) and shake to mix.

4.3. Lead standard solutions

4.3.1. *Lead standard solution (1000 mg/l)*

4.3.2 *Lead standard solution (10.00 mg/l)*

Into a 100 ml volumetric flask (5.2.) pipette (5.7.) 1.00 ml of lead standard solution (4.3.1.). Dilute to volume with water and mix thoroughly.

NOTE 2 : Check calibration of pipette immediately prior to use.

4.3.3 *Lead working standard (1.00 mg/l)*

Into a 100 ml volumetric flask (5.2.) weigh out 10.00 g of the lead stock solution (4.3.2.) using a Pasteur pipette (5.3.). Wash the inside neck of the volumetric flask with water, add 1 ml of nitric acid (4.1.7.) and make up to the mark with water. Shake to mix thoroughly.

4.3.4. *Lead calibration solutions.*

The eight calibration standards are made up in universal containers (5.4.). A range of 0 to 50 µg/l is covered by the standards. They are 0.0, 2.5, 5.0, 10.0, 20.0, 30.0, 40.0 and 50.0 µg/l. A ninth container is used to prepare a reagent blank.

Rinse out the inside of each container three times with water and shake dry; rinse the caps three times and shake dry. Leave the capped containers standing upright for 5-10 minutes and then shake out residual liquid. Pipette (5.8) into the 9 containers, in order: 5.00, 5.00, 4.95, 4.90, 4.80, 4.60, 4.40, 4.20 and 4.00 ml of water. Into each of the containers pipette (5.8.) 5.00 ml of 10 % ethanol (4.2) followed by two 5.00 ml aliquots of diluent (4.1).

Into the 9 containers pipette (5.6) (5.7) in order: 0 (reagent blank), 0, 50, 100, 200, 400, 600, 800 and 1000 µl of working standard (4.3.3). Cap the containers and shake to mix the contents. Prepare fresh for each batch of samples.

4.4 1 % (v/v) nitric acid.

5. APPARATUS

All glass and plastic ware used must be acid cleaned (soaked in 20 % nitric acid for at least 24 hours), rinsed thoroughly with distilled water prior to use and kept covered (with cling-film if appropriate) to prevent aerial contamination.

5.1 250 plastic bottles, with caps (for example: Nalgene or equivalent).

5.2 Volumetric flasks, 100 ml (Grade A).

5.3 Pasteur pipettes, with teats

5.4 Universal containers, 30 ml (Nunc, Sterilin or equivalent).

5.5 Glass beakers, 600 ml.

5.6 Pipette*, 40 - 200µl (Labsystems FinnpiPETTE or equivalent).

5.7 Pipette*, 200 - 1000µl (Labsystems FinnpiPETTE or equivalent).

5.8 Pipette*, 0.5 - 5.0 ml (Labsystems FinnpiPETTE or equivalent).

5.9 Pipette*, 2.0 - 10.0 ml (Labsystems FinnpiPETTE or equivalent).

COMPENDIUM OF INTERNATIONAL ANALYSIS OF METHODS - OIV
Criteria for the methods of quantification of lead

**NOTE 3: pipettes should be calibrated each day (of use).*

- 5.10 Analytical balance, (+ or - 1 mg, Mettler PC440 or equivalent).
- 5.11 Vortex type mixer or equivalent.
- 5.12 Test tubes, 20 ml capacity.
- 5.13 Test tube racks, suitable for use with 5.12.
- 5.14 Container racks, suitable for use with 5.4.
- 5.15 Magnetic stirrer.
- 5.16 Magnetic follower, PTFE coated.
- 5.17 Pipette tips, suitable for use with 5.6, 5.7, 5.8 and 5.9
- 5.18 Atomic absorption spectrometer,

Atomic absorption spectrophotometer equipped with a graphite furnace, atomisation delay cuvette, auto-injector, background corrector, and absorbance vs. time profile monitoring facility equivalent to the following. Instrumental conditions should be adjusted appropriately for the model used. **The following are given as examples:**

- (a) Atomic absorption spectrophotometer, Perkin-Elmer 3030 equipped with deuterium arc background corrector for non-specific absorption. Lead hollow cathode lamp operated at 12 mA. Monitor the 283.3 nm line; slit width 0.7 nm. Graphite furnace, HGA 500 fitted with pyrolytically coated graphite tube with a solid pyrolytic graphite L'vov platform resting inside. Use argon as the purge gas. The furnace conditions for the HGA 500 are as follows:

COMPENDIUM OF INTERNATIONAL ANALYSIS OF METHODS - OIV
Criteria for the methods of quantification of lead

Step	1	2	3	4	5	6
Temperature (°C)	200	1100	1100	1800	2400	20
Ramp (s)	5	20	1	0	1	1
Hold (s)	60	20	2	3	6	25
Gas	Ar	Ar	Ar	Ar	Ar	Ar
Gas flow (mL/min)	50	50	0	0	300	300
Read (2.5s integration)				X		

Auto-sampler/injector, AS 40. 20 µl injection volume, 3 injections per tray position.

(b) Thermo-electron Video 12E Atomic absorption spectrophotometer used with a CTF 188 Graphite Furnace and a FASTAC sample deposition system with the following conditions:

(c)

Step	1	2	3	4	5
Temperature (°C)	150	350	650	100 0	240 0
Ramp (s)	0	30	15	1	
Hold (s)	2	0	5	4	10
Gas	Ar	Ar	Ar	Ar	Ar
Gas flow (mL/min)	50	50	0	0	300
Read (2.5s integration)				X	

Sample deposition 5 s, FASTAC delay time 10 s, with 3 injections per tray position. Monitor the 283.3 nm line.

6. PROCEDURE

6.1. Preparation of wine

Shake the wine container to thoroughly mix the contents before sub-sampling. Sparkling wines should be transferred to a clean beaker and placed in an ultrasonic bath until gas is no longer evolved prior to use.

6.2. Measurement solutions

6.2.1 Wine samples

Into a 20 ml test tube (5.12) pipette (5.8) 2.00 ml of water, 4.00 ml of diluent (4.1) and 2.00 ml of the sample wine. Mix thoroughly using the vortex mixer (5.11).

6.2.2 Recovery estimates

For recovery estimate purposes pipette (5.8) into a 20 ml test tube (5.12) 1.80 ml of water, 4.00 ml of diluent (4.1), 2.00 ml of the sample wine and add using a pipette (5.7) 0.200 ml of lead working standard (4.3.3). Mix thoroughly using the vortex mixer (5.11).

NOTE 4: Any sample that exceeds the highest calibration standard will have to be re-analysed using a smaller sample aliquot. Add extra 10% ethanol (4.2) to the sample volume.

6.3. Measurement

Determinations are carried out in batches. Each batch is to contain at least four replicates of the reagent blank and three spiked replicates of samples for recovery estimate purposes. The lead calibration solutions are distributed evenly amongst the unknowns on the auto-sampler tray. Transfer the samples and standards to the auto-sampler sample containers using a Pasteur pipette (5.3). Discard the first filling of the container and measure the second filling (if there is not enough sample solution, care will have to be taken to ensure that the sample containers are scrupulously clean). Wash the Pasteur pipette four or five times with 1% nitric acid (4.4.) between each standard and sample transfer.

6.4. Quantification of lead

The mean absorbance from 3 injections is used in all cases. Construct a calibration graph from the mean responses given by the in-batch standards. Note the absorbances recorded by the instrument for each sample. The lead concentration of the sample solutions are determined by comparison with the calibration graph.

NOTE 5: It is recommended that the furnace tube and platform be replaced every two batches or sooner if there is a marked decrease in the measured absorbance of the standards.

7 EXPRESSION OF RESULTS

Correct the results for the average in-batch recovery.

7.1 Calculation

Obtain from the calibration graph, the lead content of all the measurement solutions. Calculate the lead content of the wine samples and spiked wine samples using the following calculation:

$$\text{Pb concentration (mg/l)} = \frac{(C_m - C_b) \times V_t}{V_m}$$

where:

C_m is the mean lead concentration of the measurement solution (mg/l).

C_b is the mean measured lead concentration of the reagent blank solutions (mg/l).

V_t is the final total volume of the measurement solution (ml).

V_m is the volume of the wine sample taken (ml).

7.2 Calculation of recovery estimates

$$\text{Recovery (\%)} = \frac{(C_s - C_a) \times V_s \times 100}{S}$$

where:

C is the calculated mean lead concentration of the spiked wine sample (mg/l).

C^S is the calculated mean lead concentration of the unspiked wine (mg/l).

V^a is the volume of wine to which the spike is added (ml).

S is the amount of spike added (μg).

7.3 Calculation of recovery corrected results

$$\text{Corrected Pb concentration (mg/L)} = \frac{C_w \times 100}{R_a}$$

where:

C_w is the calculated lead concentration of the wine sample (mg/l).

R_a is the average in-batch recovery (%).

ANNEX: VALIDATION STUDY

The following study was carried out to internationally agreed procedures (1)(2).

TABLE 1 SAMPLE SCHEME

Sample Code	Sample Description
5 & 9	Bordeaux (Sweet White)
3 & 11	Italian Chardonnay (White)
7 & 8	Spanish Red fortified at 260 µg/l
6 & 10	Romanian Pinot Noir
2 & 12	Romanian Pinot Noir fortified with 150 µg/l
1	Sample 3/11 fortified with 124 µg/l
4	Sample 3/11 fortified with 134 µg/l

TABLE II SUMMARY OF STATISTICAL PARAMETERS FOR LEAD IN WINE COLLABORATIVE TRIAL (The results from one laboratory were assessed as being inappropriate for inclusion in the statistical analysis)

Sample	A	B	C	D	E	F	F1
Code	5, 9	3, 11	7, 8	6, 10	2, 12	1	4
n	16	15*	16	16	16	16	
n (-outl)	16	15	14	16	15	16	
Targ.	56	24	279	67	192	143	153
Mean	50.8	27.2	298	70.6	189	143	149
r	23	15	24	32	51	38	
S _r	8.1	5.3	8.7	11.8	18.2	13.6	
RSD _r	16	19	3	17	10	9	
Ho_r	1.0	1.1	0.2	1.1	0.7	0.7	
R	42	25	83	57	154	79	
S _R	15.1	8.8	29.8	20.3	55.2	28.2	
RSD_R	30	28	10	29	29	19	
Ho_R	1.2	1.2	0.5	1.2	1.4	0.9	

KEY TO TABLES I-II

N Initial number of laboratories

n(-outl) Number of laboratories after removal of outliers

(*) Laboratory 17 reported <20 µg/l for test material 11. Their results have not been included in the statistical analysis for this sample (B).

Mean The observed mean, the mean obtained from the collaborative trial data after removal of outliers.

Targ. The mean observed value obtained "in-house" using ICP-MS

r Repeatability limit, the value below which the absolute difference between 2 single test results obtained under repeatability conditions (i.e., same sample, same operator, same apparatus, same laboratory, and short interval of time) may be expected to lie within a specific probability (typically 95%) and hence $r = 2.8 \times s_r$.

S_r The standard deviation of the repeatability.

RSD_r The relative standard deviation of the repeatability ($S_r \times 100/\text{MEAN}$).

Ho_r The observed RSD_r divided by the RSD_r value estimated from the Horwitz equation using the assumption $r=0.66R$.

R Reproducibility limit, the value below which the absolute difference between single test results obtained under reproducibility conditions (i.e., on identical material obtained by operators in different laboratories, using the standardised test method), may be expected to lie within a certain probability (typically 95%); $R = 2.8 \times s_R$.

S_R The standard deviation of the reproducibility (between laboratory variation).

RSD_R The relative standard deviation of the reproducibility ($S_R \times 100/\text{MEAN}$).

Ho_R The observed RSD_R value divided by the RSD_R value calculated from the Horwitz equation.

$$RSD_R = 2(1-0.5\log_{10} C) \quad (\text{where } C = \text{concentration expressed as a decimal})$$

HORRAT⁽⁴⁾ values are:

For repeatability, the observed RSD_r divided by the RSD_r value estimated from the Horwitz equation using the assumption $r = 0.66R$.

For reproducibility, the observed RSD_R divided by the RSD_R value estimated from the Horwitz equation.

8. REFERENCES

8.1 Paul A. Brereton, Paul Robb, Christine M Sargent, Helen M. Crews and Roger Wood. Determination of Lead in Wine by Graphite Furnace Atomic Absorption Spectrometry: Interlaboratory Study. *JAOAC Int.*, 1997, **80**, No 6,

1287-1297.

8.2 "Protocol for the Design, Conduct and Interpretation of Collaborative Studies." Editor W Horwitz, Pure & Appl. Chem., Vol. 67, No., 2, pp.331-343, 1995

8.3 Horwitz W, Evaluation of Methods Used for Regulation of Foods and Drugs, *Analytical Chemistry*, 1982, **57**, 67A-76A.

8.4 Peeler J T, Horwitz W and Albert R, Precision Parameters of Standard Methods of Analysis for Dairy Products, *JAOAC*, 1989, 72, No 5, 784-806.

Annex

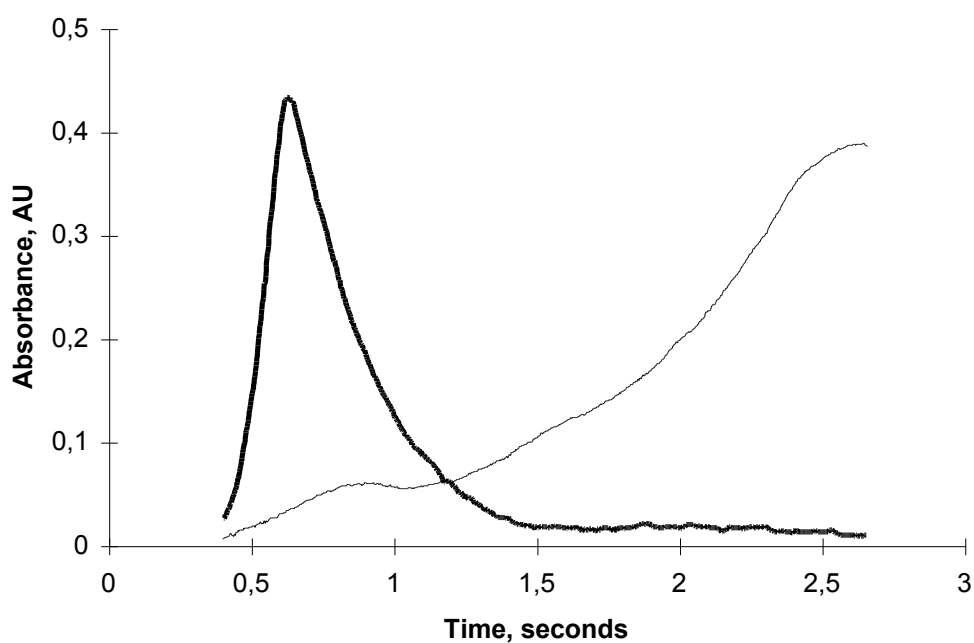

Absorbance vs. Time profiles for the measurement of lead in wine
using a Perkin-Elmer 3030 atomic absorption spectrometer
with deuterium arc background correction.

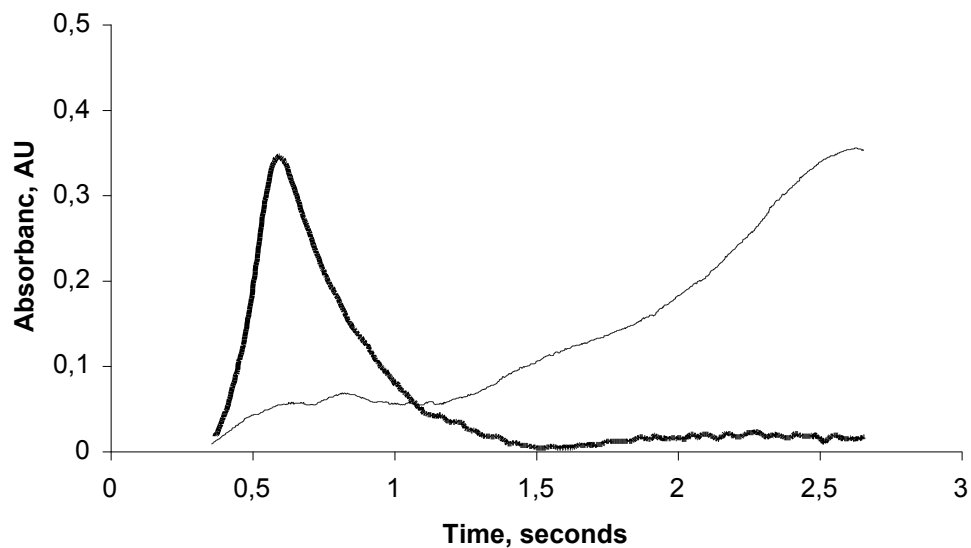

(i) 30 ng/l wine standard



(ii) wine sample

Key:  corrected absorbance,  background absorbance

EXAMPLE 2

DETERMINATION OF LEAD IN WINE BY ATOMIC ABSORPTION SPECTROMETRY

1. FIELD OF APPLICATION :

This analysis method can be applied to all types of wine, given the maximum limit set by the O.I.V.

2. REFERENCES:

- 2.1. Journal Officiel des Communautés Européennes (3 octobre 1990). *Méthode de dosage du plomb dans le vin* (p. 152 et 153).
- 2.2. Teissèdre P.L., Brun S., Médina B. (1992). *Dosage du plomb dans les vins / Proposition de modifications à la méthode du Recueil*. Feuille Vert de l'O.I.V., n°928, 1997/151292.
- 2.3. Moreira Balio da Silva M., Gaye J., Médina B. (1996). *Comparaison de six méthodes de dosage du plomb dans les vins par absorption atomique en four graphite*. Feuille Vert de l'O.I.V. n° 1013, 2310/190196.
- 2.4. Brereton P., Robb P., Sargent C., Crews H., Wood R. (1996). *Validation of a graphite furnace atomic absorption spectrometry method for the detection of lead in wine*. Feuille Vert de l'O.I.V. n° 1016, 2913/230196.
- 2.5. Bourguignon J.B., Douet Ch., Gaye J., Médina B. (1997). *Dosage du plomb dans le vin / Interprétation des résultats de l'essai interlaboratoire*. Feuille Vert 1055 de l'O.I.V. n° 2456/190397.

3. PRINCIPLE:

The wine will undergo no preparations, except dilution in the case of white sweet wines.

Adding ammonium dihydrogenophosphate enables the lead contained in wine to be stable at high temperatures, which leads to eliminating interferences – and to acting in an identical manner to the standard solution.

The atomizer is a pyrolytic graphite equipped with a platform heated by the Joule effect.

The wavelength of the ray used is 283.3 nanometres.

The non specific absorption correction can be done by the Zeeman effect or by using a deuterium discharge lamp.

The type of lead determination in wine is a direct dosage method with external calibration.

4. REAGENTS

4.1. Demineralised water: ultra pure; with resistivity above 18 MΩ/cm.

4.2. Nitric acid: 65 % ; « suprapur » quality acid.

4.3. Ammonium dihydrogeno-phosphate NH₄H₂PO₄ for analysis.

4.4. Lead standard solution: at 1000 µg/ml (or 1 g/l) in 2% nitric acid (commercial solution, ready to use).

5. APPARTUS

5.1 Analytic balance (e = 1 mg).

5.2 Glass ware:

5.2.1 Volumetric flask 50, 100 ml (class A),

5.2.2 Volumetric pipette 1, 10 ml (class A),

5.2.3 Decontamination of glassware used: rinse in demineralised water; soak at least 24 hours in a basin of 10% nitric acid; rinse two times in demineralised water.

5.3 Atomic absorption spectrophotometer equipped with a graphite tube atomizer for non-specific absorption correction and an auto-sampler (rinse the sampler buckets with 10% nitric acid).

5.3.1. Pyrolytically coated graphite furnace containing an L'Vov platform possibly tantalite (reference 9.1 – see below):

5.3.1.1 Tantalum solution: place 3 g of tantalum powder (metal tantalum with a purity above 99.7%) in a 100 ml teflon cylindrical flask; add 10 ml of diluted fluorhydric acid (1 + 1), 3 g of dehydrated oxalic acid and 0.5 ml of 30% hydrogen peroxide solution; heat together carefully to dissolve metal; add hydrogen peroxide when r reaction slows down. Add 4 g of dehydrated oxalic acid and approximately 30 ml of demineralised water when completely

dissolved. Dissolve acid. Fill the solution up to 50 ml. This solution is stored in a plastic flask.

5.3.1.2 Tantalisation of a platform: the platform is placed inside the graphite tube. These items are placed together on a spectrophotometer atomization unit. 10 µl tantalum solution is injected on a platform using an auto-sampler. The temperature cycle is set according to the following program: drying at 150°C for 40 s; mineralization at 900°C for 60 s; atomization at 2600°C for 2.5 s. Argon is used as an inert gas.

6. PROCEDURE

6.1 Test portion: The neck of the wine bottle with a tinned lead capsule must be carefully cleaned before uncorking.

6.2 Sample preparation: In general, no preparation of wine is necessary; samples are placed directly in the automatic sampler buckets. Cloudy wine needs to be filtered. To prolong the utilisation period of the platforms, sweet white wines are diluted for sugar contents between 10 to 50 g/L, dilute by 1/2; for contents above 50 g/l, dilute by 1/4.

6.3 Preparation of solutions:

6.3.1 *White dilution*:

The solution is used as an additional volume to be injected and is made up of demineralised water containing 1 % nitric acid (4.2.).

6.3.2 *Matrix modifying agent*:

Into a 50 ml flask (5.2.1) introduce 3 g of ammonium dihydrogeno-phosphate (4.3.); dissolve and fill with demineralised water (4.1.).

6.3.3 *10 mg/ of lead solution*:

Into a 100 ml flask (5.2.1) place 1 ml of 1 g/l (4.4.) solution; add 1 % nitric acid (4.2.); fill to volume with demineralised water (4.1.). This solution can be kept one month at a temperature + 4°C.

6.3.4 *100 µg/L lead solution*:

Into a 100 ml flask (5.2.1) place 1 ml of 10 mg/l (6.3.3.) lead solution; fill to volume with demineralised water (4.1.). This solution must be prepared every analysis day.

COMPENDIUM OF INTERNATIONAL ANALYSIS OF METHODS - OIV
Criteria for the methods of quantification of lead

6.3.5 *Calibration scale* (for information purposes): 0 ; 16.7 ; 33.3 et 50 µg/l (see Table II).

6.4 Calibration and determination:

6.4.1 *Spectrometric measurement:*

6.4.1.1 wavelength: 283.3 nm;

6.4.1.2 slot with: 0.5 nm;

6.4.1.3 hollow cathode lamp intensity: 5 mA ;

6.4.1.4 correction continuum: by Zeeman or deuterium effect;

6.4.1.5 introduction of standards heated and samples in a graphite furnace using an automatic sampler. The flushing liquid is made up of 500 ml of demineralised water containing a drop of Triton X 100.

Note: in order to inject at 90°C on a platform, the furnace temperature should be regulated to approximately 150°C.

6.4.1.6 signal measurement: peak height;

6.4.1.7 Duration of measurement: 3 seconds;

6.4.1.8 Number of measurements by standard or sample: 2

Note: the average of these two determinations constitutes the trial result. If the variation coefficient for the two determinations is greater than 15 %, the two other determinations must be re-done.

6.4.1.9. Furnace parameters (for information purpose): see Table I.

Table I – Furnace parameters				
For determination of lead in wine				
Temperature (in °C)	Duration (in s)	Gas type	Gas flow (in l/mn)	lecture du signal
150	60	argon	3.0	
750	10	argon	3.0	
750	30	argon	3.0	
750	2	argon	0	
2400	1	argon	0	oui
2400	2	argon	0	oui
2400	2	argon	3.0	
40	20	argon	3.0	

6.4.1.10. Automatic sampler parameters (for information purposes): see Table II.

Table II – Sampler parameters for the dosage of lead in wine				
Analysis:	volumes injected in μl			
	sample	Pb solution 100 $\mu\text{g/l}$	"white" dilution	Matrix modifier
Calibration blank	0	0	5	1
Standard 1	0	1	4	1
Standard 2	0	2	3	1
Standard 3	0	3	2	1
Sample	2	0	3	1

6.4.2 *Tracing of calibration curve:* the automatic distributor cycle enables the preparation of standards from 100 $\mu\text{g/l}$ (Table II) lead solutions. The calibration graph is drawn up: absorbency according to lead concentration in micrograms per litre.

7. EXPRESSION OF RESULTS

7.1 Concentration of lead in injected solution: This is obtained from calibration curve (6.4.2.).

7.2 Concentration of lead in wine: This is calculated by multiplying by 3 the result given in 7.1. (2 μl of solution injected for a final volume of 6 μl on the platform). Take into account the possible dilution of wines (in the case of sweet white wines).

7.3 Result: is expressed in milligrams of lead per liter of wine (mg/l), to two digits.

8. INTER-LABORATORY TRIALS

A "double-blind" trial was carried out on 8 different wines obtained from mixtures of Bordeaux wines: two red wines (R1 and R2), two rosé wines (Ro1 and Ro2), two dry white wines (Bs1 and Bs2) and two sweet white wines (D1 and D2). Eleven Spanish, Portuguese, Moroccan and French laboratories participated by determining lead in 16 samples received.

8.1 Presentation of 8 wine samples:

Table III: Characteristics of wine used in interlaboratory trials

Wine	Type	T.A.V. (% Vol.)	Total acidity (g/l H ₂ SO ₄)	Volatile acidity (g/l H ₂ SO ₄)	Reducing sugar (g/l)
R1	Red	11,86	4,43	1,57	1,2
R2	Red	12,54	3,77	0,34	1,5
Ro1	Rosé	12,23	5,30	0,44	1,2
Ro2	Rosé	11,43	4,88	0,45	1,1
Bs1	Dry white	11,65	4,62	0,37	2,2
Bs2	Dry white	12,32	4,57	0,31	0,9
D1	Sweet white	12,94	3,72	0,67	76,4
D2	Sweet white	12,66	4,70	0,45	62,8

COMPENDIUM OF INTERNATIONAL ANALYSIS OF METHODS - OIV
Criteria for the methods of quantification of lead

8.2 Statistics of results:

Table IV: Statistical analysis of inter-laboratory trial results

Wine sample	R1	R2	Ro1	Ro2	Bs1	Bs2	D1	D2
Double-blind repetitions	C & K	F & I	D & G	J & L	B & H	P & N	A & E	M & O
Initial number of laboratories	11	11	11	11	11	11	11	11
Number of laboratories After elimination of large variances	11	10	11	11	10	10	11	10
Average ($\mu\text{g/l}$)	44	162	28	145	52	138	60	145
Repeatability limit r	18	12	7	17	6	13	28	7
Standard deviation of repeatability S_r	6,4	4,3	2,5	6,1	2,1	4,6	10	2,5
Relative standard deviation of reproducibility RSD_r (en %)	14,5	2,8	9,2	4,2	4,2	3,4	16,5	1,8
Horvat value (Ho_r): Observed RSD_r / RSD_r Horwitz	0,6	0,1	0,3	0,2	0,2	0,2	0,7	0,1
Reproducibility limit R	34	105	23	86	30	101	86	144
Standard deviation of reproducibility S_R	12,3	37,5	8,2	30,8	10,7	35,9	30,6	51,6
Relative standard deviation of reproducibility RSD_R (en %)	28	23,1	29,3	21,2	20,6	26	51	35,6
Horvat values (Ho_R): Observed RSD_R / RSD_R Horwitz	1,1	1,1	1,1	1	0,8	1,2	2,1	1,7

Out of the 11 laboratories which participated in the trial, 7 declared that they had followed the proposed method and 4 modified some of the parameters.

9. METHOD PERFORMANCES AND QUALITY CONTROL

9.1 Detection limit: This is determined from a series of 20 blank analytical repetitions and is equal to 3 standard deviations. In the case of the proposed method a series of 20 blank analytical measurements resulted in: average = 1,29 µg/l ; standard deviation = 0,44 µg/l ; detection limit = 1,3 µg/l .

9.2 Limit of quantification: This is equal to 3 times the detection limit. In the case of the proposed method, the limit of quantification is 4 µg/l (3 * 1,32 = 3,96).

9.3 Trueness: The confidence interval for the average of a series of results is compared to the reference material data.

Three reference materials are used including: red wine, dry white wine, sweet white wine for which lead concentrations are certified by the B.C.R. (Bureau Communautaire de Référence) in 1992.

Table V. Trueness of the method

		Red wine BCR E	Dry white wine BCR C	Sweet white wine BCR D
Lead concentration	Certified value (B.C.R. 1992)	36,1 ± 4,9	65,1 ± 9,1	132,4 ± 32
(µg/l)	Average value (series: 10 results)	41,0 ± 3,8	66,0 ± 4,4	128,3 ± 14,1

9.4 Control card

A control card can be drawn up for each reference material used. Control limits are equal to: +/- 2 S_Rintra (S_R intra: reproductibility standard deviation).

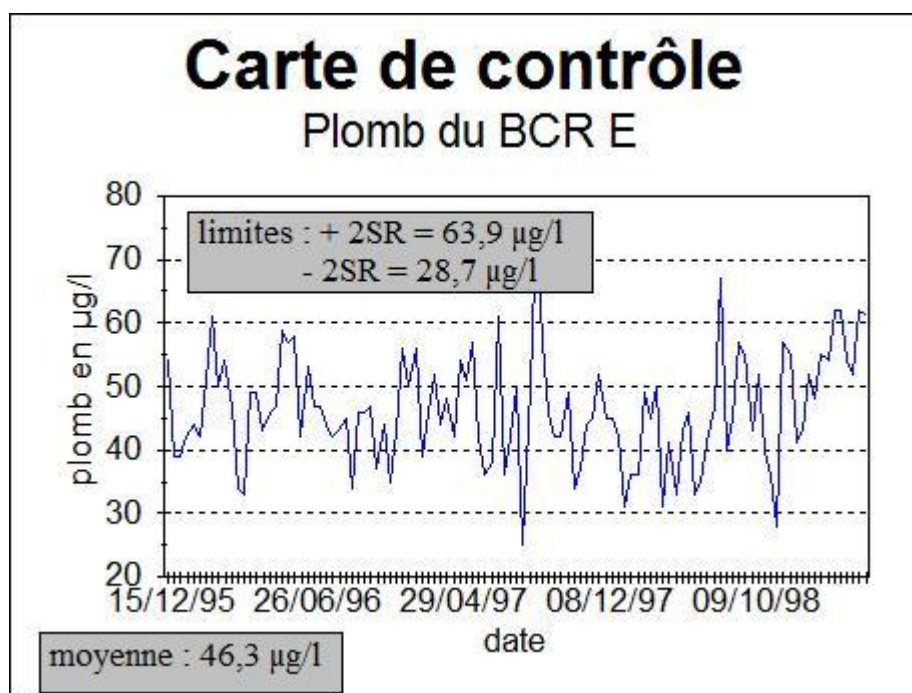

10. BIBLIOGRAPHY

- 10.1. Zátka V. (1978). *Treated graphite atomizer tubes for atomic absorption spectrometry*. Analytical Chemistry, vol. 50, n°3.
- 10.2. US Bureau of Alcohol, Tobacco and Firearms (1991). *Analysis of lead in wines and related products by graphite furnace atomic absorption spectrometry*. Note d'information de l'O.I.V. du 21 août 1991 : « Plomb dans les vins aux U.S.A. ».
- 10.3. Mindak W.R. (1994). *Determination of lead in table wines by graphite furnace atomic absorption spectrometry*. Journal of A.O.A.C. International, vol. 77, n°4, p. 1023-1030.
- 10.4. Médina B. (1994). *Apport de nouvelles techniques au dosage des métaux dans les vins*. Congrès des Œnologues de France à Bordeaux.
- 10.5. Norme française NF ISO 5725-2 (1994). *Application de la statistique : Exactitude (justesse et fidélité) des résultats et méthodes de mesure*.
- 10.6. Jorhem L., Sundström B. (1995). *Direct determination of lead in wine using graphite furnace AAS*. Atomic Spectroscopy, September/October 1995.

Method OIV-MA-AS322-13

Type III method

Analysis of mineral elements in wines using ICP-AES
(inductively coupled plasma / atomic emission spectrometry)
(Resolution Oeno 478/2013)

1. Warning

SAFETY PRECAUTIONS - When handling acids, operators should protect their hands and eyes. Acids must be handled under a suitable hood.

2. Scope

This method specifies an inductively coupled plasma atomic emission spectroscopy (ICP-AES) method to determine the concentration of the following elements in wines:

- Major mineral elements:

- Potassium (up to 1500 mg/L)
- Calcium (up to 250 mg/L)
- Magnesium (up to 150 mg/L)
- Sodium (up to 100 mg/L)

- Minor mineral elements:

- Iron (1 to 10 mg/L)
- Copper (0.1 to 5 mg/L)
- Zinc (0.5 to 5 mg/L)
- Manganese (0.5 to 5 mg/L)
- Strontium (0.1 to 3 mg/L)
- Aluminium (0.75 to 7.5 mg/L)
- Barium (0.1 to 5 mg/L)

3. Principle

3.1 Simultaneous analysis of major and minor elements

A 1:5 dilution is used to prepare the samples in this method in order to be able to analyse both the major and minor elements.

The calibration range contains ethanol (2.5%) to take into account the matrix effects related to its presence during nebulisation and at the plasma temperature, along with nitric acid (HNO₃ - 1%) which is used to stabilise the solutions.

The lines Sc _{335.372} (scandium at 5 mg/L) and Cs _{697.327} (caesium as 1% in CsNO₃) proposed in this method can be used as an internal standard in order to minimise the impact of other non-spectral interferences.

Other internal standards, chosen wisely, may also be used in order to optimise the method, such as Y _{371.029}.

Caesium, in the form of CsNO₃, also serves as an ionic buffer when used as an internal standard. The presence of this buffer therefore sets the ionisation balances of the other components. Caesium chloride, CsCl, can also be used as an ionic buffer.

The internal standards and ionic buffer are prepared in the same flask and then introduced into the sample through the addition of a third channel in the peristaltic pump before entering the nebuliser as a homogenous mixture.

3.2 Analysis of the major elements only

The analysis of the major elements only can also be performed by carrying out a 1:50 dilution of the sample. Nitric acid (HNO₃ - 1%) is added into the standards and the samples in order to stabilise the solutions.

Given the dilution performed, the matrix effects are considered negligible. The use of internal standards will not be necessary. Likewise, there will be no need to add ethanol to the calibration range.

4. Reagents and solutions

Unless otherwise specified, all the reagents used must be of a recognised analytical quality.

- 4.1 Ultra-pure, demineralised water with a resistivity (greater than 18 MΩ), in accordance with the ISO 3696 standard.

COMPENDIUM OF INTERNATIONAL ANALYSIS OF METHODS - OIV
Analysis of mineral elements in wines using ICP-AES (inductively
coupled plasma / atomic emission spectrometry)

- 4.2 Certified mono-element solution(s) (to 1000 or 10,000 mg/L) for the mineral elements analysed and the internal standard (scandium for example).
- 4.3 Internal control: certified reference material (wine) or sample from an intercomparison programme between laboratories, comprising the elements analysed.
- 4.4 Nitric acid of a concentration greater than 60% (for trace analysis) (CAS No. 7697-37-2).
- 4.5 Ethanol of a concentration greater than 95% (for trace analysis) (CAS No. 64-17-5).
- 4.6 A solution of 1% nitric acid
Prepare a 1% nitric acid solution by adding 10 mL of nitric acid (4.4) into a 1000 mL flask.

5. Apparatus and equipment

5.1 Optical emission spectrometer with excitation by induced argon plasma and dispersive system (for wavelength analysis, see table in section 7) with axial, radial or dual configuration and preferably sequential PM, CCD, CID or SCCD type detector.

Note 1: Multi-element analysis using a simultaneous type spectrometer is strongly advised if an internal standard is used in the method.

Note 2: Other systems for introducing the sample may be used in order to increase the sensitivity and robustness of the method (continuous flow injection system, microwave desolvation system (MWDS), etc.).

5.2 Calibrated micropipettes making it possible to take volumes from 200 µL to 5 mL and/or class A 1.5 and 10 mL graduated pipettes.

5.3 Class A volumetric flasks

Note 3: The equipment in contact with the sample must remain in the nitric acid solution (4.4) at a concentration of 10% for 12 hours and then be rinsed several times with the demineralised water (4.1).

In order to assess the robustness of the method on the instrument used, it is recommended that the Mg 279.800/Mg 285.213 intensity ratio is calculated; Mg 285.213 being an atomic line and Mg 279.800 being an ionic line.

6. Sample preparation

6.1 Preparing the calibration range

The number of calibration solutions depends on the reliability required. At least five calibration solutions are needed. The reliability and accuracy of the results can be verified by analysing a reference material.

The range will be chosen according to the dilution performed. It should cover the scope of the various elements. It is important that the nitric acid concentration is the same in the standards and samples.

6.1.1 Preparing a standard solution for simultaneous analysis of major and minor elements (1:5 dilution):

Using a micropipette (5.2), introduce the desired volume of standard, 2.5 mL of ethanol (4.5) and 1 mL of nitric acid (4.4) into a 100 mL flask (5.3). Make up to 100 mL with demineralised water (4.1) and mix.

6.1.2 Preparing a standard solution for analysing major elements only (1:50 dilution):

Using a micropipette (5.2), introduce the desired volume of standard into a 100 mL flask (5.3), make up to 100 mL with nitric acid solution (4.6) and mix.

6.2 Preparing the test samples

6.2.1 Preparing test samples for simultaneous analysis of major and minor elements (1:5 dilution):

Using a graduated pipette or micropipette (5.2), introduce 10 mL of sample and 1 mL of nitric acid (4.4) into a 50 mL flask (5.3). Make up to 50 mL with demineralised water (4.1) and mix.

Sparkling wine samples must be subjected to degassing using an ultrasound bath for example, for at least 10 minutes.

Particularly for samples rich in sugar, mineralisation by microwave digestion in nitric acid is used to destroy organic compounds. Finally, a higher dilution may need to be considered due to a concentration which is too high for certain elements. In this case, the ethanol content may be adjusted accordingly in the solutions and standards.

Note 4: Depending on the robustness of the instrument used and given the use of the ionic buffer and internal standards, it is possible to work with a 1:2 dilution factor in order to improve the sensitivity of the method for trace elements. As a

**COMPENDIUM OF INTERNATIONAL ANALYSIS OF METHODS - OIV
Analysis of mineral elements in wines using ICP-AES (inductively
coupled plasma / atomic emission spectrometry)**

result, the calibration ranges, ethanol content and possibly the experimental parameters (power) must be modified.

6.2.2 Preparing test samples for analysing major elements only (1:50 dilution)

Using a graduated pipette or micropipette (5.2), introduce 1 mL of wine sample and 0.5 mL of nitric acid (4.4) into a 50 mL flask (5.3). Make up to 100 mL with demineralised water (4.1) and mix.

7. Procedure

Experimental parameters

The optimal instrument parameters that have enabled us to achieve the specificity for this method in terms of repeatability and reproducibility are described below. They are presented here as an example and may be modified depending on the instrument used.

Power: 1.3 kW

Plasma gas flow: 15 L/min

Auxiliary gas flow: 1.5 L/min

Nebuliser pressure: 200 kPa

Stabilisation period: 20 s

Measurement time per replicate: 5 s

Pump speed: 15 rpm

Rinsing time: 30 s

Internal standard inlet internal diameter: 0.51 mm

Sample inlet internal diameter: 0.8 mm

Turn the unit on (pump operational and plasma switched on) and clean the system for at least 20 minutes with 1% nitric acid (4.6).

Analyse a blank following the series of standards in increasing order of concentration. A reference sample (4.3) can be used as internal quality control to verify that the calibration is satisfactory. Next, analyse the blank again to ensure the absence of memory effect. Next, conduct the analysis of the samples by inserting a quality control every 10 samples and at the end of the analysis series.

A control chart can be drawn up from the results obtained in relation to the control sample in order to define the acceptance criteria and actions to be performed in the event of drift.

COMPENDIUM OF INTERNATIONAL ANALYSIS OF METHODS - OIV
Analysis of mineral elements in wines using ICP-AES (inductively
coupled plasma / atomic emission spectrometry)

The analyses will be performed for each element with a minimum of 3 replicates.

Lines that can be used for the various elements (other lines may be used depending on the equipment).

Elements	Main line ($E_{sum} = E_{exc} + E_{ion}$)	Associated internal standard	Secondary line ($E_{sum} = E_{exc} + E_{ion}$)	Associated internal standard
<u>K</u>	769.897 (I) (1.6 eV)	Cs 697.327	766.491 (I) (1.6 eV)	Cs 697.327
Ca	317.933 (II) (10 eV)	Sc 335.372	315.887 (II) (10.1 eV)	Sc 335.372
Mg	285.213 (I) (4.3 eV)	Cs 697.327	279.800 (II) (10.6 eV)	Sc 335.372
Na	589.592 (I) (2.1 eV)	Cs 697.327		
Fe	259.940 (II) (12.7 eV)	Sc 335.372	239.563 (II) (11.4 eV)	Sc 335.372
Cu	327.395 (I) (3.8 eV)	Cs 697.327	324.754 (I) (3.8 eV)	Cs 697.327
Zn	213.857 (I) (5.8 eV)	Cs 697.327	206.200 (II) (12.2 eV)	Sc 335.372
Mn	257.61 (II) (12.3 eV)	Sc 335.372	260.568 (II) (11 eV)	Sc 335.372
Sr	421.552 (II) (8.6 eV)	Sc 335.372	407.771 (II) (8.7 eV)	Sc 335.372
Al	396.152 (I) (3.1 eV)	Cs 697.327	167.019 (I) (7.4 eV)	Cs 697.327
Rb	780.026 (I) (1.6 eV)	Cs 697.327		

COMPENDIUM OF INTERNATIONAL ANALYSIS OF METHODS - OIV
Analysis of mineral elements in wines using ICP-AES (inductively
coupled plasma / atomic emission spectrometry)

	<i>eV</i>			
Li	670.783 (I) (1.9 <i>eV</i>)	Cs 697.327		
Ba	455.403 (II) (7.9 <i>eV</i>)	Sc 335.372		
Sc	335.372 (II) (10.3 <i>eV</i>)			
Cs	697.327 (I) (1.8 <i>eV</i>)			

8. Calculation

Calculate the concentration of the elements in the sample using the following equation:

$$C = \frac{C_m \times V_t}{V_m}$$

Where:

C: concentration of the element in the wine sample (mg/L)

C_m: concentration of the element in the diluted solution (mg/L)

V_t: volume of the dilution flask (mL) (here *V*=50 mL)

V_m: volume of the sample taken for dilution (mL) (here *V*=1 or 10 mL)

COMPENDIUM OF INTERNATIONAL ANALYSIS OF METHODS - OIV
Analysis of mineral elements in wines using ICP-AES (inductively
coupled plasma / atomic emission spectrometry)

9. Precision

Elements	Repeatability (RSD %)	Reproducibility (RSD %)	LD (mg/L)	LQ (mg/L)	Recovery rate
<u>K</u>	2.3	5.5	major	major	Between 80% and 120%
Ca	3.5	11.3	major	major	
Mg	2.4	8.9	major	major	
Na	2.6	9.1	major	major	
Fe	2.2	6.9	0.08	0.25	
Cu	13.4	15.8	0.03	0.10	
Zn	3.6	6.5	0.03	0.10	
Mn	4.7	7.0	0.03	0.10	
Al	5.6	17.0	0.03	0.10	
Sr	2.1	9.9	0.03	0.10	
Ba	8.2	20.8	0.03	0.10	

APPENDIX:

COMPENDIUM OF INTERNATIONAL ANALYSIS OF METHODS - OIV
Analysis of mineral elements in wines using ICP-AES (inductively
coupled plasma / atomic emission spectrometry)

VALIDATION STUDY – Results of the collaborative trials

A validation study was performed in November 2011 (pre-study) and in February 2012 (validation study) in accordance with ISO 5725 and resolution OENO 6/2000.

Pre-study:

3 samples (dry white wine, red wine and sweet white wine), spiked with Al, Fe, Cu, Sr, Ba, Mn and Zn.

Element (mg/L)	Samples		
	Red wine	Dry white wine	Sweet wine
K	1258	725	841
Ca	50	75	81
Na	20	28	24
Mg	78	70	66
Al	1.29	1.33	1.97
Fe	8.12	6.91	9.29
Cu	0.86	0.86	0.94
Sr	1.07	1.08	1.07
Ba	0.77	0.72	0.63
Mn	1.6	2.01	1.77
Zn	1.51	2.53	1.69

SAMPLES

COMPENDIUM OF INTERNATIONAL ANALYSIS OF METHODS - OIV
Analysis of mineral elements in wines using ICP-AES (inductively
coupled plasma / atomic emission spectrometry)

Element	White wine 1			White wine 2		
	Ref value (mg/L)	Spike (mg/L)	Recovery %	Ref value (mg/L)	Spike (mg/L)	Recovery %
K	754	0	98	1080	351	96
Ca	83	11	98	76	0	102
Na	50	28	105	24	0	100
Mg	65	0	98	72	7	102
Al	0.50	0	100	1.19	1	104
Fe	2.86	1	94	1.71	0	97
Cu	0.04	0	no add.	0.71	1	103
Sr	1.27	1	105	0.22	0	108
Ba	0.08	0	102	0.64	1	96
Mn	1.84	1	98	1.12	0	102
Zn	1.40	0	100	2.12	1	102

Element	Red wine 1			Red wine 2		
	Ref value (mg/L)	Spike (mg/L)	Recovery %	Ref value (mg/L)	Spike (mg/L)	Recovery %
K	1160	70	100	1371	316	95
Ca	62	1	103	67	7	101
Na	71	56	100	19	0	100
Mg	82	7	102	80	0	99
Al	0.81	0	105	1.82	1	103
Fe	4.90	0	101	4.55	0	101
Cu	0.46	0	102	0.12	0	65
Sr	0.28	0	102	1.32	1	105
Ba	0.12	0	102	0.62	1	97
Mn	1.81	1	100	1.10	0	101
Zn	0.95	0	107	1.68	1	101

COMPENDIUM OF INTERNATIONAL ANALYSIS OF METHODS - OIV
Analysis of mineral elements in wines using ICP-AES (inductively
coupled plasma / atomic emission spectrometry)

Element	Sweet wine 1			Sweet wine 2		
	Ref value (mg/L)	Spike (mg/L)	Recovery %	Ref value (mg/L)	Spike (mg/L)	Recovery %
K	1105	246	96	832	0	102
Ca	85	4	99	92	10	101
Na	68	42	98	21	0	100
Mg	63	0	97	66	6	101
Al	1.65	1	101	0.80	0	96
Fe	3.03	0	97	4.63	0	101
Cu	0.73	1	101	0.12	0	94
Sr	1.73	1	106	0.22	0	96
Ba	0.11	0	94	0.34	0	90
Mn	1.01	0	99	1.62	1	102
Zn	1.53	1	102	1.18	0	100

Participant laboratories had the choice to carry out the analysis of elements

- either in two steps: high dilution for major elements and low dilution for minor elements, preferably with internal standards.
- or in one step: the same dilution for all elements with internal standards.

For each sample number and for each determination, the first individual value was used. The two individual portions of blind identical replicas per laboratory are considered as a single material.

Outlier elimination was performed using a sequential application of the Cochran (applied to variances) and Grubbs (applied to mean values) tests (at a 2.5% probability (P) level, 1-tail for Cochran and 2-tail for Grubbs) until no further outliers were flagged or until a drop of 22.2% in the original number of laboratories providing valid data occurred.

With the exception of the element calcium in the "sweet wine 2" sample, which exhibits a Horrat R value of 2.2, all the elements were compliant. For this sample, 93% of the laboratories have a satisfactory Z-score (14 results) and 7% of the laboratories have a questionable Z-score (1 result). Consequently, as the five other samples were compliant for the determination of calcium, including another sweet wine sample with the same calcium concentration, it was decided to validate this element and to include it in the analytical method.

COMPENDIUM OF INTERNATIONAL ANALYSIS OF METHODS - OIV
Analysis of mineral elements in wines using ICP-AES (inductively
coupled plasma / atomic emission spectrometry)

For the determination of major elements, 9 laboratories used a high dilution and 6 laboratories used a single dilution for all (major and minor) elements. There were no differences between the results of both groups.

Tableau 1 - Potassium

Statistical parametres	White Wine 1	White Wine 2	Red wine 1	Red wine 2	Sweet wine 1	Sweet wine 1
Total	15,00	15,00	15,00	15,00	15,00	15,00
Accepted	13,00	13,00	14,00	11,00	14,00	14,00
Repetitions	2,00	2,00	2,00	2,00	2,00	2,00
Vréf (mg/L)	754,38	1079,82	1160,33	1370,96	1105,46	831,62
Limit of repeatability - r	22,45	47,32	132,68	50,64	124,78	42,92
RSD r (%)	1,10	1,50	4,00	1,30	4,00	1,80
RSD r Horwitz	3,90	3,69	3,65	3,56	3,68	3,84
r Horrat	0,30	0,40	1,10	0,40	1,10	0,50
Limite de reproductibility - R	139,25	182,82	165,46	147,56	176,10	142,93
RSD R (%)	6,50	6,00	5,00	3,80	5,60	6,10
RSD R Horwitz	5,90	5,59	5,53	5,39	5,57	5,82
R Horrat	1,10	1,10	0,90	0,70	1,00	1,00

COMPENDIUM OF INTERNATIONAL ANALYSIS OF METHODS - OIV
Analysis of mineral elements in wines using ICP-AES (inductively
coupled plasma / atomic emission spectrometry)

Tableau 2 - Calcium

Statistical parametres	White Wine 1	White Wine 2	Red wine 1	Red wine 2	Sweet wine 1	Sweet wine 1
Total	15,00	15,00	15,00	15,00	15,00	15,00
Accepted	10,00	10,00	13,00	10,00	13,00	15,00
Repetitions	2,00	2,00	2,00	2,00	2,00	2,00
Vréf (mg/L)	85,37	73,43	67,68	66,00	78,35	92,39
Limit of repeatability - r	3,30	4,12	4,60	2,86	7,96	26,66
RSD r (%)	2,10	2,00	2,40	1,50	3,60	10,20
RSD r Horwitz	5,85	5,53	5,60	5,62	5,48	5,34
r Horrat	0,30	0,40	0,40	0,30	0,70	1,90
Limite de reproductibility - R	10,68	10,45	42,58	9,51	29,85	45,60
RSD R (%)	4,40	5,00	22,20	5,10	13,50	17,40
RSD R Horwitz	8,19	8,38	8,48	8,52	8,30	8,10
R Horrat	0,50	0,60	2,60	0,60	0,60	2,20

COMPENDIUM OF INTERNATIONAL ANALYSIS OF METHODS - OIV
Analysis of mineral elements in wines using ICP-AES (inductively
coupled plasma / atomic emission spectrometry)

Tableau 3 - Sodium

Statistical parametres	White Wine 1	White Wine 2	Red wine 1	Red wine 2	Sweet wine 1	Sweet wine 1
Total	15,00	15,00	15,00	15,00	15,00	15,00
Accepted	15,00	13,00	12,00	12,00	14,00	15,00
Repetitions	2,00	2,00	2,00	2,00	2,00	2,00
Vréf (mg/L)	50,50	24,09	71,43	18,76	67,91	21,42
Limit of repeatability - r	3,00	1,32	2,53	1,73	5,20	1,85
RSD r (%)	2,10	1,90	1,20	3,30	2,70	3,00
RSD r Horwitz	5,85	6,54	5,55	6,79	5,60	6,6
r Horrat	0,30	0,30	0,20	0,50	0,50	0,50
Limite de reproductibility - R	9,41	6,09	15,19	6,72	13,09	6,49
RSD R (%)	6,60	9,90	7,50	12,70	6,80	10,70
RSD R Horwitz	8,87	9,91	8,42	10,29	8,48	10,09
R Horrat	0,70	0,90	0,90	1,20	0,80	1,10

COMPENDIUM OF INTERNATIONAL ANALYSIS OF METHODS - OIV
Analysis of mineral elements in wines using ICP-AES (inductively
coupled plasma / atomic emission spectrometry)

Tableau 4 - Magnésium

Statistical parametres	White Wine 1	White Wine 2	Red wine 1	Red wine 2	Sweet wine 1	Sweet wine 1
Total	15,00	15,00	15,00	15,00	15,00	15,00
Accepted	15,00	15,00	14,00	14,00	13,00	14,00
Repetitions	2,00	2,00	2,00	2,00	2,00	2,00
Vréf (mg/L)	65,30	72,03	82,15	80,01	62,63	65,53
Limit of repeatability - r	3,43	4,29	10,27	7,25	5,32	2,27
RSD r (%)	1,90	2,10	4,40	3,20	3,00	1,20
RSD r Horwitz	5,63	5,55	5,44	5,46	5,67	5,63
r Horrat	0,30	0,40	0,80	0,60	0,50	0,20
Limite de reproductibility - R	15,26	16,33	29,80	20,23	15,86	13,74
RSD R (%)	8,30	8,00	12,80	8,90	8,90	7,40
RSD R Horwitz	8,53	8,40	8,24	8,27	8,58	8,53
R Horrat	1,00	1,00	1,60	1,10	1,00	0,90

COMPENDIUM OF INTERNATIONAL ANALYSIS OF METHODS - OIV
Analysis of mineral elements in wines using ICP-AES (inductively
coupled plasma / atomic emission spectrometry)

Tableau 5 - Aluminium

Statistical parametres	White Wine 1	White Wine 2	Red wine 1	Red wine 2	Sweet wine 1	Sweet wine 1
Total	15,00	15,00	15,00	15,00	15,00	15,00
Accepted	10,00	9,00	8,00	8,00	9,00	8,00
Repetitions	2,00	2,00	2,00	2,00	2,00	2,00
Vréf (mg/L)	0,50	1,19	0,81	1,82	1,65	0,80
Limit of repeatability - r	0,19	0,11	0,22	0,15	0,15	0,05
RSD r (%)	13,10	3,30	9,40	2,80	3,20	2,10
RSD r Horwitz	11,71	10,29	10,89	9,65	9,79	10,93
r Horrat	1,10	0,30	0,90	0,30	0,30	0,20
Limite de reproductibility - R	0,42	0,33	0,33	0,46	0,97	0,41
RSD R (%)	29,80	10,00	14,20	8,90	20,80	18,10
RSD R Horwitz	17,75	15,59	16,50	14,61	14,84	16,56
R Horrat	1,70	0,60	0,90	0,60	1,40	1,10

COMPENDIUM OF INTERNATIONAL ANALYSIS OF METHODS - OIV
Analysis of mineral elements in wines using ICP-AES (inductively
coupled plasma / atomic emission spectrometry)

Tableau 6 - Fer

Statistical parametres	White Wine 1	White Wine 2	Red wine 1	Red wine 2	Sweet wine 1	Sweet wine 1
Total	10,00	10,00	10,00	10,00	10,00	10,00
Accepted	6,00	7,00	7,00	6,00	7,00	7,00
Repetitions	2,00	2,00	2,00	2,00	2,00	2,00
Vréf (mg/L)	2,86	1,71	4,90	4,55	3,03	4,63
Limit of repeatability - r	0,19	0,06	0,57	0,33	0,21	0,70
RSD r (%)	2,30	1,30	4,10	2,60	2,40	0,50
RSD r Horwitz	9,02	9,74	8,31	8,41	8,94	8,38
r Horrat	0,30	0,10	0,50	0,30	0,30	0,10
Limite de reproductibility - R	0,20	0,29	0,99	0,34	0,34	2,52
RSD R (%)	2,50	6,10	7,10	2,60	3,90	19,20
RSD R Horwitz	13,66	14,76	12,59	12,74	13,54	12,70
R Horrat	0,20	0,40	0,60	0,20	0,30	1,50

COMPENDIUM OF INTERNATIONAL ANALYSIS OF METHODS - OIV
Analysis of mineral elements in wines using ICP-AES (inductively
coupled plasma / atomic emission spectrometry)

Tableau 7 - Cuivre

Statistical parametres	White Wine 1	White Wine 2	Red wine 1	Red wine 2	Sweet wine 1	Sweet wine 1
Total	9,00	10,00	10,00	10,00	10,00	10,00
Accepted	7,00	10,00	8,00	10,00	8,00	10,00
Repetitions	2,00	2,00	2,00	2,00	2,00	2,00
Vréf (mg/L)	0,04	0,71	0,46	0,12	0,73	0,12
Limit of repeatability - r	0,03	0,10	0,08	0,05	0,03	0,10
RSD r (%)	24,30	4,80	6,00	14,40	1,70	29,00
RSD r Horwitz	16,95	11,12	11,87	14,62	11,07	14,55
r Horrat	1,40	0,40	0,50	1,00	0,20	2,00
Limite de reproductibility - R	0,03	0,21	0,09	0,05	0,14	0,10
RSD R (%)	24,30	10,40	6,80	16,40	6,80	30,10
RSD R Horwitz	25,68	16,84	17,98	22,15	16,77	22,05
R Horrat	0,90	0,60	0,40	0,70	0,40	1,40

COMPENDIUM OF INTERNATIONAL ANALYSIS OF METHODS - OIV
Analysis of mineral elements in wines using ICP-AES (inductively
coupled plasma / atomic emission spectrometry)

Tableau 8 – Strontium

Statistical parametres	White Wine 1	White Wine 2	Red wine 1	Red wine 2	Sweet wine 1	Sweet wine 1
Total	8,00	8,00	8,00	8,00	8,00	8,00
Accepted	7,00	7,00	7,00	6,00	7,00	6,00
Repetitions	2,00	2,00	2,00	2,00	2,00	2,00
Vréf (mg/L)	1,27	0,22	0,28	1,32	1,73	0,22
Limit of repeatability - r	0,03	0,01	0,04	0,06	0,12	0,00
RSD r (%)	1,00	1,70	5,50	1,70	2,60	0,50
RSD r Horwitz	10,19	13,25	12,76	10,13	9,72	13,30
r Horrat	0,01	0,10	0,40	0,20	0,30	0,00
Limite de reproductibility - R	0,18	0,07	0,12	0,09	0,24	0,12
RSD R (%)	5,10	11,40	15,30	2,50	5,00	20,00
RSD R Horwitz	15,44	20,08	19,34	15,34	14,73	22,15
R Horrat	0,30	0,60	0,80	0,20	0,30	1,00

COMPENDIUM OF INTERNATIONAL ANALYSIS OF METHODS - OIV
Analysis of mineral elements in wines using ICP-AES (inductively
coupled plasma / atomic emission spectrometry)

Tableau 9 - Barium

Statistical parametres	White Wine 1	White Wine 2	Red wine 1	Red wine 2	Sweet wine 1	Sweet wine 1
Total	8,00	8,00	8,00	8,00	8,00	8,00
Accepted	7,00	8,00	8,00	7,00	8,00	8,00
Repetitions	2,00	2,00	2,00	2,00	2,00	2,00
Vréf (mg/L)	0,08	0,64	0,12	0,62	0,11	0,34
Limit of repeatability - r	0,01	0,38	0,01	0,16	0,01	0,06
RSD r (%)	5,70	21,00	3,60	9,20	3,30	6,30
RSD r Horwitz	15,33	11,30	14,52	11,34	14,73	12,41
r Horrat	0,40	1,90	0,20	0,80	0,20	0,50
Limite de reproductibility - R	0,04	0,38	0,05	0,54	0,05	0,24
RSD R (%)	18,80	21,00	13,90	30,07	15,80	24,50
RSD R Horwitz	23,23	17,12	22,00	17,18	22,32	18,80
R Horrat	0,80	1,20	0,60	1,80	0,70	1,30

COMPENDIUM OF INTERNATIONAL ANALYSIS OF METHODS - OIV
Analysis of mineral elements in wines using ICP-AES (inductively
coupled plasma / atomic emission spectrometry)

Tableau 10 - Manganèse

Statistical parametres	White Wine 1	White Wine 2	Red wine 1	Red wine 2	Sweet wine 1	Sweet wine 1
Total	10,00	10,00	10,00	10,00	10,00	10,00
Accepted	9,00	10,00	9,00	10,00	8,00	8,00
Repetitions	2,00	2,00	2,00	2,00	2,00	2,00
Vréf (mg/L)	1,84	1,12	1,81	1,10	0,11	1,62
Limit of repeatability - r	0,09	0,21	0,49	0,14	0,13	0,60
RSD r (%)	1,60	6,50	9,60	4,50	4,60	1,30
RSD r Horwitz	9,64	10,38	9,66	10,41	10,55	9,82
r Horrat	0,20	0,60	1,00	0,40	0,40	0,10
Limite de reproductibility - R	0,25	0,21	0,49	0,22	0,22	0,38
RSD R (%)	4,80	6,50	9,60	7,10	7,10	8,30
RSD R Horwitz	14,60	15,73	14,63	15,78	15,98	14,88
R Horrat	0,30	0,40	0,70	0,50	0,30	0,60

COMPENDIUM OF INTERNATIONAL ANALYSIS OF METHODS - OIV
Analysis of mineral elements in wines using ICP-AES (inductively
coupled plasma / atomic emission spectrometry)

Tableau 11 - Zinc

Statistical parametres	White Wine 1	White Wine 2	Red wine 1	Red wine 2	Sweet wine 1	Sweet wine 1
Total	10,00	10,00	10,00	10,00	10,00	10,00
Accepted	7,00	8,00	9,00	8,00	7,00	7,00
Repetitions	2,00	2,00	2,00	2,00	2,00	2,00
Vréf (mg/L)	1,40	2,12	0,95	1,68	1,53	1,18
Limit of repeatability - r	0,09	0,16	0,22	0,10	0,18	0,05
RSD r (%)	2,40	2,60	8,40	2,20	4,20	1,60
RSD r Horwitz	10,03	9,43	10,65	9,77	9,91	10,30
r Horrat	0,20	0,30	0,80	0,20	0,40	0,20
Limite de reproductibility - R	0,10	0,39	0,29	0,36	0,22	0,22
RSD R (%)	2,40	6,50	10,70	7,60	5,10	6,70
RSD R Horwitz	15,20	14,28	16,13	14,80	15,01	15,61
R Horrat	0,20	0,50	0,70	0,50	0,30	0,40

**COMPENDIUM OF INTERNATIONAL ANALYSIS OF METHODS - OIV
Analysis of mineral elements in wines using ICP-AES (inductively
coupled plasma / atomic emission spectrometry)**

2/ Laboratoires participants :

Onze laboratoires ont participé à cette étude collaborative :

- State General Laboratory, NMR Lab, Nicosia Chypre
- ANALAB CHILE S.A., Santiago Chile
- CISTA, National Reference Laboratory Brno Czech Republic
- Laboratório de Análises- REQUIMTE- FCT/UNL, Caparica Portugal
- Laboratório Central de Análises - Universidade de Aveiro Portugal
- Laboratory of National Center of Alcoholic Beverages Testing, Chisinau Republic of Moldova
- National Research Institute of Brewing, Higashiroshima Japon
- Instituto Nacional de Vitivinicultura, Laboratorio General, Mendoza Argentine
- LFZ Wein und Obstbau, Klosterneuburg Autriche
- Laboratorio Arbitral Agroalimentario, Madrid Spain
- Laboratoire SCL de Bordeaux-Pessac France

Method OIV-MA-AS323-01A

Type IV method

**Determination of arsenic in wine
by atomic absorption spectrometre**
(Resolution Oeno 14/2002)

1. PRINCIPLE

After evaporating ethyl alcohol and reducing the arsenic V in arsenic III, wine arsenic is measured by hydride generation and by atomic absorption spectrometry.

2. EQUIPMENT

2.1. Glass ware:

- 2.1.1. Graduated flask 50, 100 ml (class A)
- 2.1.2. Graduated pipettes 1, 5, 10, 25 ml (class A)

2.2. Water bath at 100°C

2.3. Filters without ashes

2.4. Spectrophotometer :

- 2.4.1. Atomic absorption spectrophotometer
- 2.4.2. Instrumental parameters
 - 2.4.2.1. Air-acetylene oxidising flame
 - 2.4.2.2. Hollow cathode lamp (arsenic)
 - 2.4.2.3. Wave length: 193.7 nm
 - 2.4.2.4. Split width: 1.0 nm
 - 2.4.2.5. Intensity of hollow cathode lamp: 7 mA
 - 2.4.2.6. Correction of non-specified absorption with a deuterium lamp

2.5. Accessories:

- 2.5.1. Hydride absorption cell, placed on an air-acetylene burner.
- 2.5.2. Vapour generator (liquid gas separator)
- 2.5.3. Neutral gas (argon)

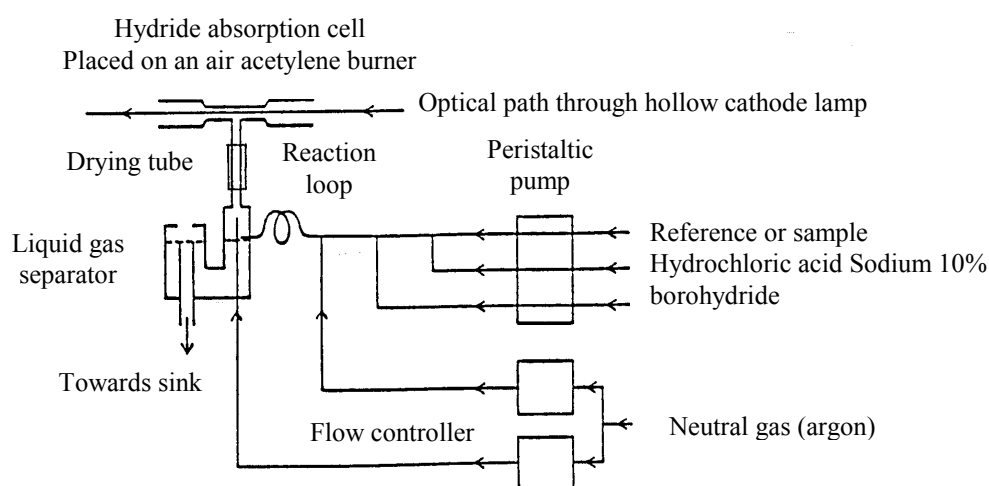

Figure 1. Hydride generator.

3. REAGENTS

3.1. Ultra-pure demineralised water

3.2. Ultra-pure 65% nitric acid

3.3. Potassium iodide (KI)

3.4. 10% . Potassium iodide (m/v)

3.5. Concentrated hydrochloric acid (R)

3.6. 10% Hydrochloric acid (R)

3.7. Sodium borohydride (NaBH₄)

3.8. Sodium hydroxide (NaOH)

3.9. 0.6% Sodium borohydride (containing sodium hydroxide: 0.5% (m/v))

3.10. Calcium Chloride CaCl₂ (used as a drying agent)

3.11. 1 g/l Arsenic stock solution prepared in the following manner :
dissolve 1.5339 g of AS₂O₅ in demineralised water, adjust to 1 l.

3.12. 10 mg/l Arsenic solution: place 1 ml of stock solution (3.11.) in a 100 ml flask (2.1.1.) ; add 1 % nitric acid (3.2.) ; fill up to volume with demineralised water (3.1.).

3.13. 100 µg/l Arsenic solution: place 1 ml of 10 mg/l arsenic solution (3.12.) in a 100 ml flask (2.1.1.) ; fill up to volume with demineralised water (3.1.).

3.14. Set of calibration standards: 0, 5, 10, 25 µg/l
Successively place 0, 5, 10, 25 ml of 100 µg/l arsenic solution (3.13.) in 4 100 ml flasks (2.1.1.) ; add 10 ml of 10% potassium iodide to each flask (3.4.) and 10 ml of concentrated hydrochloric acid (3.5.) ; leave for 1 hour, fill up to 100 ml with demineralised water.

4. SAMPLE PREPARATION

25 ml of water is evaporated over a 100 °C water bath. This is then brought to 50 ml in the presence of 5 ml of 10% potassium iodide and 5 ml of concentrated hydrochloric acid; leave for 1 hour; filter on an ashless filter.

Make a blank reference sample.

5. DETERMINATION

The peristaltic pump sucks in the borohydride solution, the 10% hydrochloric acid solution and the sample solution.

Present the calibration standards in succession (3.14.); take an absorbency reading for 10 seconds; take two readings; the operating software establishes a calibration curve (absorbency according to concentration of arsenic in µg/l).

Then present the samples (4) ; the software establishes the sample's arsenic concentration in µg/l; deduct the arsenic concentration in the wine in µg/l taking into account that the solution be diluted by 1 / 2 .

6. QUALITY CONTROL

Quality control is assured by placing a control sample of internal quality (*) in a regular manner in 5 samples, or after the set of calibration solutions, or in the middle of a series or at the end the measurement.

Two deviation types are accepted compared to known value.

(*) Samples from the Bureau Communautaire de Référence (Community Bureau of reference): red wine, dry white wine and sweet white wine.

7. BIBLIOGRAPHY

Varian Techtron, 1972. Analytical methods for flame spectroscopy.

Hobbins B., 1982. Arsenic Determination by Hydride Generation. Varian Instruments at Work.

Le Houillier R., 1986. Use of Drierite Trap to Extend the Lifetime of Vapor Generation Absorption Cell. Varian Instruments at Work.

Varian, 1994. Vapor Generation Accessory VGA-77.

Arsenic
(Resolution Oeno 377/2009)

1. Principle

After mineralization, using sulfuric and nitric acids, arsenic V is reduced to arsenic III by means of potassium iodide in hydrochloric acid and the arsenic is transformed into arsenic III hydride (H_3As) using sodium borohydride. The arsenic III hydride formed is carried by nitrogen gas and determined by flameless atomic absorption spectrophotometry at high temperature.

2. Method

2.1 *Apparatus*

2.1.1 Kjeldahl flask (borosilicate glass)

2.1.2 Atomic absorption spectrophotometer equipped with arsenic hollow cathode lamp, hydride generator, background corrector and a chart recorder.

The hydride generator includes a reaction flask (which can eventually be put onto a magnetic stirrer) connected by a tube to a nitrogen gas supply (flow rate: 11 L/min) and by a second tube, to a quartz cell which can be brought to a temperature of 900 °C. The reaction flask also has an opening for the introduction of the reagent (borohydride).

2.2 *Reagents*

All reagents must be of recognized analytically pure quality, and in particular free of arsenic. Double distilled water prepared using a borosilicate glass flask or water of similar purity should be used.

2.2.1 Sulfuric acid ($\rho_{20} = 1.84$ g/mL) arsenic free

2.2.2 Nitric acid ($\rho_{20} = 1.38$ g/mL) arsenic free

2.2.3 Hydrochloric acid ($\rho_{20} = 1.19$ g/mL), arsenic free

2.2.4 10% (*m/v*) Potassium iodide solution

2.2.5 2.5% (*m/v*) Sodium borohydride solution obtained by dissolving 2.5 g of sodium borohydride in 100 mL of 4 % (*m/v*) of sodium hydroxide solution. This solution must be prepared at the time of use.

2.2.6 Arsenic reference solution 1 g/L. Use of a commercial standard arsenic solution is preferred.

Alternatively this solution can be prepared in a 1000 mL volumetric flask, by dissolving 1.320 g of arsenic III trioxide As_2O_3 in a minimal volume of 20 % (m/v) sodium hydroxide. The solution is then acidified with hydrochloric acid, diluted 1/2, and made up to 1 liter with water.

2.3 Procedure

2.3.1 Mineralization

Place 20 mL of wine in a Kjeldahl flask, boil and reduce the volume by half to eliminate alcohol. Allow to cool. Add 5 mL sulfuric acid, and slowly add 5 mL nitric acid and heat. As soon as the liquid turns brown, add just enough nitric acid, dropwise, to lighten the liquid while simmering. Continue until the color clears and white sulfur trioxide fumes are formed above the solution.

Allow to cool, add 10 mL distilled water, bring back to the boil and simmer until nitrous oxide and sulfur trioxide fumes are no longer produced. Allow to cool and repeat the operation.

Allow to cool and dilute the sulfuric acid residue with a few milliliters of distilled water. Quantitatively transfer the solution into a 40 mL flask, and rinse the flask with water, combine with the diluted residue and make up to the mark with distilled water.

2.3.2 Determination

2.3.2.1 Preparation of the solution

Place 10 mL of the mineralization solution (2.3.1) into the hydride generator reactor flask. Add 10 mL hydrochloric acid, 1.5 mL potassium iodide solution, then switch on the magnetic stirrer and the nitrogen gas (flow rate: 11 L/minute). After 10 sec, add 5 mL of sodium borohydride solution. The hydride vapor obtained is immediately carried to the measurement cell (at a temperature of 900°C) by nitrogen carrier gas, where dissociation of the compound and arsenic atomization occurs.

2.3.2.2 Preparation of standard solutions

From the arsenic reference solution (2.2.6), prepare dilutions having concentrations of 1, 2, 3, 4 and 5 micrograms of arsenic per liter respectively. Place 10 mL of each of the prepared solutions into the reactor flask of the hydride generator and analyze according to 2.3.2.1.

2.3.2.3 Measurements

Select an absorption wavelength of 193.7 nm. Zero the spectrophotometer using double distilled water and carry out all determinations in duplicate. Record the absorbance of each sample and standard solution. Calculate the average absorbance for each of these solutions.

2.4 Expression of results

2.4.1 Calculation

Plot the curve showing the variation in absorbance as a function of the arsenic concentration in the standard solutions. The relationship is linear. Note the average absorbance of the sample solutions on the graph and read the arsenic concentration C.

The arsenic concentration in wine, expressed in micrograms per liter is given by: $2 C$.

BIBLIOGRAPHY

JAULMES P. et HAMELLE G., *Trav. Soc. Pharm. Montpellier*, 1967, **27**, n° 3, 213-225.

JAULMES P., *F.V., O.I.V.*, 1967, n° 238

MEDINA B et SUDRAUD P., *F.V., O.I.V.*, 1983, n° 770.

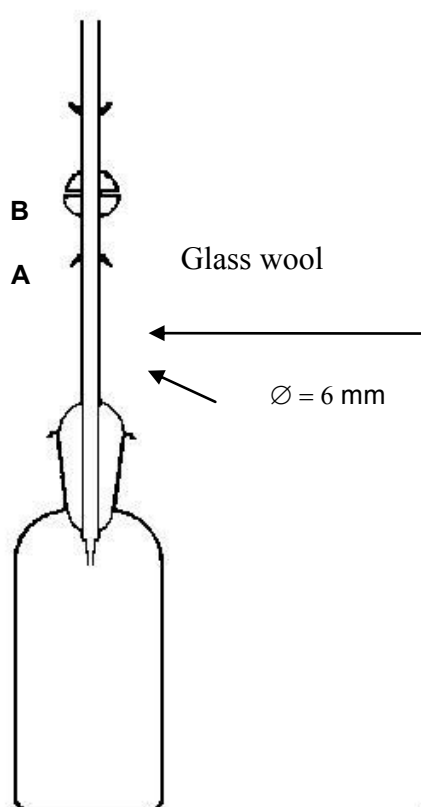

Fig.1: Apparatus used in the limit test of arsenic

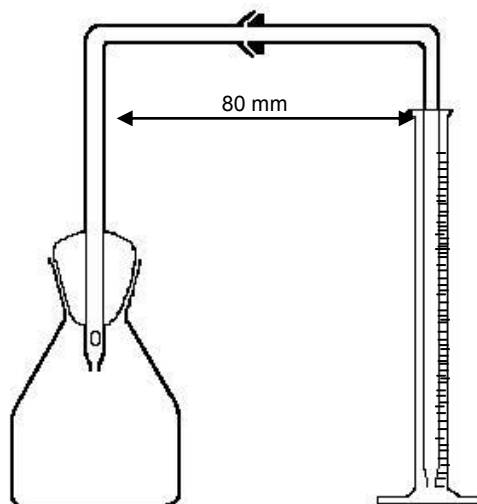

Fig 2: Apparatus used in the determination of arsenic

Method OIV-MA-AS323-01C

Arsenic
(Resolution Oeno 377/2009)

1. Principle

After mineralization using sulfuric and nitric acids, arsenic V is reduced to arsenic III using tin II chloride. The arsenic is then converted into arsenic III hydride by the action of the hydrogen produced. Arsenic III hydride is detected by reaction with mercury II bromide (limit sample).

WITHDRAWN

**Quantification of total nitrogen according
to the Dumas method**
(Musts and Wines)
(Resolution Oeno 13/2002)

1 - FIELD OF APPLICATION

This method can be applied to the analysis of total nitrogen in musts and wine within the range of 0 to 1000 mg/l.

2 - DESCRIPTION OF THE TECHNIQUE

2.1 - Principle of the Dumas method

The analysis of total nitrogen in an organic matrix can be carried out using the Dumas method (1831). This involves a total combustion of the matrix under oxygen. The gases produced are reduced by copper and then dried, while the CO₂ is trapped. The nitrogen is then quantified using a universal detector.

2.2 - Principle of the analysis (Figure n° 1)

- Injection of the sample and oxygen in the combustion tube at 940°C (1) ;
- « Flash » Combustion (2) ;
- The combustion of the gathering ring (3) brings the temperature temporarily up to 1800°C ;
- Complementary oxidation and halogen trappings on silver cobalt and granular chromium sesquioxide (4) ;
- Reduction of nitrogen oxides in N₂ and trapping sulphur components and excess oxygen by copper at 700°C (5) ;
- Gases in helium include: N₂, CO₂ and H₂O (6) ;
- Trapping unmeasured elements: H₂O using anhydron (granular anhydrous magnesium perchlorate) (7) and CO₂ by ascarite (sodium hydroxide on silica) (8) ;
- Chromatography separation of nitrogen and methane possibly present following very large trial uptake (9) ;
- Catharometer detection (10) ;
- Signal gathering and data processing (11).

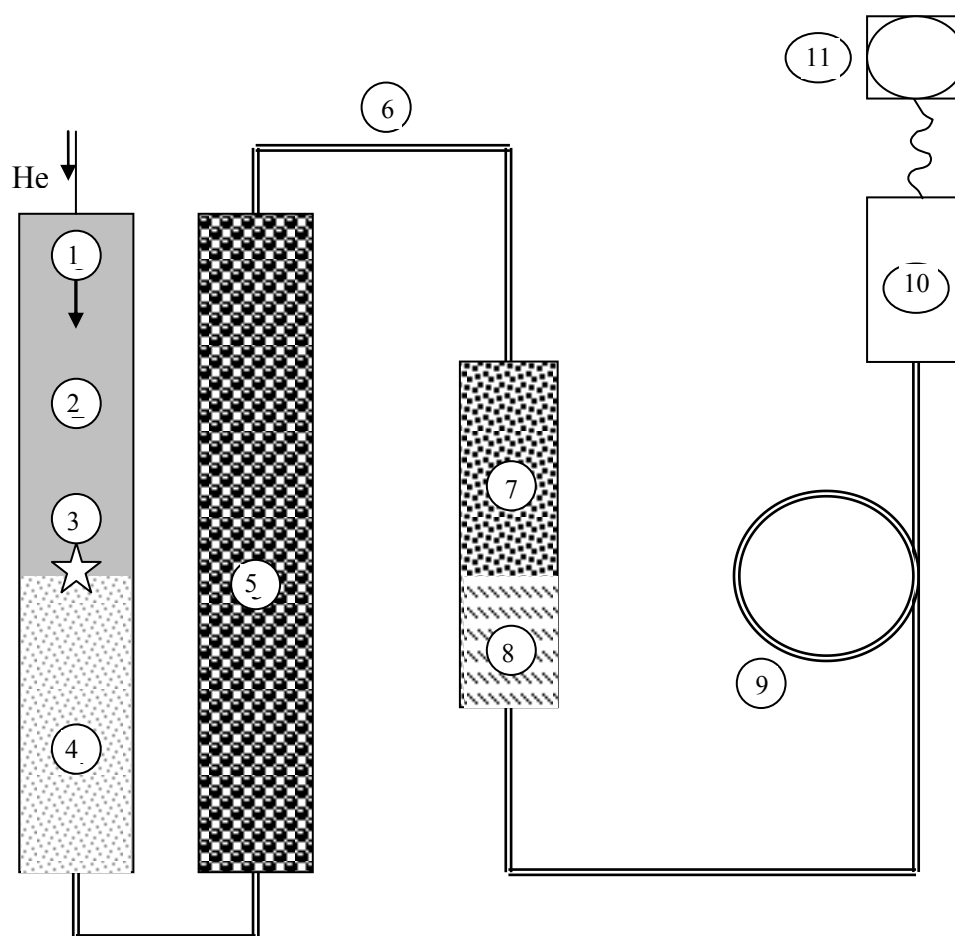

Figure 1 : Diagram of analysis principle

3 – Reagents and preparation of reactive solutions

3.1 - Nitrogen (technical quality) ;

3.2 - Helium (purity 99.99994%) ;

3.3 – Chromium oxide (chromium sesquioxide me in granules) ;

- 3.4 – **Cobalt Oxide** (silver granule cobalto-cobaltic oxide) ;
- 3.5 – **Quartz wool** ;
- 3.6 - **Copper** (reduced copper in strings) ;
- 3.7 - **Ascarite** (sodium hydroxide on silica) ;
- 3.8 - **Anhydron** (granular anhydrous magnesium perchlorate) ;
- 3.9 - **Oxygen** (purity 99.995%) ;
- 3.10 - **Atropine** ;
- 3.11 – **Glumatic-hydric chloride acid**;
- 3.12 – **Demineralised water**;
- 3.13 – **Tin boat**.

4 - Apparatus

- 4.1 - **Centrifuge** with 25 ml pots;
- 4.2 – **Nitrogen analyser**;
- 4.3 – **Metallic crucible**;
- 4.4 - **Quartz reaction tube** (2) ;
- 4.5 – **Precision balance** between 0.5 mg and 30 g at ± 0.3 mg ;
- 4.6 – **Boat carrier**;
- 4.7.- **Furnace**;
- 4.8 – **Apparatus for folding boats**;
- 4.9 – **Sample changer**;
- 4.10 – **Computer and printer**.

5 - SAMPLING

Degas by nitrogen bubbling (3.1) for 5 to 10 mn, sparkling wine. The musts are centrifuged (4.1) for 10 mn at 10°C, at 4200 g.

6 – OPERATING INSTRUCTIONS

- Open the apparatus programme (4.2 and 4.10) ;
- Put the heating on the apparatus (4.2).

6.1 – Principle analytical parameters

Nitrogen analyser (4.2) under the following conditions:

- gas carrier: helium (3.2) ;
- metallic crucible (4.3) to be emptied every 80 analyses ;

- oxidation tube (4.4), heated to 940° C, containing chromium oxide (3.3) and cobalt oxide(3.4) held back by quartz wool (3.5). The tube and reagent set must be changed every 4000 analyses ;
 - reduction tube (4.4), heated to 700° C, containing copper (3.6) held back by the quartz wool (3.5). The copper is changed every 450 analyses;
 - absorption tube, containing 2/3 of ascarite (3.7) and 1/3 anhydrone (3.8). the ascarite which is taken in block is eliminated and replaced every 200 analyses. The absorbers are completely changed once a year.
 - The more organic matter to be burned, the more oxygen is needed: the oxygen sampling valve (3.9) is 15 seconds for musts and 5 seconds for wine.

NOTE : The metals are recuperated and sent to a centre for destruction or specialised recycling.

6.2 - Preparation of standard scale

Prepare two samples of atropine (3.10) between 4 to 6 mg. Weigh them (4.5) directly with the boat. The calibration scale goes through 3 points (origin = empty boat).

6.3 – Preparation of internal standards

Internal standards are used regularly in the beginning and in the middle of analyses.

- Internal checks are carried out using glutamic acid in the form of hydrochloride at 600 mg N/l in demineralised water (3.12).

Molar mass of glutamic acid = 183.59

Molar mass of nitrogen = 14.007

$$\frac{183.59 \times 0.6}{14.007} = 7.864 \text{ g/l}$$

- Weigh (4.5) 7.864 g of glutamic acid (3.11) and dilute in demineralised water (3.12) qsp/l, to obtain a 600 mg N/l solution. This solution is diluted by 50% to obtain a 300 mg N/l solution, which is diluted by 50% again to obtain 150 mg/l solution.

6.4 - Preparation of samples:

- 6.4.1 – In a boat (3.13), weigh (to the nearest 0.01 mg) 20 µl of must or 200 µl of wine with a precision balance (4.5). Repeat this procedure three times per sample;
- 6.4.2 – Write down the mass
- 6.4.3 – Place the boats progressively in the boat carrier (4.6) ;
- 6.4.4 – Place the boats in the furnace (4.7) set at $\simeq 60^{\circ}$ C, until the liquid has completely evaporated (this requires at least one hour) ;
- 6.4.5 – Fold and crush the boats with an appropriate apparatus (4.8), put them in the changer (4.9) in number order.

7 - EXPRESSION OF RESULTS

Results are expressed in g/l to the fourth decimal.

8 – CHECKING RESULTS

Splicing by mass, temperature, and volume.

9- PERFORMANCE CHARACTERISTICS OF THE METHOD

Number of laboratories	Average contents	Repeatability	Reproductibility
11	591 mg/l	43 mg/l	43 mg/l

10 - BIBLIOGRAPHY

Dumas A. (1826) : Annales de chimie, 33,342.

Buckee G.K. (1994) : Determination of total nitrogen in Barley, Malt and Beer by Kjeldahl procedures and the Dumas combustion method. Collaborative trial. J. Inst. Brew., 100, 57-64.

Method OIV-MA-AS323-02B

Type IV method

Total Nitrogen
(Resolution Oeno 377/2009)

1. Principle

The sample is wet ashed using sulfuric acid in the presence of a catalyst. The ammonia liberated by sodium hydroxide is determined titrimetrically.

2. Apparatus

2.1 *Digestion apparatus*

300 mL Kjeldahl flask. Place on a metal heating mantle. Appropriate stand to hold this apparatus, the neck bent at 45 degrees.

2.2 *Distillation apparatus*

1 liter round bottomed flask, fitted with a small rectifying column 30 cm long by 2.5 cm diameter or any other equivalent apparatus. The vapor emitted from the end of this apparatus enters into the top part of the cylindrical condenser, held vertically, of 30 cm length and 1 cm internal diameter. The condensed liquid is brought to the receiving conical flask by a drawn-out tube placed at the bottom – alternatively one can use a steam distillation apparatus such as described in *Volatile Acidity*, or any other apparatus relating to the test described in paragraph "*Blank tests or sample tests*".

3. Reagents

3.1 Sulfuric acid free of ammonia ($\rho_{20} = 1.83 - 1.84\text{g/mL}$)

3.2 Benzoic acid

3.3 Catalyst:

Copper sulfate, CuSO_4 ,	10 g
Potassium sulfate, K_2SO_4 ,	100 g

3.4 30% Sodium hydroxide solution. Sodium hydroxide ($\rho_{20} = 1.33\text{ g/mL}$) diluted 30% (*m/m*).

3.5 0.1 M Hydrochloric acid solution

3.6 Indicator:

Methyl red	100 mg
Methylene blue	50 mg
Ethanol (50%)	100 mL

3.7 Boric acid solution:

COMPENDIUM OF INTERNATIONAL METHODS OF ANALYSIS - OIV
Total nitrogen

Boric acid	40 g
Water to	1000 mL

This solution will become pink by adding 5 drops of methyl red and 0.1 mL or more 0.1 M hydrochloric acid solution.

3.8 Ammonium sulfate solution:

Ammonium sulfate (NH ₄) ₂ SO ₄	6.608 g
Water to	1000 mL

3.9 Tryptophan, C₁₁H₁₂O₂N₂, (this substance contains in theory 13.72 g of nitrogen per 100 g)

4. Procedure

Place in the 300 mL Kjeldahl flask (2.1), 25 mL of wine, 2 g benzoic acid (3.2) and 10 mL sulfuric acid (3.1). Add 2 to 3 g of catalyst. With the flask placed on a metal disc mantle (2.1) and with the neck inclined at 45 degrees, heat until a clear color is obtained. Then heat for another 3 minutes.

After cooling, carefully transfer the contents of the Kjeldahl flask to a 1 liter round bottomed flask containing 30 mL water. Rinse the Kjeldahl flask several times with water and add washings to the round-bottomed flask. Cool the flask; add 1 drop of 1% phenolphthalein solution and a sufficient quantity of 30% sodium hydroxide solution (3.4) to ensure the solution is alkaline (40 mL approximately) making sure to cool the flask constantly during this addition. Distil 200 - 250 mL into a flask containing 30 mL of 40 g/L boric acid solution.

Titrate the distilled ammonia in the presence of 5 drops of indicator (3.6) using 0.1 M hydrochloric acid solution.

Note: A control trainer by vapor can be used as described in the Chapter on volatile acidity to obtain a quick ammonia distillation. In this case, successively place 40 to 45 ml of 30% sodium hydroxide liquor and 50 to 60 ml of previously diluted for 10 minutes contents of the Kjeldahl flask before introducing into the mixer.

5. Calculation

The total nitrogen, in g/L, contained in the wine is given by: $0.56 \times n$ where n is the volume of 0.1 M hydrochloric acid.

6. Blank tests and sample tests

All distillation apparatus used to determine ammonia must satisfy the following tests:

- a) Place in a distillation flask 40 - 45 mL of sodium hydroxide solution, 50 mL water, 2 g benzoic acid, 5 g potassium sulfate and 10 mL sulfuric acid diluted to 50 mL. Distil 200 mL and collect the distillate in 30 mL of 40 g/L boric acid solution, to which 5 drops of indicator (3.6) are added. A change of color of

COMPENDIUM OF INTERNATIONAL METHODS OF ANALYSIS - OIV
Total nitrogen

the indicator must be obtained by adding 0.1 mL of 0.1 M hydrochloric acid solution.

- b) Under similar conditions distill 10 mL of 0.1 M ammonium sulfate solution. In this case, between 10.0 and 10.1 mL of 0.1 M hydrochloric acid solution, must be used to change the color of the indicator.
- c) The complete method (wet ashing and distillation) is checked using 200 mg tryptophan as the initial sample. Between 19.5 to 19.7 mL of 0.1 M hydrochloric acid must be used to obtain the change of color.

Boron

Rapid Colorimetric Method

1. Principle

The alcohol content of the wine is removed by reducing the volume by half by rotary evaporation. The wine is then passed through a column of polyvinylpyrrolidone, which retains the coloring agents. The eluate is collected quantitatively and the boron concentration determined by complexation with azomethine H at pH 5.2 followed by spectroscopic analysis at 420 nm.

2. Apparatus

- 2.1. Rotary evaporator
- 2.2. Spectrophotometer capable of measuring absorbance wavelengths between 300 and 700 nm
- 2.3. Cells of 1 cm optical path
- 2.4. Glass column of 1 cm internal diameter and 15 cm in length containing an 8 cm layer of polyvinylpyrrolidone.

3. Reagents

- 3.1. Azomethin H (4-hydroxy-5-(2-hydroxybenzylideneamino)-2,7-naphthalenedisulfonic acid)
- 3.2. Azomethin H solution
Place 1 g of azomethin H and 2 g of ascorbic acid in a 100 mL volumetric flask and add 50 mL double distilled water. Warm slightly to dissolve and make up to the mark with double distilled water. The reagent is stable for 2 days if kept cold.
- 3.3. Buffer solution pH 5.2
Dissolve 3g of EDTA (disodium salt of ethylenediaminetetraacetic acid) in 150 mL of double distilled water. Add 125 mL acetic acid ($\rho_{20} = 1.05 \text{ g/mL}$) and 250 g of ammonium acetate, $\text{NH}_4\text{CH}_3\text{COO}$, and dissolve. Check the pH with a pH meter and adjust if necessary to pH 5.2.

- 3.4. Boron stock standard solution, 100 mg/L
Use of a commercial standard solution is preferable. Alternatively this solution can be prepared by dissolving 0.571 g of boric acid, H_3BO_3 , dried beforehand at 50 °C until constant weight, in 500 mL double distilled water and made up to 1 liter.
- 3.5. Boron standard solution, 1 mg/L
Dilute the stock solution, 100 mg/L (3.4) 1/100 with double distilled water.
- 3.6. Polyvinylpyrrolidone or PVPP (see International Enological Codex)

4. Procedure

Eliminate alcohol from 50 mL of wine by concentration to half the original volume in a rotary evaporator at 40°C and make up to 50 mL with double distilled water. Take 5 mL of this solution and pass it through the PVPP column (2.4). The coloring agents are completely retained. Collect the eluate and the rinsing waters from the column and place in a 50 mL volumetric flask and make up to the mark with water.

The colorimetric determination is performed in a volume of 5 mL of eluent placed in a 25 mL volumetric flask; dilute to approximately 15 mL with double distilled water and add the following (stirring after each addition):

5 mL of azomethin H solution (3.2)

4 mL of pH 5.2 buffer solution (3.3)

Make up to 25 mL with double distilled water.

Wait 30 min and determine the absorbance A_s , at 420 nm. The zero of the absorbance scale is set using distilled water.

Use a blank consisting of 5 mL of azomethin H solution and 4 mL of pH 5.2 buffer solution in 25 mL of double distilled water. Wait 30 min and read the absorbance A_b under the same conditions. The absorbance must be between 0.20 and 0.24; a higher absorbance demonstrates boron contamination in the water or the reagents.

Preparation of the calibration curve

In 25 mL volumetric flasks, place 1 to 10 g of boron, corresponding to 1 to 10 mL of boron standard solution 1 mg/L (3.5) and continue as indicated in 4.0. The calibration graph representing the net absorbance ($A_s - A_b$) in relation to the concentration is a straight line passing through the origin.

Where: A_s = absorbance of sample
 A_b = absorbance of blank

5. Calculations

The µg of boron contained in 5 mL of eluate, (corresponding to 0.5 mL of wine) obtained from interpolating the net absorbance values of ($A_s - A_b$) on the calibration graph is E. The content, B, in milligrams of boron per liter is given by:

$$B \text{ mg/L} = \frac{E}{0.5}$$

BIBLIOGRAPHY

WOLF B., *Soil Science and Plant Analysis*, 1971, **2**(5), 363-374 et 1974, **5**(1), 39-44.
CHARLOT C. and BRUN S., *F.V., O.I.V.*, 1983, n°771.

Free sulphur dioxide
(Resolution OIV-OENO 661-2021)

1 Scope

This method is for the determination of free sulphur dioxide in wine and must.

2 Definitions

Free sulphur dioxide is defined as the sulphur dioxide present in the must or wine in the following forms: H_2SO_3 and HSO_3^- , whose equilibrium is dependent on pH and temperature:



H_2SO_3 represents the molecular sulphur dioxide.

3 Principle

Sulphur dioxide is entrained by a current of air or nitrogen, and is fixed and oxidised by bubbling through a dilute and neutral solution of hydrogen peroxide. The sulphuric acid formed is determined by titration with a standard solution of sodium hydroxide.

The quantity of sulphur dioxide entrained being strongly temperature dependent, the decision was made to work at room temperature (between 18 and 24 °C). This temperature, as for that of the currents of air or nitrogen, should be kept constant throughout the determination.

4 Reagents and products

4.1 Pure phosphoric acid at 85% ($\rho_{20} = 1.71 \text{ g/mL}$) (CAS no. 7664-38-2)

4.2 Diluted phosphoric acid (~25.5%):

By way of example: Dilute 300 mL of phosphoric acid at 85% (4.1) in 1 L of water for analytical use

4.3 Indicator reagent:

Methyl red (CAS no. 493-52-7) 100 mg ($\pm 1 \text{ mg}$)

Methylene blue (CAS no. 7220-79-3) 50 mg ($\pm 0.5 \text{ mg}$)

Ethanol ($\geq 95\%$) (CAS no. 64-17-5) 50 mL

Make up to 100 mL with water for analytical use. Respect the proportions for the volumes that differ from 100 mL.

Commercial indicator reagents with the same composition may be used.

4.4 1 M Sodium hydroxide (3.84%) or in anhydrous form (pellets) (CAS no. 1310-73-2)

4.5 0.01 M Sodium hydroxide solution:

By way of example: Dilute 10.0 mL of 1 M sodium hydroxide (4.4) in 1 L of water for analytical use.

If necessary, check the titre of the solution regularly (correction factor to be applied) and keep it away from atmospheric CO₂.

4.6 Hydrogen peroxide solution in 3 volumes (= 9.1 g/L = 0.27 mol/L H₂O₂), prepared or commercial (e.g. 30% H₂O₂: mixture with CAS no. 7722-84-1)

Note: A solution of 30% by mass corresponds to a titre of 110 volumes ($\rho_{20} \cong 1,11$ g/mL), implying the volume of oxygen ideally released per litre of H₂O₂ under standard conditions of temperature and pressure, while a solution of 3% by mass ($\rho_{20} \cong 1$ g/mL) corresponds to a titre of 10 volumes (0.89 mol/L). The preparation thus depends on the commercial solution used, considering that in any case the volume used in the method will be in excess.

5 Apparatus

The apparatus to be used should conform to the diagram below, especially with regard to the condenser.

The gas supply tube to bubbler B ends in a small sphere of 1 cm in diameter with 20 holes of 0.2 mm in diameter around its largest horizontal circumference. Alternatively, this tube may end in a sintered glass plate that produces a large number of very small bubbles and thus ensures good contact between the liquid and gaseous phases.

The gas flow through the apparatus should be approximately 40 L/h. The bottle situated on the right of the apparatus is intended to restrict the pressure reduction produced by the water pump to 20-30 cm water. In order to regulate the pressure reduction to achieve the proper flow rate, it is preferable to install a flow meter with a semi-capillary tube between the bubbler and the bottle.

Flask A should be kept at a temperature of between 18 °C and 24 °C throughout aspiration. Each flask should consequently be temperature-controlled (e.g. using a thermostatic bath) if the room temperature of the laboratory is not within these limits or if 85% phosphoric acid is used, which can significantly increase the temperature in the flask during addition.

Figure 1 - The dimensions are indicated in millimetres. The internal diameters of the 4 concentric tubes that make up the condenser are 45, 34, 27 and 10 mm.

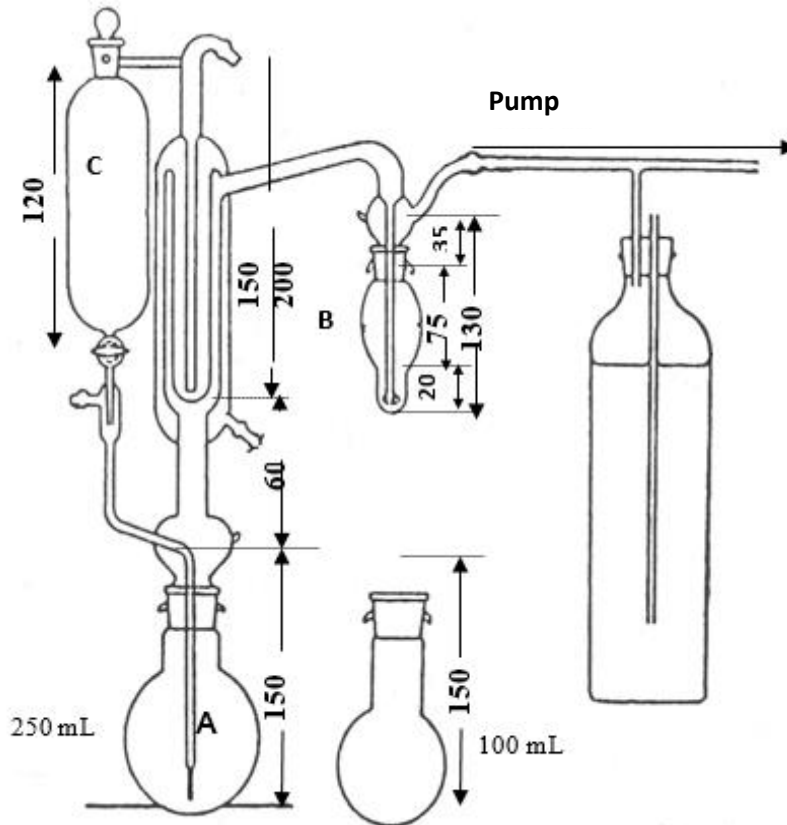

6 Procedure

Air- or nitrogen-rinsing the apparatus before each new determination (e.g. for 5 minutes) is recommended. If a blank test is carried out, the colour of the indicator in the neutralised hydrogen peroxide solution at the exit of the gas-supply tube should not change.

- Connect the water from the condenser.
- Control the laboratory temperature or stabilise the bath in advance (at between 18 °C and 24 °C).
- In bubbler B of the entrainment apparatus, introduce 2-3 mL hydrogen peroxide solution (4.6) and 2 drops of indicator reagent (4.3), and neutralise with the 0.01 M sodium hydroxide solution (4.5); a neutral pH = green colour.
Note: For large sample series, it is also possible to prepare an already neutralised H₂O₂ solution before introducing it into the flask. Adapt the concentrations and volumes accordingly, bearing in mind that the oxidative power of the solution must be maintained (reduced shelf life).
- Adapt this bubbler to the apparatus.
- Transfer 50 mL of sample to the 250-mL flask A and attach it to the apparatus.
- Introduce 15 mL of diluted phosphoric acid (4.2) into bulb C.
- *Note:* If the expected concentration of free sulphur dioxide is higher than 50 mg/L, it is necessary to use phosphoric acid at 85% (4.1). However, ensure that the temperature in flask A does not increase during addition.
- Open the tap to add the acid to the sample while simultaneously starting the gas flow and setting the timer to 15 minutes. The entrained free sulphur dioxide is oxidised into sulphuric acid.
- After 15 minutes, take bubbler B out and rinse the gas supply tube in water (via the socket).
- Titrate the acid formed by the 0.01 M sodium hydroxide solution (4.5) up to the green bend.
- The number of millilitres used is expressed by *n*.

7 Calculation and expression of results

The free sulphur dioxide is expressed in milligrams per litre (mg/L), in whole numbers.

Calculation: Free sulphur dioxide in milligrams per litre: $6.4 n$

8 Bibliography

Paul, F., *Mitt. Klosterneuburg, Rebe u. Wein*, 1958, ser. A, 821.

Collaborative study
Method validation for the determination of free sulphur dioxide

1. Scope of application

An international collaborative study, in accordance with Resolution OIV-OENO 6-2000, for the validation of updates to the methods for the determination of free sulphur dioxide and total sulphur dioxide (OIV-MA-AS323-04A), based on the decision of the OIV “Methods of Analysis” Sub-Commission, April 2018.

2. Standard references

- Update (draft) to the OIV-MA-AS323-04A methods,
- ISO 5725,
- Resolution OIV-OENO 6-2000.

3. Protocol

A total of 20 samples were prepared using homogeneous volumes of 10 wines from various wine regions in France and Portugal. Each sample was made up twice (the second as a blind duplicate), according to the double-blind principle. The samples were prepared between 18 and 20 June 2018, then shipped without delay to the participating laboratories.

Sample no.	Blind duplicate no.	Nature of sample
A	1-14	Dry white wine
B	2-16	Dry white wine
C	3-19	Dry rosé wine
D	4-12	Dry rosé wine
E	5-20	Dry red wine
F	6-18	Dry red wine
G	7-11	Dry red wine
H	8-15	White liqueur wine
I	9-17	Red liqueur wine
J	10-13	Red liqueur wine

The analyses were carried out simultaneously by all participating laboratories between 16 and 20 July 2018. Samples were kept in refrigerated cabinets by all

COMPENDIUM OF INTERNATIONAL METHODS OF ANALYSIS-OIV
Free sulphur dioxide

laboratories between the date of reception and the date of analysis, according to the protocols sent.

The following laboratories provided their results:

Laboratory	City	Country
Estación de Viticultura e Enología de Galicia	Leiro (Ourense)	Spain
Laboratorio arbitral agroalimentario	Madrid	Spain
ASAE	Lisbon	Portugal
SCL Montpellier	Montpellier Cdex 5	France
HBLA und BA für Wein- und Obstbau	Klosterneuburg	Austria
Laboratorio de Salud Pública	Madrid	Spain
Laboratorio Agroambiental de Zaragoza	Zaragoza	Spain
Laboratoire SCL Bordeaux	Pessac Cedex - CS 98080	France
Unione Italiana Vini Servizi	Verona	Italy
Laboratorio Agroalimentario de Valencia	Burjassot (Valencia)	Spain
Agroscope	Nyon	Switzerland
Laboratoires Dubernet	Montredon des Corbières	France
Laboratoire Dioenos Rhône	Orange	France
Laboratoire Natoli	Saint Clément de Rivière	France

NB: The order of laboratories in the table does not correspond with the order in the following tables, in order to preserve the anonymity of results.

COMPENDIUM OF INTERNATIONAL METHODS OF ANALYSIS-OIV
Free sulphur dioxide

4. Free sulphur dioxide

4.1 Free SO₂ data

Free SO ₂ (mg/L)	A		B		C		D		E		F		G		H		I		J	
Sample	1	14	2	16	3	19	4	12	5	20	6	18	7	11	8	15	9	17	10	13
Labo 3			31	36	18	18	21	23	20	18	6	6	20	17	5	6				
Labo 5			37	35	21	24	24	25	20	20	8	7	20	20	3	4				
Labo 6	4	1	38	33	21	20	20	26	19	20	7	6	21	19	7	8	1	3	1	1
Labo 7	1	1	37	40	20	22	24	26	20	22	9	8	20	23	8	8	2	1	1	1
Labo 8			31	32	18	19	23	22	22	20	6	7	19	20	5	3	1	1		
Labo 9			35	34	23	19	25	24	21	24			17	17						
Labo 10	2	1	35	34	20	21	24	24	22	21	9	8	21	20	7	7	2	2	1	1
Labo 11	0	0	33	30	17	11	22	16	16	21	6	4	15	19	6	3	1	1	0	0
Labo 15			15	19	15	13	18	20	8	16	6	5	8	15	5	5				
Labo 17	0	0	37	38	24	26	28	28	26	23	8	8	24	22	7	7	1	2	0	0
Labo 18	0	4	33	31	21	11	23	27	15	19	6	4	9	20	3	4	1	1	0	0
Labo 20	0	0	32	32	20	19	21	21	29	21	8	8	20	18	12	4	1	1	0	0
Labo 21	2	1	33	38	19	15	25	22	19	21	6	6	19	20	8	7	2	1	0	0

Results left blank were rendered non-quantifiable (< limit of quantification).

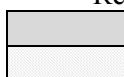

Result removed by the COCHRAN test at 5%

Result removed by the GRUBBS test at 5%

COMPENDIUM OF INTERNATIONAL METHODS OF ANALYSIS-OIV
Free sulphur dioxide

4.2 Free SO₂ results

Free SO₂ (mg/L)	A	B	C	D	E	F	G	H	I	J
No. of laboratories selected	7	9	11	10	10	12	11	11	9	8
No. of repetitions	2	2	2	2	2	2	2	2	2	2
Min.	0	31.5	14	19	17	5	17	3.5	1	0
Max.	2.5	38.5	25	28	24.5	8.5	23	8	2	1
Mean	0.9	34.2	19.8	23.4	20.6	6.8	19.6	5.7	1.4	0.4
Standard deviation	0.98	2.67	2.91	2.46	2.04	1.31	1.77	1.72	0.42	0.52
Repeatability variance	0.79	1.67	2.59	1.20	2.60	0.58	2.23	0.82	0.39	0.00
Inter-laboratory standard deviation	0.98	2.67	2.91	2.46	2.04	1.31	1.77	1.72	0.42	0.52
Reproducibility variance	1.35	7.97	9.76	6.64	5.46	2.00	4.25	3.38	0.37	0.27
Repeatability standard deviation	0.89	1.29	1.61	1.10	1.61	0.76	1.49	0.90	0.62	0.00
r limit	2.48	3.61	4.51	3.07	4.51	2.14	4.18	2.53	1.75	0.00
Repeatability %CV (k=2)	191	8	16	9	16	23	15	32	90	0
Reproducibility standard deviation	1.16	2.82	3.12	2.58	2.34	1.41	2.06	1.84	0.61	0.52
R limit	3.25	7.90	8.75	7.22	6.54	3.96	5.78	5.15	1.70	1.45
Reproducibility %CV (k=2)	250	16	32	22	23	42	21	64	87	276
Horwitz PRSD _R (%)	16.18	9.40	10.21	9.95	10.15	12.00	10.22	12.30	15.23	18.55
Horwitz s _R	0.15	3.22	2.02	2.33	2.09	0.81	2.00	0.70	0.21	0.07
Horwitz R	0.42	9.10	5.71	6.59	5.91	2.29	5.67	1.99	0.60	0.20
Horwitz Ratio	7.64	0.87	1.53	1.10	1.11	1.73	1.02	2.58	2.84	7.37

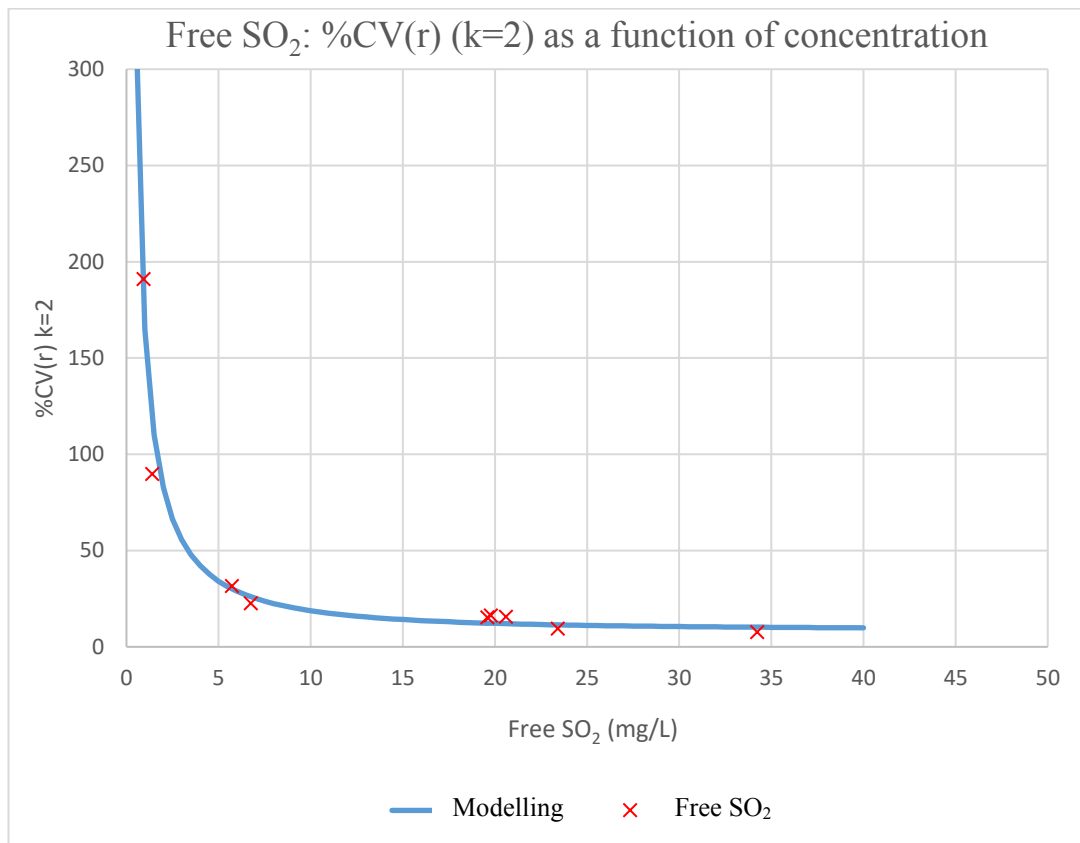

Figure 1: Modelling of the repeatability coefficient of variation, %CV(r) (k=2), as a function of the concentration, C:

$$\%CV(r) = \sqrt{\frac{164.55^2}{C^2} + 9^2}$$

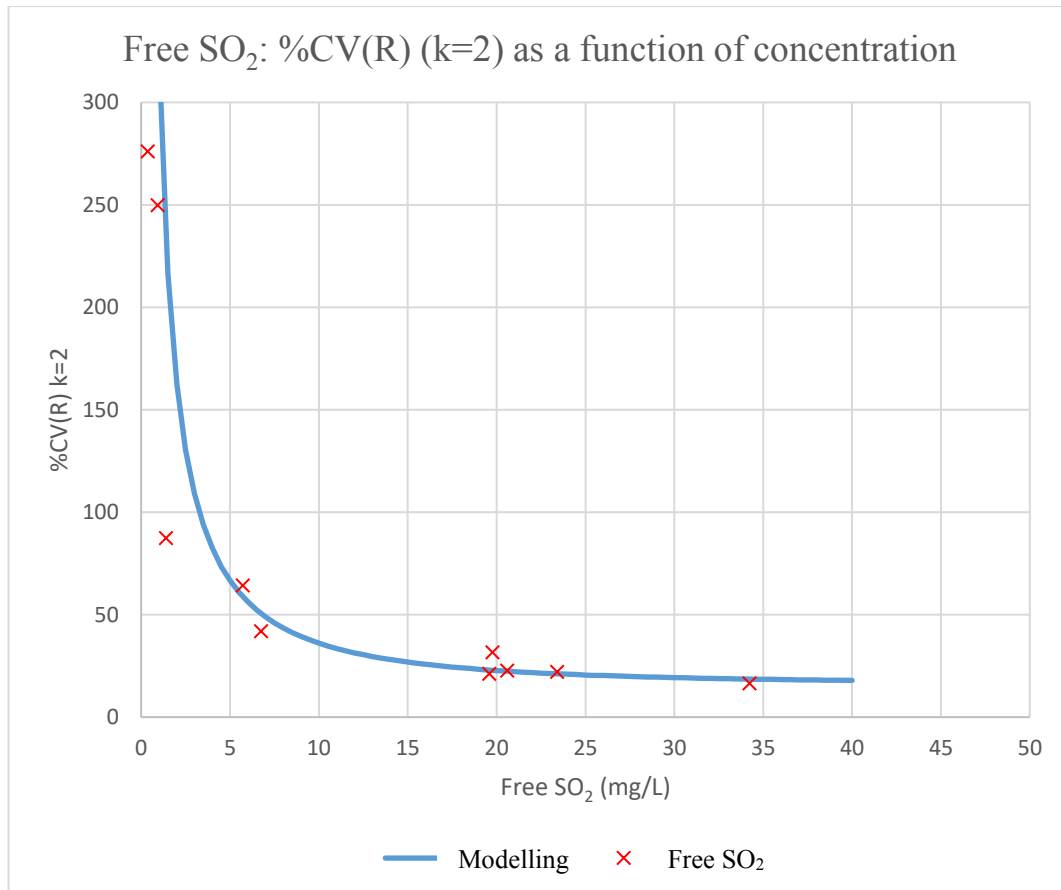

Figure 2: Modelling of the inter-laboratory reproducibility coefficient of variation, %CV(R) (k=2), as a function of concentration, C:

$$\%CV(R) = \sqrt{\frac{323.6^2}{C^2} + 16^2}$$

COMPENDIUM OF INTERNATIONAL METHODS OF ANALYSIS-OIV
Free sulphur dioxide

5. Total sulphur dioxide

5.1. Total SO₂ data

Total SO ₂ (mg/L)	A		B		C		D		E		F		G		H		I		J	
Sample	1	14	2	16	3	19	4	12	5	20	6	18	7	11	8	15	9	17	10	13
Labo 3			128	127	72	73	128	131	61	59	28	28	57	56	102	102	47	45		
Labo 5			122	121	68	71	112	114	42	53	22	22	51	42	102	101	35	34		
Labo 6		1	128	131	72	72	126	131	53	54	22	20	42	49	98	99	31	34	3	1
Labo 7	3	3	131	131	70	74	130	131	54	59	26	23	46	48	106	101	37	40	1	1
Labo 8	2	1	125	127	72	72	129	128	58	57	22	23	46	45	97	99	42	39	1	1
Labo 9			120	128	77	75	132	108	71	59	21	25	44	47	110	99	38	48		
Labo 10	2	2	130	130	74	76	130	130	61	61	28	32	55	56	103	104	43	44	3	4
Labo 11	4	3	119	125	71	74	118	118	39	40	18	21	45	41	89	94	26	38	2	2
Labo 14	3	3	129	128	72	72	127	129	58	58	32	29	50	49	102	101	42	41	3	4
Labo 15			134	136	76	78	134	136	60	58	39	27	52	61	110	106	51	50		
Labo 17	3	3	134	132	82	76	136	133	59	50	24	23	46	44	107	105	35	38	0	0
Labo 18	5	3	130	129	78	73	133	133	62	59	29	32	58	52	105	105	50	48	2	2
Labo 20	1	1	128	131	72	74	130	130	58	56	26	28	48	45	98	93	41	43	0	0
Labo 21		0	124	125	69	72	124	126	45	51	19	20	42	42	97	97	35	34	0	1

Results left blank were rendered non-quantifiable (< limit of quantification).

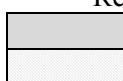

Result removed by the COCHRAN test at 5%

Result removed by the GRUBBS test at 5%

COMPENDIUM OF INTERNATIONAL METHODS OF ANALYSIS-OIV
Free sulphur dioxide

5.2 Total SO₂ results

Total SO₂ (mg/L)	A	B	C	D	E	F	G	H	I	J
No. of laboratories selected	7	12	13	13	8	13	10	13	12	9
No. of repetitions	2	2	2	2	2	2	2	2	2	2
Min.	1	121.5	69.5	113	53.5	19.5	42	91.5	32.5	0
Max.	3.5	135	77	135	61	30.5	56.5	108	50.5	3.5
Mean	2.4	128.8	73.0	128.0	58.3	24.7	47.6	100.9	40.8	1.5
Standard deviation	0.93	3.63	2.20	6.24	2.42	4.04	4.89	4.61	5.80	1.35
Repeatability variance	0.14	1.46	3.27	2.35	1.44	3.04	2.30	3.96	2.21	0.17
Inter-laboratory standard deviation	0.93	3.63	2.20	6.24	2.42	4.04	4.89	4.61	5.80	1.35
Reproducibility variance	0.94	13.93	6.49	40.11	6.57	17.84	25.03	23.28	34.72	1.90
Repeatability standard deviation	0.38	1.21	1.81	1.53	1.20	1.74	1.52	1.99	1.49	0.41
r limit	1.1	3.4	5.1	4.3	3.4	4.9	4.2	5.6	4.2	1.1
Repeatability %CV (k=2)	31	2	5	2	4	14	6	4	7	54
Reproducibility standard deviation	0.97	3.73	2.55	6.33	2.56	4.22	5.00	4.82	5.89	1.38
R limit	2.7	10.5	7.1	17.7	7.2	11.8	14.0	13.5	16.5	3.9
Reproducibility %CV (k=2)	80	6	7	10	9	34	21	10	29	184
Horwitz PRSD _R (%)	14.00	7.70	8.39	7.71	8.68	9.87	8.95	7.99	9.16	15.05
Horwitz s _R	0.34	9.92	6.13	9.86	5.06	2.44	4.26	8.06	3.73	0.23
Horwitz R	0.96	28.05	17.33	27.90	14.31	6.91	12.04	22.80	10.56	0.64
Horwitz Ratio	2.82	0.37	0.41	0.64	0.50	1.71	1.16	0.59	1.56	6.04

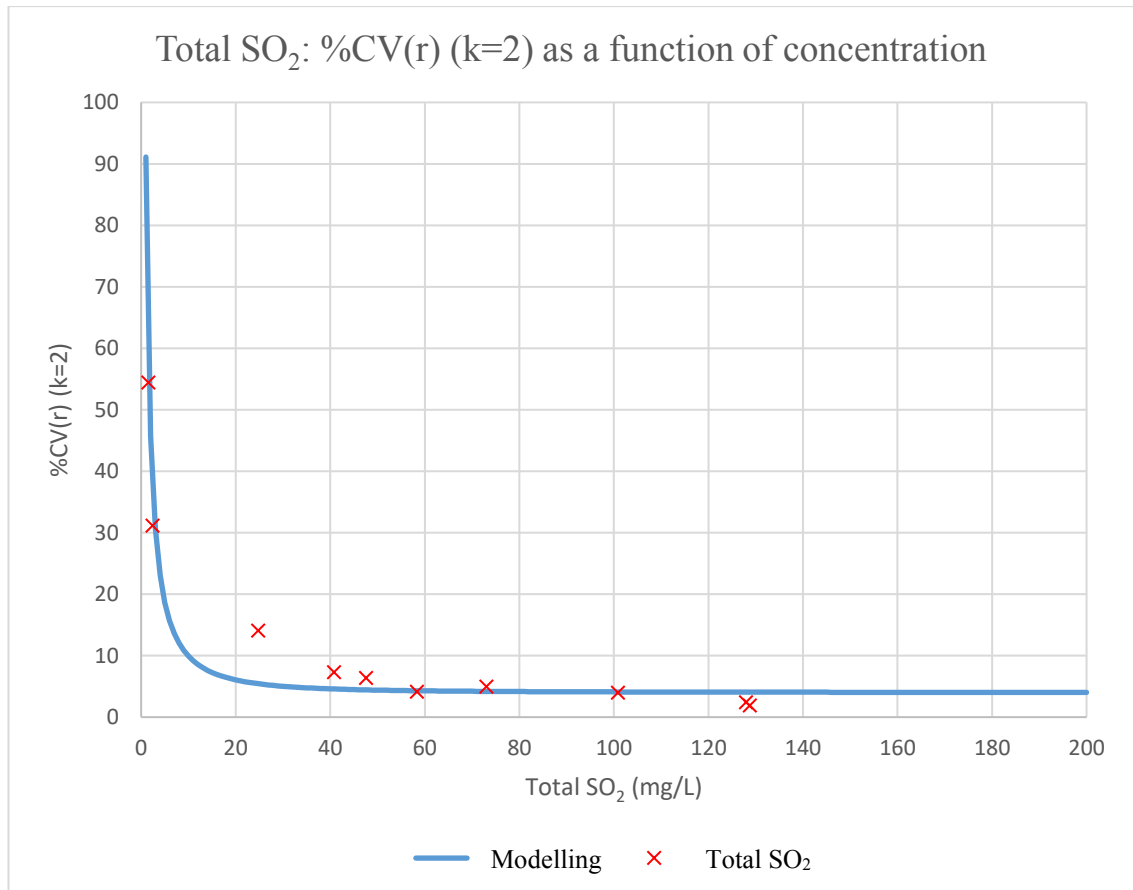

Figure 3: Modelling of the repeatability coefficient of variation, %CV(r) (k=2), as a function of concentration, C:

$$\%CV(r) = \sqrt{\frac{91^2}{C^2} + 4^2}$$

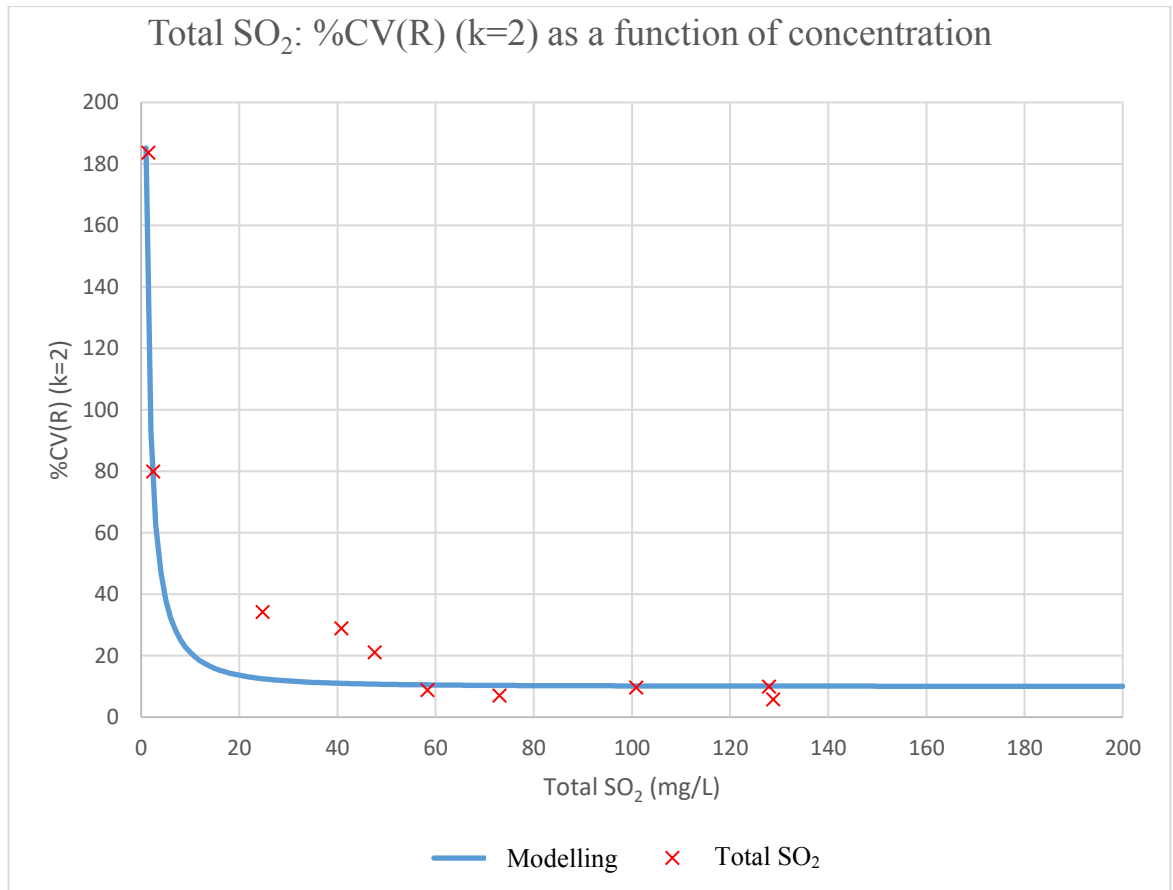

Figure 4: Modelling of the inter-laboratory reproducibility coefficient of variation, %CV_R (k=2), as a function of concentration, C:

$$\%CV(R) = \sqrt{\frac{184.9^2}{C^2} + 10^2}$$

Total sulphur dioxide
(Resolution OIV-OENO 661-2021)

1 Scope

This method is for the determination of total sulphur dioxide in wine and must.

2 Definitions

Total sulphur dioxide is defined as the sum of all of the different forms of sulphur dioxide present in the wine in free form or bound to the wine's constituents.

3 Principle

Sulphur dioxide is aspirated by a current of air or nitrogen, and is captured and oxidised by bubbling through a dilute and neutral solution of hydrogen peroxide. The sulphuric acid formed is determined by titration with a standard solution of sodium hydroxide.

The total sulphur dioxide is extracted from the wine by aspiration at high temperature (around 100 °C).

4 Reagents and products

4.1 Pure phosphoric acid at 85% ($\rho_{20} = 1.71$ g/mL) (CAS no. 7664-38-2)

4.2 Indicator reagent:

Methyl red (CAS no. 493-52-7) 100 mg (± 1 mg)

Methylene blue (CAS no. 7220-79-3) 50 mg (± 0.5 mg)

Ethanol ($\geq 95\%$) (CAS no. 64-17-5) 50 mL

Make up to 100 mL with water for analytical use. Respect the proportions for the volumes that differ from 100 mL.

Commercial indicator reagents with the same composition may be used.

4.3 1 M Sodium hydroxide (3.84%) or in anhydrous form (pellets) (CAS no. 1310-73-2)

4.4 0.01 M Sodium hydroxide solution:

By way of example: Dilute 10.0 mL of 1 M sodium hydroxide (4.4) in 1 L of water for analytical use.

If necessary, check the titre of the solution regularly (correction factor to be applied) and keep it away from atmospheric CO₂.

- 4.5 Hydrogen peroxide solution in 3 volumes (= 9.1 g/L = 0.27 mol/L H₂O₂), prepared or commercial (e.g. 30% H₂O₂: mixture with CAS no. 7722-84-1)

Note: A solution of 30% by mass corresponds to a titre of 110 volumes ($\rho_{20} \cong 1,11$ g/mL), implying the volume of oxygen ideally released per litre of H₂O₂ under standard conditions of temperature and pressure, while a solution of 3% by mass ($\rho_{20} \cong 1$ g/mL) corresponds to a titre of 10 volumes (0.89 mol/L). The preparation thus depends on the commercial solution used, considering that in any case the volume used in the method will be in excess.

5 Apparatus

The apparatus to be used should conform to the diagram below, especially with regard to the condenser.

The gas supply tube to bubbler B ends in a small sphere of 1 cm in diameter with 20 holes of 0.2 mm in diameter around its largest horizontal circumference. Alternatively, this tube may end in a sintered glass plate that produces a large number of very small bubbles and thus ensures good contact between the liquid and gaseous phases.

The gas flow through the apparatus should be approximately 40 L/h. The bottle situated on the right of the apparatus is intended to restrict the pressure reduction produced by the water pump to 20-30 cm water. In order to regulate the pressure reduction to achieve the proper flow rate, it is preferable to install a flow meter with a semi-capillary tube between the bubbler and the bottle. For the determination of total sulphur dioxide, using a burner (with a 4-5 cm high flame or infrared) allowing for boiling point to be reached very quickly is preferable. Do not place a wire gauze under flask A, but rather a deflector with a 2-4 cm orifice. The pyrogenation of non-volatile matter in the wine on the flask walls is thus avoided.

Use a 250-mL flask for a 50 mL sample and a 100-150 mL flask for a 20 mL sample.

Figure 1 - The dimensions are indicated in millimetres. The internal diameters of the 4 concentric tubes that make up the condenser are 45, 34, 27 and 10 mm.

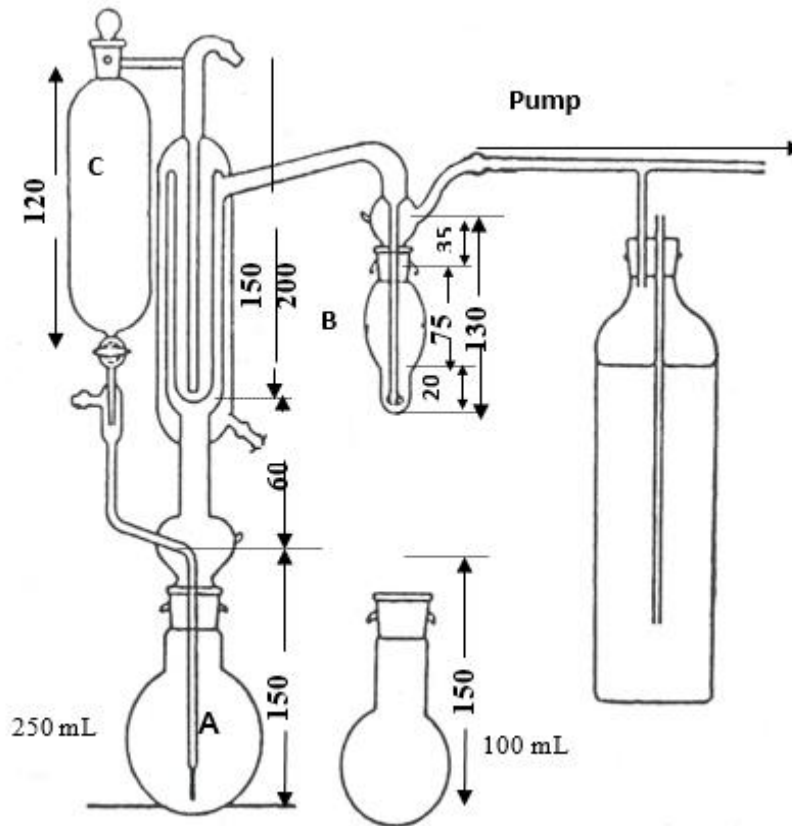

6 Procedure

Air- or nitrogen-rinsing the apparatus before each new determination (e.g. for 5 minutes) is recommended. If a blank test is carried out, the colour of the indicator in the neutralised hydrogen peroxide solution at the exit of the gas-supply tube should not change.

- Connect the water from the condenser.
- In bubbler B of the entrainment apparatus, introduce 2-3 mL hydrogen peroxide solution (4.5) and 2 drops of indicator reagent (4.2), and neutralise with the 0.01 M sodium hydroxide solution (4.4); a neutral pH = green colour.
Note: For large sample series, it is also possible to prepare an already neutralised H₂O₂ solution before introducing it into the flask. Adapt the concentrations and volumes accordingly, bearing in mind that the oxidative power of the solution must be maintained (reduced shelf life).
- Adapt this bubbler to the apparatus.
- Transfer 50 mL of sample to flask A if the presumed total SO₂ content in the sample is < 50 mg/L, and 20 mL of sample if the presumed total SO₂ content is ≥ 50 mg/L and attach it to the apparatus.
- Introduce 15 mL of phosphoric acid (4.1) into bulb C if the presumed total SO₂ content of the sample is < 50 mg/L and 5 mL phosphoric acid (4.1) if the presumed total SO₂ content of the sample is ≥ 50 mg/L.
- Open the tap to add the acid to the sample and activate the heat source, while simultaneously starting the gas flow and setting the timer to 15 minutes. Maintain at boiling point for the duration of the gas flow. The entrained total sulphur dioxide is oxidised into sulphuric acid.
- After 15 minutes, turn off the heat source, take bubbler B out, and rinse the gas supply tube (via the socket) with water.
- Titrate the acid formed by the 0.01 M sodium hydroxide solution (4.4) up to the green bend.

The number of millilitres used is expressed by *n*.

7 Calculations and expression of results

The total sulphur dioxide is expressed in milligrams per litre (mg/L), in whole numbers.

Calculations:

- Samples low in sulphur dioxide (50 mL sampling): 6.4 *n*
- Other samples (20 mL sampling): 16 *n*

8 Precision

8.1 Repeatability (r)

Content < 50 mg/L (50 mL sampling), r = 1 mg/L

Content ≥ 50 mg/L (20 mL sampling), r = 6 mg/L

8.2 Reproducibility (R)

Content < 50 mg/L (50 mL sampling), R = 9 mg/L

Content ≥ 50 mg/L (20 mL sampling), R = 15 mg/L

9 Bibliography

Paul, F., *Mitt. Klosterneuburg, Rebe u. Wein*, 1958, ser. A, 821.

Collaborative study

1. Scope of application

An international collaborative study, in accordance with Resolution OIV-OENO 6-2000, for the validation of updates to the methods for the determination of free sulphur dioxide and total sulphur dioxide (OIV-MA-AS323-04A), based on the decision of the OIV “Methods of Analysis” Sub-Commission, April 2018.

2. Standard references

- Update (draft) to the OIV-MA-AS323-04A methods,
- ISO 5725,
- Resolution OIV-OENO 6-2000.

3. Protocol

A total of 20 samples were prepared using homogeneous volumes of 10 wines from various wine regions in France and Portugal. Each sample was made up twice (the second as a blind duplicate), according to the double-blind principle. The samples were prepared between 18 and 20 June 2018, then shipped without delay to the participating laboratories.

Sample no.	Blind duplicate no.	Nature of sample
A	1-14	Dry white wine
B	2-16	Dry white wine
C	3-19	Dry rosé wine
D	4-12	Dry rosé wine
E	5-20	Dry red wine
F	6-18	Dry red wine
G	7-11	Dry red wine
H	8-15	White liqueur wine
I	9-17	Red liqueur wine
J	10-13	Red liqueur wine

The analyses were carried out simultaneously by all participating laboratories between 16 and 20 July 2018. Samples were kept in refrigerated cabinets by all

COMPENDIUM OF INTERNATIONAL METHODS OF ANALYSIS-OIV
Total sulphur dioxide

laboratories between the date of reception and the date of analysis, according to the protocols sent.

The following laboratories provided their results:

Laboratory	City	Country
Estación de Viticultura e Enología de Galicia	Leiro (Ourense)	Spain
Laboratorio arbitral agroalimentario	Madrid	Spain
ASAE	Lisbon	Portugal
SCL Montpellier	Montpellier Cdex 5	France
HBLA und BA für Wein- und Obstbau	Klosterneuburg	Austria
Laboratorio de Salud Pública	Madrid	Spain
Laboratorio Agroambiental de Zaragoza	Zaragoza	Spain
Laboratoire SCL Bordeaux	Pessac Cedex - CS 98080	France
Unione Italiana Vini Servizi	Verona	Italy
Laboratorio Agroalimentario de Valencia	Burjassot (Valencia)	Spain
Agroscope	Nyon	Switzerland
Laboratoires Dubernet	Montredon des Corbières	France
Laboratoire Dioenos Rhône	Orange	France
Laboratoire Natoli	Saint Clément de Rivière	France

NB: The order of laboratories in the table does not correspond with the order in the following tables, in order to preserve the anonymity of results.

COMPENDIUM OF INTERNATIONAL METHODS OF ANALYSIS-OIV
Total sulphur dioxide

4. Free sulphur dioxide

4.1 Free SO₂ data

Free SO ₂ (mg/L)	A		B		C		D		E		F		G		H		I		J	
Sample	1	14	2	16	3	19	4	12	5	20	6	18	7	11	8	15	9	17	10	13
Labo 3			31	36	18	18	21	23	20	18	6	6	20	17	5	6				
Labo 5			37	35	21	24	24	25	20	20	8	7	20	20	3	4				
Labo 6	4	1	38	33	21	20	20	26	19	20	7	6	21	19	7	8	1	3	1	1
Labo 7	1	1	37	40	20	22	24	26	20	22	9	8	20	23	8	8	2	1	1	1
Labo 8			31	32	18	19	23	22	22	20	6	7	19	20	5	3	1	1		
Labo 9			35	34	23	19	25	24	21	24			17	17						
Labo 10	2	1	35	34	20	21	24	24	22	21	9	8	21	20	7	7	2	2	1	1
Labo 11	0	0	33	30	17	11	22	16	16	21	6	4	15	19	6	3	1	1	0	0
Labo 15			15	19	15	13	18	20	8	16	6	5	8	15	5	5				
Labo 17	0	0	37	38	24	26	28	28	26	23	8	8	24	22	7	7	1	2	0	0
Labo 18	0	4	33	31	21	11	23	27	15	19	6	4	9	20	3	4	1	1	0	0
Labo 20	0	0	32	32	20	19	21	21	29	21	8	8	20	18	12	4	1	1	0	0
Labo 21	2	1	33	38	19	15	25	22	19	21	6	6	19	20	8	7	2	1	0	0

Results left blank were rendered non-quantifiable (< limit of quantification).

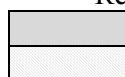

Result removed by the COCHRAN test at 5%

Result removed by the GRUBBS test at 5%

COMPENDIUM OF INTERNATIONAL METHODS OF ANALYSIS-OIV
Total sulphur dioxide

4.2 Free SO₂ results

Free SO₂ (mg/L)	A	B	C	D	E	F	G	H	I	J
No. of laboratories selected	7	9	11	10	10	12	11	11	9	8
No. of repetitions	2	2	2	2	2	2	2	2	2	2
Min.	0	31.5	14	19	17	5	17	3.5	1	0
Max.	2.5	38.5	25	28	24.5	8.5	23	8	2	1
Mean	0.9	34.2	19.8	23.4	20.6	6.8	19.6	5.7	1.4	0.4
Standard deviation	0.98	2.67	2.91	2.46	2.04	1.31	1.77	1.72	0.42	0.52
Repeatability variance	0.79	1.67	2.59	1.20	2.60	0.58	2.23	0.82	0.39	0.00
Inter-laboratory standard deviation	0.98	2.67	2.91	2.46	2.04	1.31	1.77	1.72	0.42	0.52
Reproducibility variance	1.35	7.97	9.76	6.64	5.46	2.00	4.25	3.38	0.37	0.27
Repeatability standard deviation	0.89	1.29	1.61	1.10	1.61	0.76	1.49	0.90	0.62	0.00
r limit	2.48	3.61	4.51	3.07	4.51	2.14	4.18	2.53	1.75	0.00
Repeatability %CV (k=2)	191	8	16	9	16	23	15	32	90	0
Reproducibility standard deviation	1.16	2.82	3.12	2.58	2.34	1.41	2.06	1.84	0.61	0.52
R limit	3.25	7.90	8.75	7.22	6.54	3.96	5.78	5.15	1.70	1.45
Reproducibility %CV (k=2)	250	16	32	22	23	42	21	64	87	276
Horwitz PRSD _R (%)	16.18	9.40	10.21	9.95	10.15	12.00	10.22	12.30	15.23	18.55
Horwitz s _R	0.15	3.22	2.02	2.33	2.09	0.81	2.00	0.70	0.21	0.07
Horwitz R	0.42	9.10	5.71	6.59	5.91	2.29	5.67	1.99	0.60	0.20
Horwitz Ratio	7.64	0.87	1.53	1.10	1.11	1.73	1.02	2.58	2.84	7.37

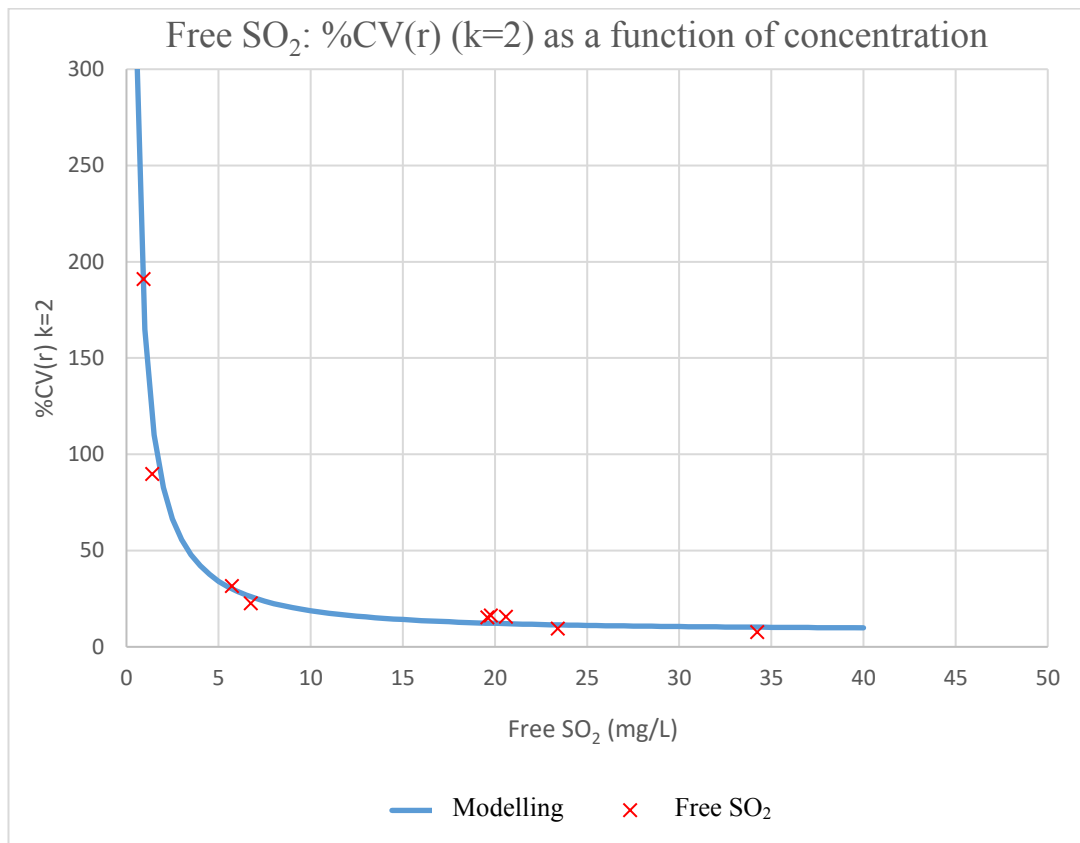

Figure 1: Modelling of the repeatability coefficient of variation, %CV(r) (k=2), as a function of the concentration, C:

$$\%CV(r) = \sqrt{\frac{164.55^2}{C^2} + 9^2}$$

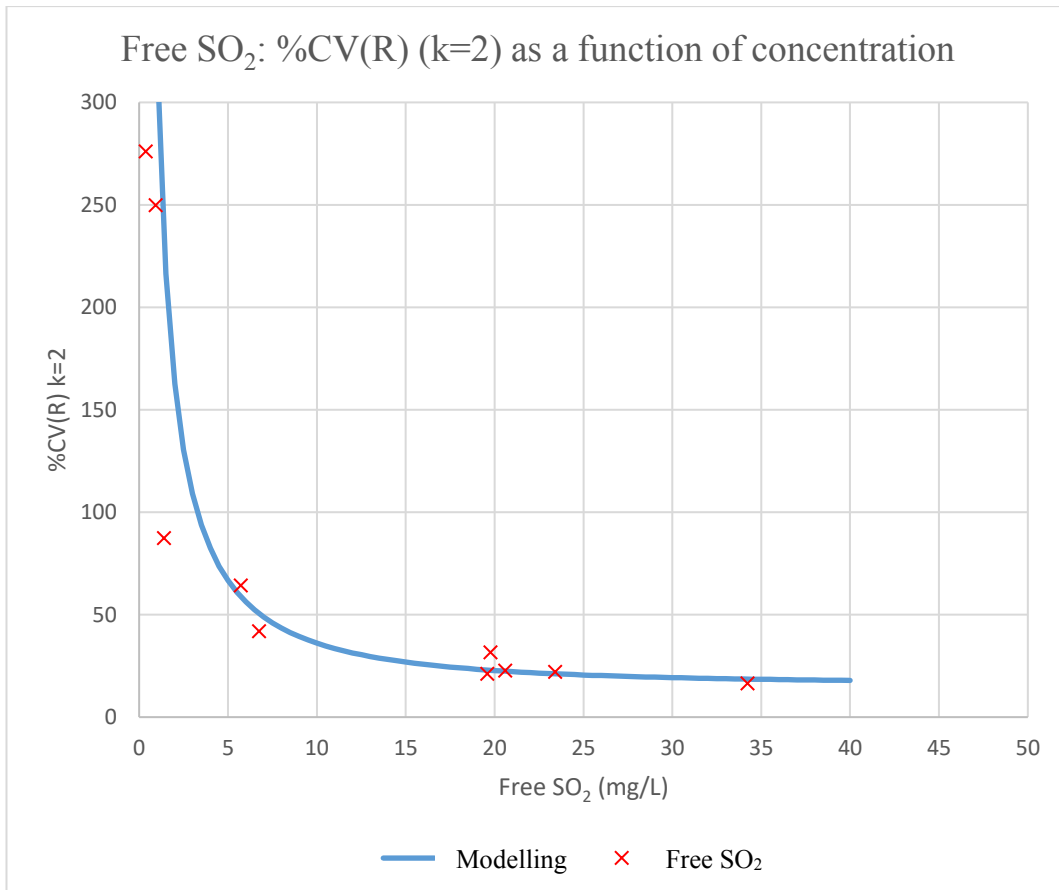

Figure 2: Modelling of the inter-laboratory reproducibility coefficient of variation, %CV(R) (k=2), as a function of concentration, C:

$$\%CV(R) = \sqrt{\frac{323.6^2}{C^2} + 16^2}$$

COMPENDIUM OF INTERNATIONAL METHODS OF ANALYSIS-OIV
Total sulphur dioxide

5. Total sulphur dioxide
5.1. Total SO₂ data

Total SO ₂ (mg/L)	A		B		C		D		E		F		G		H		I		J	
Sample	1	14	2	16	3	19	4	12	5	20	6	18	7	11	8	15	9	17	10	13
Labo 3			128	127	72	73	128	131	61	59	28	28	57	56	102	102	47	45		
Labo 5			122	121	68	71	112	114	42	53	22	22	51	42	102	101	35	34		
Labo 6		1	128	131	72	72	126	131	53	54	22	20	42	49	98	99	31	34	3	1
Labo 7	3	3	131	131	70	74	130	131	54	59	26	23	46	48	106	101	37	40	1	1
Labo 8	2	1	125	127	72	72	129	128	58	57	22	23	46	45	97	99	42	39	1	1
Labo 9			120	128	77	75	132	108	71	59	21	25	44	47	110	99	38	48		
Labo 10	2	2	130	130	74	76	130	130	61	61	28	32	55	56	103	104	43	44	3	4
Labo 11	4	3	119	125	71	74	118	118	39	40	18	21	45	41	89	94	26	38	2	2
Labo 14	3	3	129	128	72	72	127	129	58	58	32	29	50	49	102	101	42	41	3	4
Labo 15			134	136	76	78	134	136	60	58	39	27	52	61	110	106	51	50		
Labo 17	3	3	134	132	82	76	136	133	59	50	24	23	46	44	107	105	35	38	0	0
Labo 18	5	3	130	129	78	73	133	133	62	59	29	32	58	52	105	105	50	48	2	2
Labo 20	1	1	128	131	72	74	130	130	58	56	26	28	48	45	98	93	41	43	0	0
Labo 21		0	124	125	69	72	124	126	45	51	19	20	42	42	97	97	35	34	0	1

Results left blank were rendered non-quantifiable (< limit of quantification).

	Result removed by the COCHRAN test at 5%
	Result removed by the GRUBBS test at 5%

COMPENDIUM OF INTERNATIONAL METHODS OF ANALYSIS-OIV
Total sulphur dioxide

5.2 Total SO₂ results

Total SO₂ (mg/L)	A	B	C	D	E	F	G	H	I	J
No. of laboratories selected	7	12	13	13	8	13	10	13	12	9
No. of repetitions	2	2	2	2	2	2	2	2	2	2
Min.	1	121.5	69.5	113	53.5	19.5	42	91.5	32.5	0
Max.	3.5	135	77	135	61	30.5	56.5	108	50.5	3.5
Mean	2.4	128.8	73.0	128.0	58.3	24.7	47.6	100.9	40.8	1.5
Standard deviation	0.93	3.63	2.20	6.24	2.42	4.04	4.89	4.61	5.80	1.35
Repeatability variance	0.14	1.46	3.27	2.35	1.44	3.04	2.30	3.96	2.21	0.17
Inter-laboratory standard deviation	0.93	3.63	2.20	6.24	2.42	4.04	4.89	4.61	5.80	1.35
Reproducibility variance	0.94	13.93	6.49	40.11	6.57	17.84	25.03	23.28	34.72	1.90
Repeatability standard deviation	0.38	1.21	1.81	1.53	1.20	1.74	1.52	1.99	1.49	0.41
r limit	1.1	3.4	5.1	4.3	3.4	4.9	4.2	5.6	4.2	1.1
Repeatability %CV (k=2)	31	2	5	2	4	14	6	4	7	54
Reproducibility standard deviation	0.97	3.73	2.55	6.33	2.56	4.22	5.00	4.82	5.89	1.38
R limit	2.7	10.5	7.1	17.7	7.2	11.8	14.0	13.5	16.5	3.9
Reproducibility %CV (k=2)	80	6	7	10	9	34	21	10	29	184
Horwitz PRSD _R (%)	14.00	7.70	8.39	7.71	8.68	9.87	8.95	7.99	9.16	15.05
Horwitz s _R	0.34	9.92	6.13	9.86	5.06	2.44	4.26	8.06	3.73	0.23
Horwitz R	0.96	28.05	17.33	27.90	14.31	6.91	12.04	22.80	10.56	0.64
Horwitz Ratio	2.82	0.37	0.41	0.64	0.50	1.71	1.16	0.59	1.56	6.04

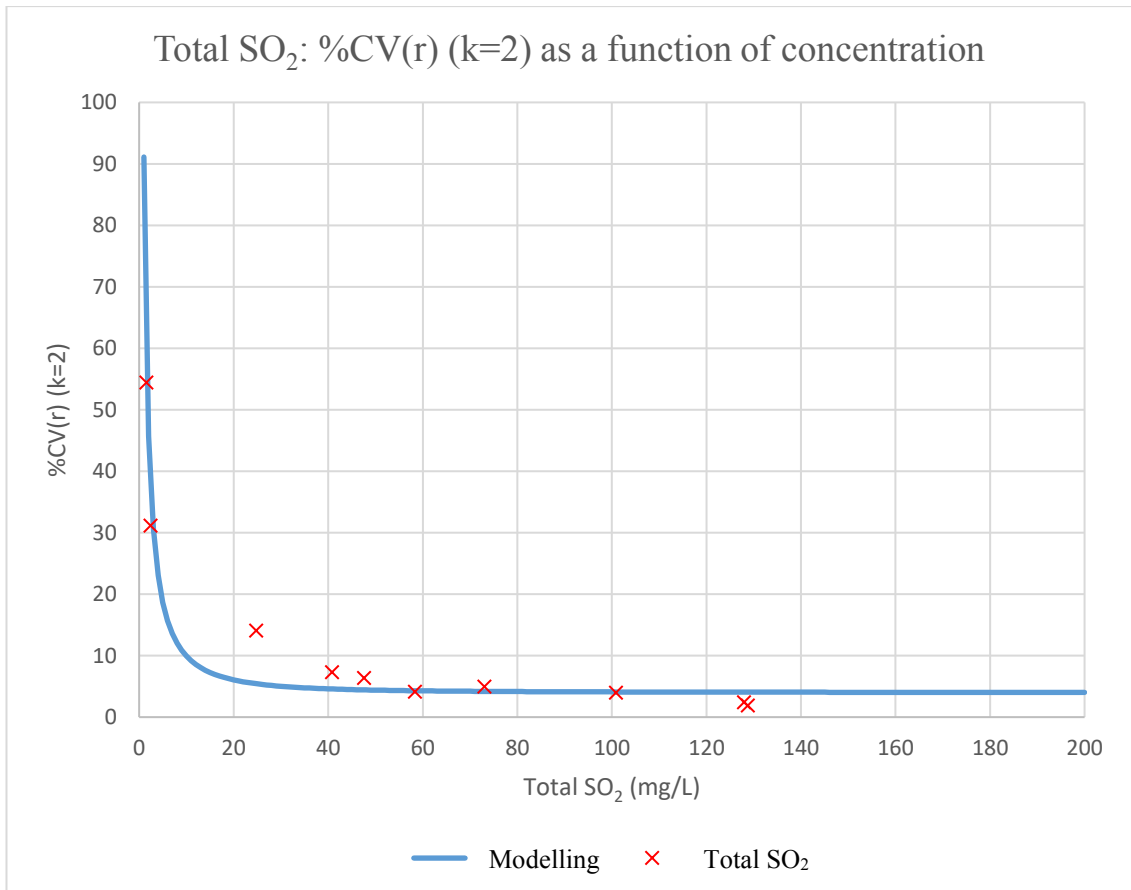

Figure 3: Modelling of the repeatability coefficient of variation, %CV(r) (k=2), as a function of concentration, C:

$$\%CV(r) = \sqrt{\frac{91^2}{C^2} + 4^2}$$

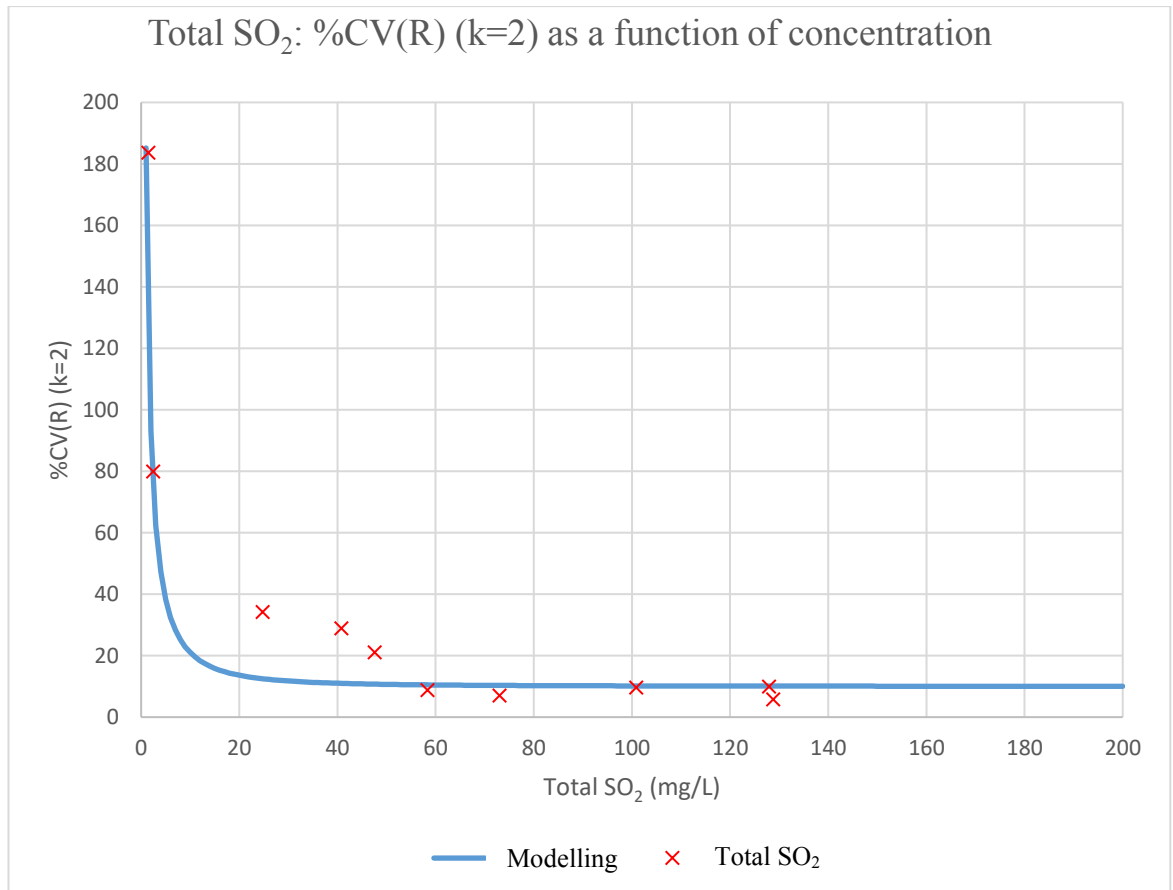

Figure 4: Modelling of the inter-laboratory reproducibility coefficient of variation, %CV_R (k=2), as a function of concentration, C:

$$\%CV(R) = \sqrt{\frac{184.9^2}{C^2} + 10^2}$$

Sulfur dioxide
(Resolution Oeno 377/2009)

1. Definitions

Free sulfur dioxide is defined as the sulfur dioxide present in the must or wine in the following forms: H_2SO_3 , HSO_3^- , whose equilibrium as a function of pH and temperature is:



H_2SO_3 represents molecular sulfur dioxide.

Total sulfur dioxide is defined as the total of all the various forms of sulfur dioxide present in the wine, either in the free state or combined with their constituents.

2. Free and Total Sulfur Dioxide

2.1 Principle

Free sulfur dioxide is determined by direct titration with iodine. The combined sulfur dioxide is subsequently determined by iodometric titration after alkaline hydrolysis. When added to the free sulfur dioxide, it gives the total sulfur dioxide.

2.2 Rapid Method

2.2.1 Reagents

2.2.1.1 EDTA: ethylenediaminetetraacetic acid, *di*-sodium salt

2.2.1.2 4 M Sodium hydroxide solution (160 g/L).

2.2.1.3 Dilute sulfuric acid: 10% sulfuric acid ($\rho_{20} = 1.84$ g/mL) diluted 10% (v/v).

2.2.1.4 Starch solution, 5 g/L.

Mix 5 g starch with approx. 500 mL water. Bring to a boil stirring continuously and keep boiling for 10 minutes. Add 200 g of sodium chloride. Cool and make to 1 liter.

2.2.1.5 0.025 M Iodine solution

2.2.2 Free sulfur dioxide

Place in a 500 mL conical flask place:

- 50 mL of wine
- 5 mL starch solution
- 30 mg EDTA
- 3 mL H_2SO_4

Immediately titrate with 0.025 M iodine, until the blue color persists clearly for 10 to 15 seconds. Let n mL be the volume of iodine used.

2.2.3 *Combined sulfur dioxide*

Add 8 mL of 4 M sodium hydroxide solution, shake the mixture once and allow to stand for 5 minutes. Add, with vigorous stirring and in one operation, the contents of a small beaker in which 10 mL of sulfuric acid have been placed. Titrate immediately with the 0.025 M iodine solution; let n' be the volume used.

Add 20 mL of sodium hydroxide solution, shake once and allow to stand for 5 minutes. Dilute with 200 mL of ice-cold water.

Add, while stirring vigorously and in one operation, the contents of a test tube in which 30 mL sulfuric acid has previously been placed. Titrate the free sulfur dioxide immediately with the 0.025 M iodine, and let n'' be the volume of iodine used.

2.2.4 *Expression of the results*

2.2.4.1 Calculation

Free sulfur dioxide in milligrams per liter is given by:

$$32 \cdot n$$

Total sulfur dioxide in milligrams per liter is given by:

$$32 (n + n' + n'')$$

Remarks:

1. For red wines with low SO₂ concentrations, the 0.025 M iodine may be diluted (for example: 0.01 M). In this case, replace the coefficient 32 by 12.8 in the above formula.
2. For red wines, it is useful to illuminate the wine from below with a beam of yellow light from an ordinary electric light bulb shining through a solution of potassium chromate or from a sodium vapor lamp. The determination should be carried out in a dark room and the transparency of the wine observed: it becomes opaque when the starch endpoint is reached.
3. If the quantity of sulfur dioxide found is close to or exceeds the legal limit, the total sulfur dioxide should be determined with the reference method.
4. If the determination of free sulfur dioxide is specifically required, carry out a determination on a sample kept under anaerobic conditions for two days at 20 °C before analysis. Carry out the determination at 20 °C.
5. Because certain substances are oxidized by iodine in an acid medium, the quantity of iodine used in this way must be assessed for more accurate determinations. To achieve this, combine the free sulfur dioxide in an

excess of ethanal or propanal before beginning the titration with iodine. Place 50 mL of wine into a 300 mL conical flask, add 5 mL of 7 g/L ethanol solution or 5 mL of a 10 g/L propanal solution.

Stopper the flask and allow to stand for at least 30 minutes. Add 3 mL of sulfuric acid and sufficient iodine, 0.025 M, to cause the starch to change color. Let n'' mL be the volume of iodine used. This must be subtracted from n (free sulfur dioxide), and from $n + n' + n''$ (total sulfur dioxide).

n'' is generally small, from 0.2 to 0.3 mL of 0.025 M iodine. If ascorbic acid has been added to the wine, n'' will be much higher and it is possible, at least approximately, to measure the amount of this substance from the value of n'' given that 1 mL of 0.025 M iodine will oxidize 4.4 mg ascorbic acid. By determining n'' , it is possible to detect quite easily the presence of residual ascorbic acid in amounts greater than 20 mg/L, in wines to which it has been added.

BIBLIOGRAPHY

Rapid method:

RIPPER M., *J. Prakt. Chem.*, 1892, **46**, 428.

JAULMES, P., DIEUZEIDE J.-C., *Ann. Fals. Fraudes*, 1954, **46**, 9; *Bull. O.I.V.*, 1953, **26**, n° 274, 52.

KIELHOFER E., AUMANN H., *Mitt. Klosterneuburg, Rebe u. Wein*, 1957, **7**, 289.

JAULMES P., HAMELLE M^{me} G., *Ann. Fals. Exp. Chim.*, 1961, **54**, 338

Sulfur dioxide
(Resolution Oeno 377/2009)

1. Definitions

Free sulfur dioxide is defined as the sulfur dioxide present in the must or wine in the following forms: H_2SO_3 , HSO_3^- , whose equilibrium as a function of pH and temperature is:



H_2SO_3 represents molecular sulfur dioxide.

Total sulfur dioxide is defined as the total of all the various forms of sulfur dioxide present in the wine, either in the free state or combined with their constituents.

2 Molecular Sulfur Dioxide

2.1 Principle of the Method

The percentage of molecular sulfur dioxide, H_2SO_3 , in free sulfur dioxide, is calculated as a function of pH, alcoholic strength and temperature.

For a given temperature and the alcoholic strength:

$$\begin{aligned} \text{H}_2\text{SO}_3 &\rightleftharpoons \text{H}^+ + \text{HSO}_3^- \\ [\text{H}_2\text{SO}_3] &= \frac{L}{10^{(\text{pH} - \text{p}k_M)} + 1} \end{aligned} \quad (1)$$

where

$$L = [\text{H}_2\text{SO}_3] + [\text{HSO}_3^-]$$

$$\text{p}k_M = \text{p}k_T - \frac{A \sqrt{I}}{I + B \sqrt{I}}$$

I = ionic strength

A & B = Coefficients which vary according to temperature and alcoholic strength.

k_T = Thermodynamic dissociation constant; the value of $\text{p}k_T$ is given in Table 1 for various alcoholic strengths and temperatures.

k_M = Mixed dissociation constant

Taking a mean value 0.038 for the ionic strength I, Table 2 gives the values of $\text{p}k_M$ for various temperatures and alcoholic strengths.

COMPENDIUM OF INTERNATIONAL METHODS OF ANALYSIS - OIV
Sulfur dioxide

The molecular sulfur dioxide content calculated by the relationship given in (1) is presented in Table 3 for various values of pH, temperature and alcoholic strength.

2.2 Calculations

Knowing the pH of wine and its alcoholic strength, the percentage of molecular sulfur dioxide is given in Table 3 for a temperature t °C. Let this be X %.

The amount of molecular sulfur dioxide in mg/L is given by: $X \cdot C$

C = the free sulfur dioxide in mg/L

Table I

Values of the thermodynamic constant pK_T

Alcohol % by volume	Temperature °C				
	20	25	30	35	40
0	1.798	2.000	2.219	2.334	2.493
5	1.897	2.098	2.299	2.397	2.527
10	1.997	2.198	2.394	2.488	2.606
15	2.099	2.301	2.503	2.607	2.728
20	2.203	2.406	2.628	2.754	2.895

Table II

Values of the Mixed Dissociation Constant pK_M ($I= 0.038$)

Alcohol % by volume	Temperature °C				
	20	25	30	35	40
0	1.723	1.925	2.143	2.257	2.416
5	1.819	2.020	2.220	2.317	2.446
10	1.916	2.116	2.311	2.405	2.522
15	2.014	2.216	2.417	2.520	2.640
20	2.114	2.317	2.538	2.663	2.803

COMPENDIUM OF INTERNATIONAL METHODS OF ANALYSIS - OIV
Sulfur dioxide

Table III
Molecular Sulfur Dioxide as a Percentage of Free Sulfur Dioxide (I=0.038)

pH	T = 20 °C Alcohol % by volume				
		0	10	15	20
2.8	7.73	9.46	11.55	14.07	17.09
2.9	6.24	7.66	9.40	11.51	14.07
3.0	5.02	6.18	7.61	9.36	11.51
3.1	4.03	4.98	6.14	7.58	9.36
3.2	3.22	3.99	4.94	6.12	7.58
3.3	2.58	3.20	3.98	4.92	6.12
3.4	2.06	2.56	3.18	3.95	4.92
3.5	1.64	2.04	2.54	3.16	3.95
3.6	1.31	1.63	2.03	2.53	3.16
3.7	1.04	1.30	1.62	2.02	2.53
3.8	0.83	1.03	1.29	1.61	2.02
T = 25 °C					
2.8	11.47	14.23	17.15	20.67	24.75
2.9	9.58	11.65	14.12	17.15	22.71
3.0	7.76	9.48	11.55	14.12	17.18
3.1	6.27	7.68	9.40	11.55	14.15
3.2	5.04	6.20	7.61	9.40	11.58
3.3	4.05	4.99	6.14	7.61	9.42
3.4	3.24	4.00	4.94	6.14	7.63
3.5	2.60	3.20	3.97	4.94	6.16
3.6	2.07	2.56	3.18	3.97	4.55
3.7	1.65	2.05	2.54	3.18	3.98
3.8	1.32	1.63	2.03	2.54	3.18
T = 30 °C					
2.8	18.05	20.83	24.49	29.28	35.36
2.9	14.89	17.28	20.48	24.75	30.29
3.0	12.20	14.23	16.98	20.71	25.66
3.1	9.94	11.65	13.98	17.18	21.52
3.2	8.06	9.48	11.44	14.15	17.88
3.3	6.51	7.68	9.30	11.58	14.75
3.4	5.24	6.20	7.53	9.42	12.08
3.5	4.21	4.99	6.08	7.63	9.84
3.6	3.37	4.00	4.89	6.16	7.98
3.7	2.69	3.21	3.92	4.95	6.44
3.8	2.16	2.56	3.14	3.98	5.19

COMPENDIUM OF INTERNATIONAL METHODS OF ANALYSIS - OIV
Sulfur dioxide

Table III (continued)

Molecular Sulfur Dioxide as a Percentage of Free Sulfur Dioxide (I=0.038)

pH	T=35 °C				
	Alcohol % by volume				
	0	5	10	15	20
2.8	22.27	24.75	28.71	34.42	42.18
2.9	18.53	20.71	24.24	29.42	36.69
3.0	15.31	17.18	20.26	24.88	31.52
3.1	12.55	14.15	16.79	20.83	26.77
3.2	10.24	11.58	13.82	17.28	22.51
3.3	8.31	9.42	11.30	14.23	18.74
3.4	6.71	7.63	9.19	11.65	15.49
3.5	5.44	6.16	7.44	9.48	12.71
3.6	4.34	4.95	6.00	7.68	10.36
3.7	3.48	3.98	4.88	6.20	8.41
3.8	2.78	3.18	3.87	4.99	6.80
T = 40 °C					
2.8	29.23	30.68	34.52	40.89	50.14
2.9	24.70	26.01	29.52	35.47	44.74
3.0	20.67	21.83	24.96	30.39	38.85
3.1	17.15	18.16	20.90	25.75	33.54
3.2	14.12	14.98	17.35	21.60	28.62
3.3	11.55	12.28	14.29	17.96	24.15
3.4	9.40	10.00	11.70	14.81	20.19
3.5	7.61	8.11	9.52	12.13	16.73
3.6	6.14	6.56	7.71	9.88	13.77
3.7	4.94	5.28	6.22	8.01	11.25
3.8	3.97	4.24	5.01	6.47	9.15

BIBLIOGRAPHY

Molecular sulfur dioxide:

BEECH F.W. & TOMAS M^{me} S., *Bull. O.I.V.*, 1985, **58**, 564-581.

USSEGLIO-TOMASSET L. & BOSIA P.D., *F.V., O.I.V.*, 1984, n° 784.

Method OIV-MA-AS323-06

Type IV method

**Determination of mercury in wine by vapour
generation and atomic spectrofluorimeter**

(Resolution Oeno 15/2002)

1. FIELD OF APPLICATION

This method applies to the analysis of mercury in wines with a concentration range between 0 to 10 ug/l.

2. DESCRIPTION OF TECHNIQUE

2.1. Principle of the method

- 2.1.1 Mineralisation of wine takes place in an acid environment: heating under reflux; mineralisation is achieved with a potassium permanganate.
- 2.1.2. Reduction of non-consumed permanganate by hydroxylamine hydrochlorate
- 2.1.3. Reduction in mercury II (metal mercury by stannous chloride (II).
- 2.1.4. Mercury pick up by an argon current at ambient temperature
- 2.1.5. Dosage of mercury in monoatomic vapour state by atomic fluorescence spectrometre with wavelength of 254 nm. Mercury atoms are excited by a mercury vapour lamp; the atoms thus excited emit a radiation called fluorescent which allows the quantification of mercury present using a photonics detector to obtain good linearity while eliminating memory effects.

2.2 Principle of analysis (figure 1)

The peristaltic pump absorbs the stannous chloride solution, the blank solution (demineralised water containing 1% nitric acid) and the sample of mineralised wine.

The mercury metal is taken up in a gas-liquid separator by a current of argon. After going through a drying tube, the mercury is detected by fluorescence. Then, the gaseous current goes through a permanganate potassium solution in order to capture the mercury.

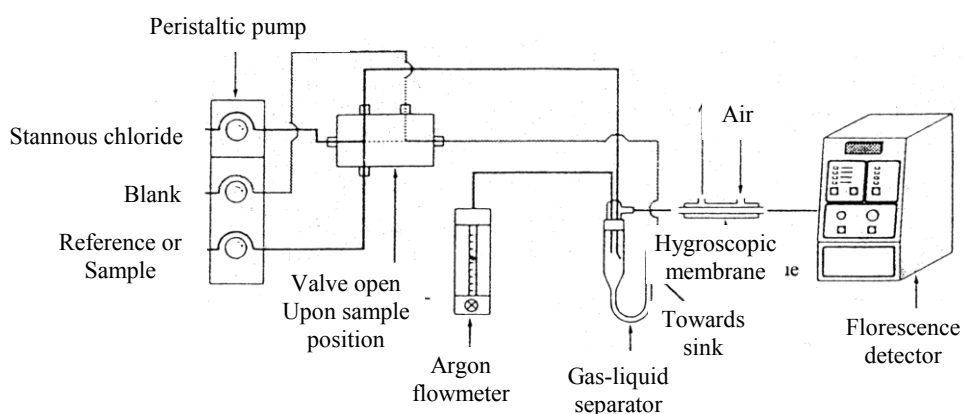

Figure n°1 Analytic Chain for dosage of mercury

3. REAGENTS AND PREPARATION OF REACTIVE SOLUTIONS

3.1 Ultra-pure demineralised water

3.2 Ultra-pure 65% nitric acid

3.3 White: demineralised water (3.1) containing 1% of nitric acid (3.2)

3.4 Nitric acid solution 5.6 M (3.1):

Put 400 ml of nitric acid (3.2) into a 1000 ml flask; fill with demineralised water (3.1).

3.5 Sulphuric acid (d= 1.84)

3.6 Sulphuric acid solution 9M:

Put 200 ml of demineralised water (3.1), 50 g of potassium permanganate (3.7) into a 1000 ml flask; fill with demineralised water (3.1).

3.7 Potassium permanganate KMnO₄

3.8 5% Potassium permanganate solution:

Dissolve 50 g of potassium permanganate (3.7) with demineralised water (3.1), in a 1000 ml flask. Fill with demineralised water (3.1).

3.9 Hydroxylamine hydrogen chloride NH₂OH, HCl

3.10 Reducing solution:

Weigh 12g of hydroxylamine hydrogen chloride (3.9) and dissolve in 100 ml of demineralised water (3.1).

3.11 Stannous chloride (SnCl₂, 2 H₂O)

3.12 Concentrated hydrochloric acid

3.13 Stannous chloride solution:

Weigh 40 g of stannous chloride (3.11) and dissolve in 50 ml of hydrochloric acid (3.12). Fill with 200 ml of demineralised water (3.1).

3.14 Mercury standard solution at 1g/l

prepared by dissolving 1708 g of Hg (NO₃). H₂O in an aqueous nitric acid solution at 12% prepared from metal mercury.

3.15 Reference mercury solution at 10 mg/l :

Place 1 ml of mercury standard solution (3.14) in a 100 ml volumetric flask, add 5 ml of nitric acid, fill with demineralised water (3.1)

3.16 Mercury solution at 50 mg/l:

Place 1 ml of 10 mg/l (3.15) solution in a 200 ml flask. Add 2 ml of nitric acid (3.2). Fill with demineralised water (3.1).

4. APPARATUS

4.1 Glass ware

4.1.1 Volumetric flasks 100, 200, and 1000 ml (class A)

4.1.2 Volumetric pipette 0.5, 1.0, 2.0, 5, 10 and 20 ml (class A)

4.1.3 *Precautionary action: Before using, the glass ware must be washed with 10% nitric acid, leave in contact 24 hours, then rinse with demineralised water.*

4.2 Mineralisation apparatus (figure 2)

4.3 Temperature controlled heating mantle

4.4 Squeeze pump

4.5 Cold vapour generator

4.5.1 Liquid gas separator

4.6 Desiccant (Hygroscopic membrane) covered by an air current (supplied from a compressor) and placed before the detector

4.7 Spectrofluorimeter

4.7.1 Mercury vapour lamp regulated to 254 nm wave length

4.7.2 Atomic fluorescence specific detector

4.8 Computer

4.8.1 Software which regulates the parameters of the vapour generator and the atomic fluorescence detector and enables calibration and usage of the results.

4.8.2 Printer which stores results

4.9 Neutral gas bottle (argon)

5. PREPARATION OF CALLIBRATION SOLUTIONS AND SAMPLES

5.1 SET OF CALLIBRATION SOLUTIONS: 0; 0.25; 0.5; and 1.0 ug/L

Introduce : 0; 0.5; and 1.0 and 2.0 ml of the mercury solution to 50 ug/l (3.16.) in 4 100 ml flasks; add 1 % nitric acid (3.2.); fill with demineralised water (3.1.).

5.2. Preparation of samples (figure 2)

Wine is mineralised in a glass pyrex apparatus made up of three parts joined by spherical honing: a 250 ml balloon, a vapour recuperation chamber, a refrigerant.

Using a pipette put 20 ml of wine in a 250 ml reaction flask; assemble the mineralisation apparatus.

Add 5 ml of sulphuric acid (3.6.) and 10 ml of nitric acid (3.4.) slowly; leave overnight.

Heat slowly under reflux until the nitrous vapours disappear ; leave to cool. Recover the condensed vapours in the reaction flask. Rinse the recipient with demineralised water. Pour the contents of the reaction flask into a 100 ml volumetric flask. Add potassium permanganate solution (3.8.) until the colour remains. Solubilize the precipitate (MnO₂) with a reducing solution (3.10.). Fill with demineralised water (3.1.).

Carry out a blank test on demineralised water.

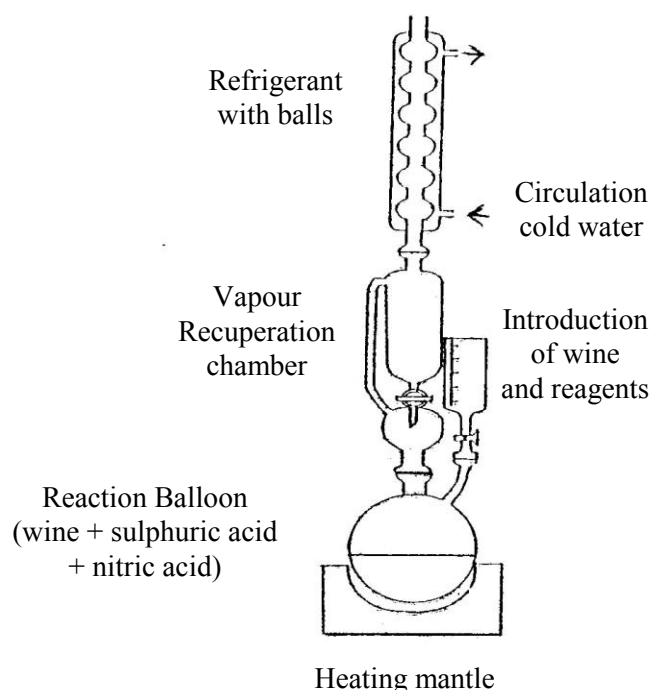

Figure n°2. Mineralisation apparatus

6. OPERATING PROCEDURE

6.1 Analytical measurement

Turn on the fluorimeter; the apparatus is stable after 15 minutes. The squeeze pump absorbs the white (3.3), the stannous lead II (3.13) and the sample calibrations (5.1) or (5.2.) Verify that bubbling occurs in the liquid gas separator. Present the calibration samples successively (5.1); set off the vapour generator program. The computer software establishes a calibration curve (percentage of fluorescence according to concentration of mercury $\mu\text{g/l}$). Then present the samples (5.2).

6.2 Automatic checks

A blank analysis and a calibration are analysed every five tests to correct any possible spectrofluorimeter derivatives.

7. EXPRESSION OF RESULTS

Results are provided by the computer software and expressed in ug/l. Deduct the mercury concentration in wine in ug/l keeping into account 1/5 dilution.

8. CHECKING RESULTS

Quality control is carried out by placing reference material in which the mercury content is known, following the set of calibrations and every 5 samples. Following the analytical series, the reference material is red wine, dry white wine or sweet white wine.

The check card is set for each reference material used. The check limits are set at: $\pm 2S_R$ intra ($2S_R$ intra : reproducibility spread-type)

The uncertainly calculation, carried out on check cards, resulted in a red wine reference of: 3.4 ± 0.8 ug/l and for reference dry white wine : 2.8 ± 0.9 ug/l.

9. BIBLIOGRAPHY

CAYROL M., BRUN S., 1975. Dosage du mercure dans les vins. Feuille Vert de l'O.I.V. n°371.

REVUELTA D., GOMEZ R., BARDON A., 1976. Dosage du mercure dans le vin par la méthode des vapeurs froides et spectrométrie d'absorption atomique. Feuille Vert de l'O.I.V. n°494.

CACHO J., CASTELLS J.E., 1989. Determination of mercury in wine by flameless atomic absorption spectrophotometry. Atomic Spectroscopy, vol. 10, n°3.

STOCKWELL P.B., CORNS W.T., 1993. The role of atomic fluorescence spectrometry in the automatic environmental monitoring of trace element analysis. Journal of Automatic Chemistry, vol. 15, n°3, p 79-84.

SANJUAN J., COSSA D., 1993. Dosage automatique du mercure total dans les organismes marins par fluorescence atomique. IFREMER, Rapport d'activité.

AFNOR, 1997. Dosage du mercure total dans les eaux par spectrométrie de fluorescence atomique. XPT 90-113-2.

GAYE J., MEDINA B., 1998. Dosage du mercure dans le vin par analyse en flux continu et spectrofluorimétrie. Feuille Vert de l'O.I.V. n°1070.

OIV-MA-AS323-07

Type of Method II

**MULTIELEMENTAL ANALYSIS USING ICP-MS
(OIV-Oeno 344-2010)**

1. SCOPE OF APPLICATION

This method can be applied to the analysis of the elements present in wines within the range indicated and featured in the following list:

- Aluminium between 0.25 and 5.0 mg/l
- Boron between 10 and 40 mg/l
- Bromine between 0.20 and 2.5 mg/l
- Cadmium between 0.001 and 0.040 mg/l
- Cobalt between 0.002 and 0.050 mg/l
- Copper between 0.10 and 2.0 mg/l
- Strontium between 0.30 and 1.0 mg/l
- Iron between 0.80 and 5.0 mg/l
- Lithium between 0.010 and 0.050 mg/l
- Magnesium between 50 and 300 mg/l
- Manganese between 0.50 and 1.5 mg/l
- Nickel between 0.010 and 0.20 mg/l
- Lead between 0.010 and 0.20 mg/l
- Rubidium between 0.50 and 1.2 mg/l
- Sodium between 5 and 30 mg/l
- Vanadium between 0.003 and 0.20 mg/l
- Zinc between 0.30 and 1.0 mg/l

**COMPENDIUM OF INTERNATIONAL ANALYSIS OF METHODS –
OIV
Multielemental analysis using ICP-MS**

This technique can also be used to analyze other elements.

The sample sometimes requires mineralization. This is the case, for example, of wines with more than 100 g/L of sugar where it can be necessary to realise mineralization of the sample before. In this case, it is recommended to perform a digestion with nitric acid in a microwave.

The technique can also be applied to musts, after mineralization.

2. BASIS

Multielemental quantitative determination using Inductively Coupled Plasma Mass Spectrometry or ICP-MS.

Injection and nebulization of the sample in high-frequency plasma. The plasma causes the desolvation, atomization and ionization of the elements in the sample. The ions are extracted using a vacuum system fitted with ionic lenses. The ions are separated according to the mass-to-charge ratio in a mass spectrometer, for example, a quadrupole. Detection and quantification of ions using an electron multiplier system.

3. REAGENTS AND SOLUTIONS

- 3.1 Ultrapure, demineralized water with resistivity ($\geq 18 \text{ M}\Omega$), in accordance with ISO 3696.
- 3.2 Certified solution(s) (for example, 100 mg/l) containing the metals to be analyzed. Multielemental or monoelemental solutions can be used.
- 3.3 Indium and/or rhodium solution as an internal standard (normally 1 g/l).
- 3.4 Nitric acid $\geq 60 \%$ (metal impurities $\leq 0.1 \mu\text{g/l}$).
- 3.5 Argon, minimum purity of 99.999%.
- 3.6 Nitrogen (maximum impurity content: $\text{H}_2\text{O} \leq 3 \text{ mg/l}$, $\text{O}_2 \leq 2 \text{ mg/l}$ and $\text{CnHm} \leq 0.5 \text{ mg/l}$).

Solution concentration and internal standards are given by way of reference.

Preparation of standard solutions:

**COMPENDIUM OF INTERNATIONAL ANALYSIS OF METHODS –
OIV
Multielemental analysis using ICP-MS**

Acid concentration in the standards and in the final dilution of the wine samples must be the same and must not exceed 5%. The following is an example.

3.7 Stock solution (5mg/l).

Place 0.5ml of solution (3.2) in a 10 ml (4.5) tube and add 0.1 ml of nitric acid (3.4). Level off to 10 ml with demineralized water (3.1) and homogenize.

Shelf life: 1 month.

3.8 Internal standard solution (1 mg/l).

Using micropipettes (4.4), place 50 µl of indium or rhodium solution (3.3) and 0.5 ml of nitric acid (3.4) in a 50 ml tube (4.6). Level off to 50 ml with demineralized water (3.1) and homogenize.

Shelf life: 1 month.

3.9 Standard solutions of the calibration curve.

Adapt the range of the series of standards according to the dilution on the sample or the equipment used.

Use 1000 µl and 100 µl pipettes (4.4).

Shelf life of standard solutions: 1 day

These standard solutions can also be prepared gravimetrically. Add internal standard in the same concentration as for the samples.

3.10 Internal control wine of known concentrations (MRC, MRE, MRI, etc.).

4. MATERIAL AND EQUIPMENT

4.1 Inductively coupled mass spectrometer with/without collision/reaction cell.

4.2 Computer with data processing software and printer.

4.3 Autosampler (optional).

4.4 1000 µl and 100 µl micropipettes.

4.5 10 ml plastic, graduated test tubes with bung or glass volumetric flasks.

4.6 50 ml plastic, graduated test tubes with bung or glass volumetric flasks.

**COMPENDIUM OF INTERNATIONAL ANALYSIS OF METHODS –
OIV
Multielemental analysis using ICP-MS**

All volumetric material (micropipettes and test tubes) must be duly calibrated.

Note: material that will come into contact with the sample, such as, for example, tubes and tips, must remain for at least 24 hours in a nitric acid solution (3.4) at a concentration of 10% and must subsequently be rinsed several times in water (3.1).

5. SAMPLE PREPARATION

Samples of sparkling wine must be degasified. This can be done through nitrogen bubbling (3.6) for 10 minutes or by using an ultrasound bath.

Remove the bung carefully to ensure that the wine is not contaminated. Wash the bottle neck in an acid solution (2% HNO₃). Wine samples are taken directly from the bottle.

Use a micropipette (4.4) to insert 0.5 ml of wine, 0.1 to 0.5 ml of nitric acid (3.4) and 100 µl of internal standard solution (3.8) into a 10 ml tube (3.5). Level off with water (3.1) and homogenize.

For certain elements a higher dilution may be necessary owing to their high natural content in the sample.

Br has high ionization potential and its ionization in plasma may be incomplete because of the presence of high concentrations of other elements in wines with low ionization potential. This may result in the incorrect quantification of Br and therefore a 1/50 dilution is recommended to avoid this effect (in the event of another dilution being used, confirm the results by checking recovery after an addition).

When the standards are prepared gravimetrically, the final dilution of the sample must also be obtained gravimetrically.

6. PROCEDURE

Switch on the device (pump working and plasma on).

Clean the system for 20 minutes using 2% nitric acid (3.4).

Check that the device is functioning correctly.

**COMPENDIUM OF INTERNATIONAL ANALYSIS OF METHODS –
OIV
Multielemental analysis using ICP-MS**

Analyze a blank and the series of standard solutions in increasing concentrations, then a standard solution (e.g. no. 2 of series 3.9) to check for correct calibration and finally the blank to ensure that there is no memory effect. Read the samples in duplicate. For the internal control, use a wine of known concentrations (3.10) to confirm that the results are coherent.

Element	m/z*
Aluminium	27
Boron	11
Bromine	79
Cadmium	114
Cobalt	59
Copper	63
Strontium	88
Iron	56/57
Lithium	7
Magnesium	24
Manganese	55
Nickel	60
Lead	average of 206, 207 and 208
Rubidium	85
Sodium	23
Vanadium	51
Zinc	64

* *The above table is given by way of example. Other isotopes may be required, depending on the equipment.*

In the event of using equipment with no collision/reaction cell, correction equations may be necessary for some elements.

7. RESULTS

**COMPENDIUM OF INTERNATIONAL ANALYSIS OF METHODS –
OIV
Multielemental analysis using ICP-MS**

The software can calculate the results directly.
Element concentrations are reported in mg/l to two decimal points.

Obtain, by interpolating in the calibration curve, the concentration of the elements in the diluted samples. Use the following equation to calculate the concentration of the elements in the sample:

$$C = \frac{C_m \times V_t}{V_m}$$

Where:

C = Concentration of the element in the sample
C_m = Concentration of the elements in the diluted sample
V_t = Final volume of the measurement solution, in ml
V_m = Aliquot volume of wine, in ml.

8. QUALITY CONTROL

Ensure traceability by using certified standards.

In each analytical series, use a CRM (Certified Reference Material) as an internal control of wine or a wine used as reference material from an interlaboratory test campaign.

It is recommended that control graphs be created from the results of the quality control analysis.

Participation in interlaboratory test campaigns.

9. PRECISION

The results of the statistical parameters of the collaborative trial are shown in Appendix A.

9.1 Repeatability (r)

**COMPENDIUM OF INTERNATIONAL ANALYSIS OF METHODS –
OIV
Multielemental analysis using ICP-MS**

The difference between two independent results, obtained using the same method, in the same sample, in the same laboratory, by the same operator, using the same equipment in a short time interval. r results are given in Tables 1 to 17 of Appendix A

9.2 Reproducibility (R)

The difference between two results, obtained using the same method, in the same sample, in a different laboratory, by a different operator and with different equipment. R results are given in Tables 1 to 17 of the Appendix A.

Table 1 represents the % of the relative standard deviation of Repeatability and Reproducibility (RSD_r% et RSD_R%) of the method. (*) C = Concentration

Element	Concentration	RSD _r %	RSD _R %
Aluminium	0,25 – 5,0 mg/l	4	10
Boron	10 - 40 mg/l	3,8	6,3
Bromine	0,20– 1,0 mg/l	4,1	16,3
	≥ 1,0 – 2,5 mg/l	2,1	8,0
Cadmium	0,001 – 0,020 mg/l	0,06 C*+0,18	10
	≥ 0,020 – 0,040 mg/l	1,5	10
Cobalt	0,002 – 0,050 mg/l	3,2	13,2
Copper	0,10 – 0,50 mg/l	3,8	11,4
	≥ 0,50 – 2,0 mg/l	2,0	11,4
Strontium	0,30 – 1,0 mg/l	2,5	7,5
Iron	0,80– 1,0 mg/l	4,2	15,7
	≥ 1,0-5,0 mg/l	4,2	7,8
Lithium	0,010 – 0,050 mg/l	7	12
Magnesium	50 - 300 mg/l	2	6
Manganese	0,50-1,5 mg/l	3	7
Nickel	0,010 – 0,20 mg/l	5	8
Lead	0,010 – 0,050 mg/l	8	7
	≥ 0,050 – 0,20 mg/l	2	7
Rubidium	0,50 – 1,2 mg/l	3	6
Sodium	5 - 10 mg/l	2	10
	≥ 10 - 30 mg/l	0,3 C*-2,5	10

**COMPENDIUM OF INTERNATIONAL ANALYSIS OF METHODS –
OIV
Multielemental analysis using ICP-MS**

Vanadium	0,003 – 0,010 mg/l	8	10
	≥ 0,010 – 0,20 mg/l	3	10
Zinc	0,30 – 1,0 mg/l	5	12

Table 1: relative standard deviation of Repeatability and Reproducibility

10. BIBLIOGRAPHY

ISO 5725:1994, *Precision of test methods-Determination of repeatability and reproducibility for a Standard test method by interlaboratory test.*

ISO 17294:2004.

ALMEIDA M. R, VASCONCELOS T, BARBASTE M. y MEDINA B. (2002), *Anal. Bioanal Chem.*, 374, 314-322.

CASTIÑEIRA *et al.* (2001), *Frenesius J. Anal. Chem.*, 370, 553-558.

DEL MAR CASTIÑEIRA GOMEZ *et al.* (2004), *J. Agric Food Chem.*, 52, 2962-2974.

MARISA C., ALMEIDA M. et VASCONCELOS T. (2003), *J. Agric. Food Chem.*, 51, 3012-3023.

MARISA *et al.*, (2003), *J. Agric Food Chem.*, 51, 4788-4798.

PÉREZ-JORDAN M. Y., SOLDEVILLA J., SALVADOR A., PASTOR A y de la GURDIA M. (1998), *J. Anat. At. Spectrom.*, 13, 33-39.

PEREZ-TRUJILLO J.-P., BARBASTE M. y MEDINA B. (2003), *Anal. Lett.*, 36(3), 679-697.

TAYLOR *et al.* (2003), *J. Agric Food Chem.*, 51, 856-860.

THIEL *et al.* (2004), *Anal. Bioanal. Chem*, 378, 1630-1636.

**COMPENDIUM OF INTERNATIONAL ANALYSIS OF METHODS –
OIV
Multielemental analysis using ICP-MS**

APPENDIX A

RESULTS OF THE COLLABORATIVE TRIALS

The method has been checked with two collaborative trials, by evaluating precision in accordance with ISO 5725. The trueness of the method has been obtained through recovery studies.

1st Collaborative Trial

8 samples (A, B, C, D, E, F, MH1 and MH2) were used from the following origins:

- Three samples of red wine, with and without addition.
- Three samples of white wine, with and without addition.
- Two samples of synthetic hydroalcoholic mixture, prepared with ethanol and water.

Hydroalcoholic sample MH1 presented problems of instability during the trial and the results have not been taken into account.

	MH2	A	B	C	D	E	F
Metal (mg/l)	Hydroalcoholic mixture	RW2	RW3	WW2	WW3	Natural red wine	Natural white wine
Aluminium	5	0.5	2	2	1	No addition	No addition
Cadmium	0.001	0.005	0.02	0.05	0.01	No addition	No addition
Strontium	0.300	No addition	No addition	No addition	No addition	No addition	No addition
Lithium	0.020	0.01	0.02	0.04	0.01	No addition	No addition
Magnesium	50	100	200	50	25	No addition	No addition
Manganese	0.500	0.5	1	1	0.5	No addition	No addition
Nickel	0.070	0.025	0.2	0.1	0.1	No addition	No addition
Lead	0.010	0.05	0.1	0.15	0.05	No addition	No addition
Rubidium	1.0	No addition	No addition	No addition	No addition	No addition	No addition
Sodium	20	10	10	20	5	No addition	No addition
Vanadium	0.010	0.05	0.2	0.1	0.1	No addition	No addition
Zinc	0.500	0.1	1	0.5	0.5	No	No

**COMPENDIUM OF INTERNATIONAL ANALYSIS OF METHODS –
OIV
Multielemental analysis using ICP-MS**

						addition	addition
--	--	--	--	--	--	----------	----------

**COMPENDIUM OF INTERNATIONAL ANALYSIS OF METHODS –
OIV
Multielemental analysis using ICP-MS**

2nd Collaborative Trial

Sixteen samples (A, B, C, D, E, F, G, H, I, J, K, L, M, N, O, P) from the following origins were used:

- Four samples of red wine, with and without addition.
- Four samples of Port wine, with and without addition.
- Six samples of white wine, with and without addition.
- Two samples of champagne.

Amounts added to the samples

Samples	Code	Addition	B	Co	Cu	Fe
			mg/l	µg/l	mg/l	Mg/l
White wine	F-N	No addition	0.0	0.0	0.0	0.0
	C-I	Addition 1	5.0	5.0	5.0	1.0
	A-O	Addition 2	10.0	10.0	1.0	2.0
Liqueur wine	B-K	No addition	0.0	0.0	0.0	0.0
	E-L	Addition 3	15.0	20.0	1.5	3.0
Red wine	D-M	No addition	0.0	0.0	0.0	0.0
	H-J	Addition 4	20.0	50.0	2.0	5.0
Sparkling wine	G-P	No addition	0.0	0.0	0.0	0.0

COMPENDIUM OF INTERNATIONAL ANALYSIS OF METHODS – OIV
Multielemental analysis using ICP-MS

PRECISION PARAMETERS (Tables 1 to 17):

The values of $Horrat_r$ and $Horrat_R$ have been obtained by using the Horwitz equation taking into account Thompson's modification for the concentration below 120 µg/L.

Table 1: Aluminium (mg/l)

SAMPLE	LAB. No.	Accepted	Vréf	Sr	r	RSD _r (%)	Horwitz RSD _r (%)	Horrat _r	SR	R	RSD _R (%)	Horwitz RSD _R (%)	Horrat _R
A	11	10	0,68	0,020	0,06	2,9	11	0,26	0,077	0,22	11	17	0,66
B	11	9	2,1	0,043	0,12	2,0	9,4	0,22	0,21	0,61	10	14	0,71
C	11	9	2,1	0,032	0,09	1,5	9,5	0,16	0,21	0,59	10	14	0,69
D	11	10	1,2	0,041	0,12	3,4	10	0,34	0,10	0,29	8,3	16	0,56
E	11	10	0,34	0,014	0,04	4,1	12	0,34	0,029	0,08	8,5	19	0,46
F	11	10	0,27	0,006	0,02	2,2	13	0,17	0,028	0,08	10	20	0,52
MH2	11	8	5,2	0,26	0,73	5,0	8,2	0,60	0,56	1,6	11	13	0,86

COMPENDIUM OF INTERNATIONAL ANALYSIS OF METHODS – OIV
Multielemental analysis using ICP-MS

Table 2: Boron (mg/l)

SAMPLE:	LAB. No.	Accepted	Vréf	Sr	r	RSD_r (%)	Horwitz RSD_r (%)	Horrat_r	SR	R	RSD_R (%)	Horwitz RSD_R (%)	Horrat_R
A-O	8	6	18	0,77	2,2	4,3	6,8	0,62	0,94	2,69	5,2	10	0,50
B-K	8	4	4,5	0,27	0,76	6,0	8,4	0,72	0,40	1,14	8,9	13	0,70
C-I	8	4	13	0,31	0,89	2,4	7,2	0,33	0,33	0,94	2,5	11	0,24
D-M	8	7	11	0,26	0,74	2,4	7,4	0,31	1,1	3,11	10	11	0,90
E-L	8	5	21	0,47	1,3	2,2	6,7	0,33	0,85	2,43	4,0	10	0,40
F-N	8	5	8,3	0,43	1,2	5,2	7,7	0,68	0,47	1,34	5,7	12	0,48
G-P	7	4	3,1	0,094	0,27	3,0	8,9	0,34	0,18	0,51	5,8	14	0,43
H-J	8	5	31	1,0	3,0	3,2	6,3	0,54	1,6	4,43	5,2	9,6	0,52

COMPENDIUM OF INTERNATIONAL ANALYSIS OF METHODS – OIV
Multielemental analysis using ICP-MS

Table 3: Bromine (mg/l)

SAMPLE:	LAB. No.	Accepted	Vref	Sr	r	RSD_r (%)	Horwitz RSD_r (%)	Horrat_r	SR	R	RSD_R (%)	Horwitz RSD_R (%)	Horrat_R
A-O	6	2	1,21	0,028	0,08	2,3	10,3	0,22	0,041	0,12	3,4	15,6	0,22
B-K	5	2	0,19	0,006	0,02	2,9	13,6	0,21	0,0043	0,012	2,3	20,5	0,11
C-I	6	3	0,81	0,017	0,05	2,1	10,9	0,19	0,062	0,18	7,7	16,5	0,47
D-M	6	4	0,38	0,017	0,05	4,5	12,2	0,37	0,066	0,19	17,4	18,5	0,94
E-L	6	3	1,72	0,030	0,09	1,7	9,7	0,17	0,22	0,62	12,8	14,8	0,86
F-N	6	3	0,22	0,014	0,04	6,4	13,3	0,48	0,046	0,13	20,9	20,1	1
H-J	6	2	2,30	0,061	0,17	2,7	9,3	0,28	0,092	0,26	4	14,1	0,28

COMPENDIUM OF INTERNATIONAL ANALYSIS OF METHODS – OIV
Multielemental analysis using ICP-MS

Table 4: Cadmium ($\mu\text{g/l}$)

SAMPLE:	LAB. No.	Accepted	Vréf	Sr	r	RSD_r (%)	Horwitz RSD_r (%)	Horrat_r	SR	R	RSD_R (%)	Horwitz RSD_R (%)	Horrat_R
A	12	11	6	0,2	0,6	3,3	15	0,22	1	3	17	22	0,77
B	12	11	16	0,4	1	2,5	15	0,17	2	6	13	22	0,59
C	12	9	40	0,4	1	1,0	15	0,07	3	8	7,5	22	0,34
D	12	10	10	0,3	0,8	3,0	15	0,20	0,9	3	9,0	22	0,41
E	8	7	0,3	0,20	0,6	67	15	4,47	0,20	0,67	67	22	3,05
F	8	6	0,3	0,04	0,1	13	15	0,87	0,20	0,45	67	22	3,05
MH2	9	5	0,9	0,08	0,2	8,9	15	0,59	0,10	0,29	11	22	0,50

COMPENDIUM OF INTERNATIONAL ANALYSIS OF METHODS – OIV
Multielemental analysis using ICP-MS

Table 5: Cobalt (µg/l)

SAMPLE:	LAB. No.	Accepted	Vréf	Sr	r	RSD_r (%)	Horwitz RSD_r (%)	Horrat_r	SR	R	RSD_R (%)	Horwitz RSD_R (%)	Horrat_R
A-O	10	6	22	0,5	1	2,3	15	0,15	2	6	9,1	22	0,41
B-K	10	6	8	0,3	0,9	3,8	15	0,25	1	4	13	22	0,59
C-I	10	8	19	0,4	1	2,1	15	0,14	3	7	16	22	0,73
D-M	10	3	3	0,07	0,2	2,3	15	0,15	0,1	0,3	3,3	22	0,15
E-L	10	8	27	1	3	3,7	15	0,25	3	9	11	22	0,50
F-N	10	7	12	0,5	2	4,2	15	0,28	1	4	8,3	22	0,38
G-P	9	5	2	0,2	0,5	10	15	0,67	0,3	0,8	15	22	0,68
H-J	10	6	49	0,5	1	2,3	15	0,15	6	18	12	22	0,55

COMPENDIUM OF INTERNATIONAL ANALYSIS OF METHODS – OIV
Multielemental analysis using ICP-MS

Table 6: Copper (mg/l)

SAMPLE	LAB. No.	Accepted	Vréf	Sr	r	RSD_r (%)	Horwitz RSD_r (%)	Horrat_r	SR	R	RSD_R (%)	Horwitz RSD_R (%)	Horrat_R
A-O	10	8	1,1	0,013	0,040	1,2	10	0,12	0,11	0,32	10	16	0,63
B-K	10	8	0,21	0,006	0,020	2,9	13	0,22	0,021	0,060	10	20	0,50
C-I	10	7	0,74	0,009	0,030	1,2	10	0,12	0,046	0,13	6,2	17	0,36
D-M	10	8	0,14	0,007	0,020	5,0	14	0,36	0,015	0,043	11	22	0,50
E-L	10	9	1,7	0,061	0,17	3,6	7,8	0,5	0,16	0,46	9,0	15	0,60
F-N	10	7	0,16	0,006	0,020	3,8	14	0,27	0,029	0,083	18	21	0,86
G-P	9	4	0,042	0,004	0,010	9,5	15	0,63	0,006	0,017	14	22	0,64
H-J	10	7	2,1	0,018	0,050	0,86	9,5	0,09	0,24	0,69	11	14	0,79

COMPENDIUM OF INTERNATIONAL ANALYSIS OF METHODS – OIV
Multielemental analysis using ICP-MS

Table 7: Strontium (µg/l)

SAMPLE	LAB. N°	Accepted	Vréf	Sr	r	RSD_r (%)	Horwitz RSD_r (%)	Horrat_r	SR	R	RSD_R (%)	Horwitz_R RSD_R (%)	Horrat_R
A	12	11	1091	33	93	3,0	10	0,30	78	222	7,2	16	0,45
B	12	8	1139	66	188	5,8	10	0,58	69	195	6,1	16	0,38
C	12	9	328	6	18	1,8	13	0,14	19	54	5,8	19	0,31
D	12	10	313	7	20	2,2	13	0,17	22	61	7,0	19	0,37
E	12	10	1176	28	80	2,4	10	0,24	86	243	7,3	16	0,46
F	12	10	293	3	9	1,0	13	0,08	22	62	7,5	19	0,39
MH2	12	9	352	7	19	2,0	12	0,17	24	69	6,8	19	0,36

COMPENDIUM OF INTERNATIONAL ANALYSIS OF METHODS – OIV
Multielemental analysis using ICP-MS

Table 8: Iron (mg/l)

SAMPLE	LAB. No.	Accepted	Vréf	Sr	r	RSD_r (%)	Horwitz RSD_r (%)	Horrat_r	SR	R	RSD_R (%)	Horwitz RSD_R (%)	Horrat_R
A-O	10	6	3,2	0,017	0,05	0,53	8,9	0,06	0,23	0,66	7,2	13	0,55
B-K	10	6	1,5	0,085	0,24	5,7	9,9	0,58	0,11	0,31	7,3	15	0,49
C-I	10	5	2,1	0,036	0,10	1,7	9,4	0,18	0,18	0,51	8,6	14	0,61
D-M	10	5	3,1	0,033	0,094	1,1	8,9	0,12	0,29	0,83	9,4	14	0,67
E-L	10	5	4,3	0,120	0,34	2,8	8,5	0,33	0,29	0,83	6,7	13	0,52
F-N	10	6	1,1	0,051	0,15	4,6	10	0,46	0,16	0,46	15	16	0,94
G-P	9	6	0,83	0,024	0,07	2,9	11	0,26	0,14	0,40	17	16	1,06
H-J	10	7	7,8	0,180	0,52	2,3	7,8	0,29	1,2	3,52	15	12	1,25

COMPENDIUM OF INTERNATIONAL ANALYSIS OF METHODS – OIV
Multielemental analysis using ICP-MS

Table 9: Lithium ($\mu\text{g/l}$)

SAMPLE	LAB. No.	Accepted	Vr_{éf}	Sr	r	RSD_r (%)	Horwitz RSD_r (%)	Horrat_r	SR	R	RSD_R (%)	Horwitz_R RSD_R (%)	Horrat_R
A	11	10	34	2	5	5,9	15	0,39	4	11	11	22	0,50
B	11	11	42	3	8	7,1	15	0,47	4	12	10	22	0,45
C	11	11	47	1	4	2,1	15	0,14	5	13	9,8	22	0,45
D	11	11	18	1	4	5,6	15	0,37	2	7	14	22	0,64
E	11	11	25	1	3	4,0	15	0,27	3	9	12	22	0,55
F	11	9	9	0,3	1	3,8	15	0,25	0,6	2	7,2	22	0,33
MH2	11	7	22	1	3	4,6	15	0,31	1	3	5,3	22	0,24

COMPENDIUM OF INTERNATIONAL ANALYSIS OF METHODS – OIV
Multielemental analysis using ICP-MS

Table 10: Magnesium (mg/l)

SAMPLE:	LAB · No.	Accepted	Vr_{éf}	Sr	r	RSD_r (%)	Horwitz RSD_r (%)	Horrat_r	SR	R	RSD_R (%)	Horwitz RSD_R (%)	Horrat_R
A	10	7	182	2,9	8,1	1,6	4,3	0,37	9,3	26	5,1	7,3	0,70
B	10	6	280	3,9	11	1,4	4,5	0,31	6,0	17	2,1	6,9	0,30
C	10	7	104	2,4	6,9	2,3	5,3	0,43	6,8	19,25	6,5	8,0	0,81
D	10	6	85	1,4	4,0	1,7	5,4	0,31	2,2	6,1	2,6	8,2	0,32
E	10	7	94	2,2	6,2	2,3	5,3	0,43	5,5	16	5,9	8,1	0,73
F	10	7	65	0,95	2,7	1,5	5,6	0,27	3,8	11	5,9	8,5	0,69
MH2	10	7	51	0,90	2,5	1,8	5,8	0,31	2,4	6,9	4,7	8,9	0,53

COMPENDIUM OF INTERNATIONAL ANALYSIS OF METHODS – OIV
Multielemental analysis using ICP-MS

Table 11: Manganese (mg/l)

SAMPLE	LAB. No.	Accepted	Vr_{éf}	Sr	r	RSD_r (%)	Horwitz RSD_r (%)	Horrat_r	SR	R	RSD_R (%)	Horwitz_R RSD_R (%)	Horrat_R
A	11	10	1,3	0,014	0,040	1,1	10	0,11	0,13	0,37	10	15	0,67
B	11	9	1,8	0,14	0,40	7,8	9,7	0,80	0,20	0,56	11	15	0,73
C	11	8	1,5	0,028	0,080	1,9	9,9	0,19	0,084	0,24	5,6	15	0,37
D	11	8	1,0	0,035	0,10	3,5	11	0,32	0,049	0,14	4,9	16	0,31
E	11	9	0,84	0,019	0,050	2,3	11	0,21	0,057	0,16	6,8	16	0,43
F	11	9	0,59	0,015	0,040	2,5	11	0,23	0,031	0,090	5,3	17	0,31
MH2	11	8	0,52	0,029	0,080	5,6	12	0,47	0,037	0,10	7,1	18	0,39

COMPENDIUM OF INTERNATIONAL ANALYSIS OF METHODS – OIV
Multielemental analysis using ICP-MS

Table 12: Nickel (µg/l)

SAMPLE	LAB. No.	Accepted	Vr_{éf}	Sr	r	RSD_r (%)	Horwitz RSD_r (%)	Horrat_r	SR	R	RSD_R (%)	Horwitz_R RSD_R (%)	Horrat_R
A	11	10	40	2	6	5,0	15	0,33	5	13,90	13	22	0,59
B	12	10	194	7	20	3,6	14	0,26	17	48,96	8,8	21	0,42
C	12	8	148	4	10	2,7	14	0,19	5	15,12	3,4	21	0,16
D	12	8	157	4	12	2,6	14	0,19	8	23,10	5,1	21	0,24
E	11	8	15	0,6	2	4,0	15	0,27	1	3,33	6,7	22	0,30
F	12	9	66	1	4	1,5	15	0,10	4	10,58	6,1	22	0,28
MH2	11	7	71	5	14	7,0	15	0,47	4	11,41	5,6	22	0,25

COMPENDIUM OF INTERNATIONAL ANALYSIS OF METHODS – OIV
Multielemental analysis using ICP-MS

Table 13: Lead ($\mu\text{g/l}$)

SAMPLE	LAB. No.	Accepted	Vr_{éf}	Sr	r	RSD_r (%)	Horwitz RSD_r (%)	Horrat_r	SR	R	RSD_R (%)	Horwitz_R RSD_R (%)	Horrat_R
A	12	9	59	1	4	1,7	15	0,11	3	9	5,1	22	0,23
B	12	10	109	2	6	1,8	15	0,12	8	23	7,3	22	0,33
C	12	9	136	3	9	2,2	14	0,16	13	37	9,6	22	0,44
D	12	9	119	2	6	1,7	15	0,11	5	13	4,2	22	0,19
E	12	10	13	1	3	7,7	15	0,51	1	4	7,7	22	0,35
F	12	9	92	1	4	1,1	15	0,07	4	11	4,4	22	0,20
MH2	12	10	13	1	3	7,7	15	0,51	1	3	7,7	22	0,35

COMPENDIUM OF INTERNATIONAL ANALYSIS OF METHODS – OIV
Multielemental analysis using ICP-MS

Table 14: Rubidium ($\mu\text{g/l}$)

SAMPLE	LAB. No.	Accepted	Vr_{éf}	Sr	r	RSD_r (%)	Horwitz RSD_r (%)	Horrat_r	SR	R	RSD_R (%)	Horwitz_R RSD_R (%)	Horrat_R
A	11	6	717	14	41	2,0	11	0,18	13	36	1,8	17	0,11
B	11	7	799	25	70	3,1	11	0,28	30	86	3,8	17	0,22
C	11	8	677	10	27	1,5	11	0,14	34	96	5,0	17	0,29
D	11	7	612	18	51	2,9	11	0,26	18	50	2,9	17	0,17
E	11	9	741	19	53	2,6	11	0,24	66	187	8,9	17	0,52
F	11	9	617	10	28	1,6	11	0,15	43	123	7,0	17	0,41
MH2	11	7	1128	10	28	0,89	10	0,09	64	181	5,7	16	0,36

COMPENDIUM OF INTERNATIONAL ANALYSIS OF METHODS – OIV
Multielemental analysis using ICP-MS

Table 15: Sodium (mg/l)

SAMPLE	LAB. No.	Accepted	Vr_{éf}	S_r	r	RSD_r (%)	Horwitz RSD_r (%)	Horrat_r	SR	R	RSD_R (%)	Horwitz_R RSD_R (%)	Horrat_R
A	10	9	19	0,59	1,7	3,1	6,8	0,46	2,2	5,7	12	10	1,20
B	10	9	20	1,3	3,6	6,5	6,7	0,97	2,2	6,3	11	10	1,10
C	10	7	28	0,33	0,93	1,2	6,4	0,19	1,9	5,4	6,8	9,7	0,70
D	10	8	11	0,24	0,68	2,2	7,4	0,30	1,1	3,0	10	11	0,91
E	10	8	9,8	0,19	0,53	1,9	7,5	0,25	0,89	2,5	9,1	11	0,83
F	10	8	6,1	0,093	0,26	1,5	8,1	0,19	0,74	2,1	12	12	1,00
MH2	10	8	24	1,8	5,0	7,5	6,6	1,14	2,6	7,2	11	9,9	1,11

COMPENDIUM OF INTERNATIONAL ANALYSIS OF METHODS – OIV
Multielemental analysis using ICP-MS

Table 16: Vanadium (µg/l)

SAMPLE	LAB. No.	Accepted	Vr_{éf}	Sr	r	RSD_r (%)	Horwitz RSD_r (%)	Horrat_r	SR	R	RSD_R (%)	Horwitz_R RSD_R (%)	Horrat_R
A	12	11	46	1	3	2,2	15	0,15	5	13	11	22	0,50
B	12	11	167	5	15	3,0	14	0,21	19	54	11	21	0,52
C	12	11	93	3	8	3,2	15	0,21	12	33	13	22	0,59
D	12	9	96	3	8	3,1	15	0,21	8	22	8,3	22	0,38
E	10	7	3	0,2	0,7	6,7	15	0,45	0,3	0,9	10	22	0,45
F	10	8	3	0,2	0,6	6,7	15	0,45	0,2	0,7	6,7	22	0,30
MH2	12	9	11	0,3	1	2,7	15	0,18	0,9	3	8,2	22	0,37

COMPENDIUM OF INTERNATIONAL ANALYSIS OF METHODS – OIV
Multielemental analysis using ICP-MS

Table 17: Zinc (µg/l)

SAMPLE	LAB. No.	Accepted	Vr_{éf}	Sr	r	RSD_r (%)	Horwitz RSD_r (%)	Horrat_r	SR	R	RSD_R (%)	Horwitz_R RSD_R (%)	Horrat_R
A	11	8	405	22	61	5,4	12	0,45	45	128	11	18	0,61
B	11	9	1327	49	138	3,7	10	0,37	152	429	11	15	0,73
C	11	9	990	14	41	1,4	11	0,13	86	243	8,7	16	0,54
D	11	9	1002	28	79	2,8	11	0,25	110	310	11	16	0,69
E	11	9	328	13	37	4,0	13	0,31	79	224	24	19	1,26
F	11	9	539	15	42	2,8	12	0,23	61	172	11	18	0,61
MH2	11	8	604	72	204	12	11	1,09	89	251	15	17	0,88

Method OIV-MA-AS323-08

Method type II

Assay of pesticide residues in wine following extraction using
the Quechers method

(Résolution Oeno 436/2012)

1. INTRODUCTION

Several reference documents were used in the preparation of this analysis method, which has been validated by a laboratory [1] [2].

2 -SCOPE

This method defines the steps involved in extracting pesticide residues in wine using the QuEChERS method (*Quick Easy Cheap Effective Rugged and Safe*) and the analysis of the extracts obtained by GC/MS and/or LC/MS-MS.

3 -PRINCIPLE

The sample is extracted using acetonitrile, followed by liquid-liquid partitioning induced by adding magnesium sulphate and sodium chloride and buffering with citrate salts. The extract is then purified using an amino adsorbent (dispersive SPE with APS and magnesium sulphate). To improve their stability during storage, the extracts are acidified by adding a small quantity of formic acid. The final extract may be used directly in the determination by GC/MS and LC/MS-MS. For analyses by LC/MS-MS only, the dispersive SPE is not essential.

4. REAGENTS AND MATERIALS

4.1. General points and safety issues

Pesticides are potentially toxic, and safe handling practices must be implemented to protect the analysts, notably when preparing the stock solutions from commercially-available active ingredients.

Take all necessary precautions to prevent pesticide contamination of water, solvents, and other products.

Unless otherwise specified, the reagents used shall be of recognised analytical quality.

4.2 Water, HPLC quality

4.3 Acetonitrile [75-05-8] HPLC quality

4.4 Methanol [67-56-1], HPLC quality

4.5 Magnesium sulphate anhydrous [7487-88-9], particles

4.6 Magnesium sulphate, anhydrous [7487-88-9], fine powder

4.7 Sodium chloride [7647-14-5]

4.8 Disodium hydrogen citrate, sesquihydrate [6132-05-4]

4.9 Trisodium citrate dihydrate [6132-04-3]

4.10 Mixture of buffer salts for the extraction step:

Weigh 4 g of anhydrous magnesium sulphate in particle form, 1 g of sodium chloride, 1 g of trisodium citrate dihydrate and 0.5 g of disodium hydrogen citrate sesquihydrate and place these reagents in a flask. The prior mixing of salts avoids the formation of crystals.

4.11 Formic acid solution in acetonitrile

Dilute 0.5 mL of formic acid up to a volume of 10 mL with acetonitrile.

4.12 Primary and secondary amine (PSA) adsorbent

For exemple, Bondesil-PSA® 40 µm Varian N° 12213023 1

4.13 Internal standard solutions and quality-control standard solutions

Several compounds may be used as internal standards: for example triphenylphosphate [115-86-6] and triphenylmethane [519-73-3].

Use a quality control standard to indicate the extraction efficiency of the residues from the samples: for example tris(1,3dichloroisopropyl)phosphate or TCPP.

Solutions of a suitable concentration should be prepared.

Example: preparing the TCPD solution at 10mg/L

Place 1 mL of stock solution containing 500 mg/L of tris(1,3-dichloroisopropyl)phosphate in a 50 mL volumetric flask and make up to volume with acetonitrile.

4.14 Calibration ranges; standard solutions containing different active ingredients

4.14.1 Standard stock solutions

Prepare stock solutions with a concentration of active ingredients of 500 mg/l in a suitable solvent (acetone for example).

Store at -18°C.

4.14.2 Surrogate solutions

A mixture of active ingredients selected to suit the equipment used (GC or LC) and to satisfy calibration range restrictions.

4.14.3 Calibration range

Standard solutions in acetonitrile

A calibration range is prepared from surrogate solutions with the objective of obtaining a calibration line from 20 to 500 µg/l.

Standard solutions in a wine matrix

From a wine that does not contain any active ingredients, a blank matrix is prepared in accordance with protocol 6.1.1, then supplemented with increasing quantities of active ingredients in order to produce a calibration line from 20 to 500 µg/l.

5. Equipment

5.2. Glassware and volumetric laboratory equipment:

5.2.1. 100 mL stoppered flasks

5.2.2. 50 mL and 12 mL single-use centrifuge tubes with screw-on stoppers

5.2.3. 10 mL class A graduated test tubes

5.2.4. 10 mL, 50 mL and 100 mL class A volumetric flasks

5.2.5. Piston-operated volumetric apparatus with delivered volumes ranging from 30 µl to 1,000 µl, checked in accordance with ISO 8655-6

5.2.6. 2 mL sampling syringes

5.3. Nylon microfilters with a pore size of 0.45 µm

5.4. Analytical balance

5.5. High-speed mixing device (such as a Vortex mixer)

5.6. Centrifuge for 50 mL and 12 mL tubes, capable of generating 3,000 g.

5.7. LC/MS-MS system, with an electrospray ionisation interface.

5.8. GC/MS system, fitted with suitable injection and detection devices (for example ion trap or triple quadrupole).

6. PROCEDURE

6.1. Preparing the samples.

6.1.1. Extraction using the QuEChERS method

Place 10 g or measure 10 mL of the sample (wine) into a centrifuge tube and add 10 mL of acetonitrile and 100 µL of a 10 mg/L solution of tris(1,3-dichloroisopropyl)phosphate. Shake vigorously for 1 minute. Pour the mixture of salts (4.10) into the centrifuge tube containing the liquid mixture.

Shake vigorously for 1 minute. Centrifuge for 5 minutes at 3,000 g.

Filter approximately 1 mL of the solution through Nylon 25 mm/45 µm filters in preparation for the LC-MS analysis.

6.1.2. Purifying the extract using an amino adsorbent (“dispersive SPE” with APS)

Place 6 mL of the acetonitrile phase described in 6.1.1. in a centrifuge tube containing 900 mg of magnesium sulphate in the form of a fine powder (4.6) and 150 mg of APS (4.12). Stopper the tube and shake vigorously for 30 s, then

centrifuge for 5 min at 3,000 g. Without pausing, isolate and acidify the extract purified in this way by adding 50 µl of formic acid solution (4.11).

The GC-MS analysis can then be performed.

NOTE: to minimise matrix effects, a solution of “protectant” agents can be added to the sample extracts and the calibration solutions [3]

To prepare a 10 mL solution of “protectant” agents:

Weigh out 15 mg of sorbitol, 300 mg of ethylglycerol and 100 mg of gluconolactone,

Add 2mL of water

Make up to 10 mL with acetonitrile.

20 µl of this solution is added to each flask containing the calibration solutions (1 mL) and sample extracts (1 mL).

6.2. Results and Calculations

6.2.1. Identification of the residues

The residues are identified by considering certain parameters:

- their retention time
- their mass spectrum
- the relative abundance of the ion fragments (it is advisable to operate with 1 or 2 MS/MS transitions and 2 or 3 ions in MS).

6.2.2. Quantification

The extracts obtained in 6.1.1 and 6.1.2 can be analysed using various instruments, parameters and columns. However, the conditions should be adapted for each compound depending on the instruments used in order to obtain the best sensitivities.

Use the standard solutions to prepare a 5-point calibration range to check the linearity for each active ingredient.

The concentration in mg/kg (or mg/L) for each substance identified is obtained directly from the calibration line.

6.2.3. Extraction efficiency

The extraction efficiency can be checked by adding a quality-control standard to the samples, TCPF for example (see 6.1.1).

The efficiency must be between 70 and 120%.

The efficiency results are not taken into consideration when correcting the levels of residues in wines, but do allow validation of the procedure.

7. RELIABILITY OF THE METHOD

The results of the validation carried out in accordance with MA-F-AS1-08-FIDMET [4] and MA-F-AS1-09-PROPER [5], are indicated in the table below. The average recovery rates are between 70% and 120% (the spiking levels covered a concentration range from 0.020 mg/L to 0.200 mg/L)

7.1 Repeatability (expressed in $CV_r\%$)

Repeatability (expressed as $CV_r\%$) is on average equal to 10%.

7.2 Reproducibility (expressed in $CV_R\%$)

Reproducibility (expressed as $CV_R\%$) is on average equal to 30%.

COMPENDIUM OF INTERNATIONAL METHODS OF ANALYSIS - OIV
Assay of pesticide residues in wine following extraction using
the Quechers method

	Recovery rate %.	CV _r %	CV _R %	HorRat
Metalaxyl	89	7	26	1.1
Chlorpyrifos ethyl	81	13	23	1.0
Tebuconazole	99	9	32	1.3
Cyprodinil	93	9	29	1.1
Tebufenozide	102	11	28	1.2
Fludioxonil	101	7	40	1.4
Benalaxyl	98	9	29	1.1
Cyproconazole	92	11	31	1.3
Tebufenpyrad	95	10	31	1.2
Pyraclostrobin	116	6	29	1.2
Vinclozolin	84	9	28	1.1
Mepanipyrim	82	11	30	1.1
Boscalid	95	7	28	1.1
Iprovalicarb	106	7	33	1.2
Iprodione	108	10	27	1.1
Procymidone	100	11	34	1.2
Pyrimethanil	75	12	27	1.0
Carbendazim	113	11	41	1.6
Fenbuconazole	94	6	48	2.0
Fenitrothion	90	13	36	0.7
Metrafenone	93	8	19	0.7
Penconazole	109	8	35	1.1
Flusilazole	93	8	37	1.3
Oxadixyl	86	8	37	1.3
Azoxystrobin	84	8	30	1.2
Dimethomorph	90	9	36	1.4
Fenhexamid	87	8	22	0.8

All results from inter-laboratory tests that have been conducted on reliability data are presented in **Appendix A**

8. BIBLIOGRAPHY

[1] P. Paya. J. Oliva. A. Barba. M. Anastassiades. D. Mack. I. Sigalova. B. Tasdelen; “Analysis of pesticides residues using the Quick Easy Cheap Affective Rugged and Safe (QuEChERS) pesticide multiresidue method in combination with gas and liquid chromatography and tandem mass spectroscopy detection”. *Anal Bioanal Chem.* 2007.

[2] EN 15662: 2008 – Foods of plant origin - Determination of pesticide residues using GC-MS and/or LC-MS/MS following acetonitrile extraction/partitioning and clean-up by dispersive SPE – QuEChERS method; January 2009; AFNOR

[3]K. Mastovska. Steven J. Lehotay. and M. Anastassiades; “Combination of analyte protectants to overcome matrix effects in routine GC analysis of pesticides residues in food matrixes”. *Anal. Chem.* 2005. 77. 8129-8137.

[4]MA-F-AS1-08-FIDMET. OIV: Reliability of Analytical Methods (resolution oeno 5/99).

[5]MA-F-AS1-09-PROPER. OIV: Protocol for the planning, performance and interpretation of performance studies pertaining to methods of analysis (resolution 6/2000).

FV 1410: Results of the inter-laboratory study

COMPENDIUM OF INTERNATIONAL METHODS OF ANALYSIS - OIV
Assay of pesticide residues in wine following extraction using
the Quechers method

APPENDIX A

RESULTS OF THE RELIABILITY STUDY

This document presents the results of the validation study on the method of assay of pesticide residues in wine following extraction using QuEChERS (FV 1340).

The study was performed in accordance with the OIV documents MA-F-AS1-08-FIDMET and MA-F-AS1-09-PROPER

1 - Participating laboratories

Sixteen laboratories took part in the study:

LABORATOIRE INTER RHONE	France
INSTITUT FUR HYGIENE UND UMWELT	Germany
LABORATORIO AGROENOLÓGICO UNIVERSIDAD CATÓLICA DEL MAULE	Chile
AGRICULTURAL OFFICE OF BORSOD-ABAUJ-ZEMPLEN COUNTY	Hungary
PESTICIDE RESIDUE ANALYTICAL LABORATORY	Hungary
AUSTRIAN AGENCY FOR HEALTH AND FOOD SAFETY	Austria
COMPETENCE CENTER FOR PLANT PROTECTION PRODUCTS	Austria
LABORATOIRE DEPARTEMENTAL DE LA SARTHE	France
LABORATOIRE PHYTOCONTROL	France
BENAKI PHYTOPATHOLOGICAL INST. PESTICIDES RESIDUES LAB.	Greece
LABORATOIRE DUBERNET OENOLOGIE	France
ARPAL DIPARTIMENTO LA SPEZIA	Italy
ARPA VENETO – SERVIZIO LABORATORI VERONA	Italy
ARPALAZIO – SEZIONE DI LATINA	Italy
ANALAB CHILE S.A.	Chile
LABORATORIO REGIONAL DE LA CCAA DE LA RIOJA	Spain
SCL LABORATOIRE DE BORDEAUX	France
ARPA – FVG DIP. DI PORDENONE	Italy

COMPENDIUM OF INTERNATIONAL METHODS OF ANALYSIS - OIV
Assay of pesticide residues in wine following extraction using
the Quechers method

2 - Samples - Active ingredients analysed

For this study, 12 samples were proposed:

- four red wines: A. B. G. H
- four white wines: C. D. I. J
- two port wines: E. K
- two muscat wines: F. L

The 27 active substances were determined across the 12 samples covering a concentration range of 0.015 mg/L to 0.200 mg/L (see table below).

	A – G <i>mg/L</i>	B – H <i>mg/L</i>	C – I <i>mg/L</i>	D – J <i>mg/L</i>	E – K <i>mg/L</i>	F – L <i>mg/L</i>
Metalaxyl	0.050	0.040	0.100	0.020		
Chlorpyrifos ethyl	0.100	0.040	0.200	0.020		
Tebuconazole	0.025	0.080	0.050	0.040		
Cyprodinil	0.050	0.040	0.100	0.020		
Tebufenozide	0.050		0.100			
Fludioxonil	0.025		0.050			
Benalaxyl	0.052	0.041	0.104	0.021		
Cyproconazole	0.054	0.086	0.108	0.043		
Tebufenpyrad	0.050	0.040	0.100	0.020		
Pyraclostrobin	0.050		0.100			
Vinclozolin		0.040		0.020	0.050	0.100
Mepanipyrim		0.080		0.040	0.025	0.050
Boscalid		0.080		0.040	0.100	0.200
Iprovalicarb					0.050	0.100
Iprodione		0.076		0.038	0.047	0.094
Procymidone		0.020		0.010		
Pyrimethanil		0.040		0.020		
Carbendazim				0.054		0.027
Fenbuconazole		0.080		0.040		

COMPENDIUM OF INTERNATIONAL METHODS OF ANALYSIS - OIV
Assay of pesticide residues in wine following extraction using
the Quechers method

Fenitrothion		0.040		0.020		
Metrafenone		0.040		0.020		
Penconazole		0.016		0.008		
Flusilazole		0.040		0.020		
Oxadixyl	0.050				0.025	
Azoxystrobin	0.100				0.050	
Dimethomorph	0.100				0.050	
Fenhexamid	0.100				0.050	

4 - Statistical assessment

All raw results are presented in FV 1410.

In each table, eliminated or nonsensical values appear in a different font.

4.1 Eliminated values

Some values are eliminated before evaluation in the following cases:

- to evaluate the repeatability of the method we have used the principle of double-blind samples: some laboratories only gave a single result on paired samples. this value was eliminated (noted in the tables as “**xxx**”)
- when the results are expressed in the format "less than" (noted in the tables as “**xxx**”)

The COCHRAN and GRUBBS tests were successively applied to paired samples to eliminate abnormal variances on the one hand and abnormal extreme average values on the other. The values eliminated by both these tests appear in the tables as “**xxx**”.

4.2 Repeatability - Reproducibility

The repeatability and reproducibility parameters are grouped in **Table 1**.

In this table the following items are indicated for each substance:

- n: number of tests selected
- average: results average

COMPENDIUM OF INTERNATIONAL METHODS OF ANALYSIS - OIV
Assay of pesticide residues in wine following extraction using
the Quechers method

- TR%: average recovery rate
- CVr%: repeatability as a % of the average
- CV_R%: reproducibility as a % of the average
- PR CV_R%: reproducibility as a % calculated using the Horwitz equation (PR CV% = $2C^{-0.1505}$)
- HoR : HorRaT value (CV_R% / PR CV_R%)

The evaluation criteria selected are:

- recovery rate between 70% and 120%
- the results obtained under reproducibility conditions are compared to those predicted according to the Horwitz model using the HorRat value. Reproducibility values are deemed satisfactory when this ratio is less than or equal to 2
- repeatability is considered satisfactory when it does not exceed the value of 0.66 x the Horwitz reproducibility

COMPENDIUM OF INTERNATIONAL METHODS OF ANALYSIS - OIV
Assay of pesticide residues in wine following extraction using
the Quechers method

TABLE 2: Reliability values

		Red wine 1	Red wine 2	White wine 1	White wine 2	Port	Muscat
metalaxyl	n	12	13	13	11	8	
	Average	0.051	0.041	0.105	0.033	0.014	
	TR%	102	103	82	69		
	CV _r %	6	8	6	9	5	
	CV _R %	26	26	17	26	33	
	PRCV _R %	25	26	22	27	30	
	HoR	1.1	1	0.9	0.6	1.1	
chlorpyrifos	n	9	12	11	11		
	Average	0.073	0.031	0.166	0.018		
	TR%	73	78	83	90		
	CV _r %	11	16	11	15		
	CV _R %	30	27	18	18		
	PRCV _R %	24	27	21	29		
	HoR	1.3	1	0.9	0.6		
tebuconazole	n	12	14	15	14		
	Average	0.025	0.078	0.05	0.04		
	TR%	100	98	100	100		
	CV _r %	6	10	10	9		
	CV _R %	37	30	30	31		
	PRCV _R %	28	23	25	26		
	HoR	1.3	1.3	1.2	1.2		
cyprodinil	n	15	14	13	14		
	Average	0.045	0.036	0.098	0.023		
	TR%	90	90	94	96		
	CV _r %	19	6	3	3		
	CV _R %	36	34	13	31		
	PRCV _R %	26	26	23	28		
	HoR	1.4	1.3	0.6	1.1		
tebufenozide	n	10		11			
	Average	0.049		0.106			
	TR%	98		106			
	CV _r %	16		6			
	CV _R %	25		30			
	PRCV _R %	25		22			
	HoR	1		1.3			

COMPENDIUM OF INTERNATIONAL METHODS OF ANALYSIS - OIV
Assay of pesticide residues in wine following extraction using
the Quechers method

TABLE 2 (continued): Reliability values

		Red wine 1	Red wine 2	White wine 1	White wine 2	Port	Muscat
fludioxonil	n	10		11	10		
	Average	0.026		0.064	0.015		
	TR%	104		98	100		
	CV _f %	4		8	10		
	CV _R %	47		30	43		
	PRCV _R %	28		24	30		
	HoR	1.7		1.2	1.4		
benalxyl	n	12	12	12	12		
	Average	0.046	0.04	0.099	0.023		
	TR%	88	98	95	110		
	CV _f %	8	7	7	14		
	CV _R %	37	32	25	21		
	PRCV _R %	25	26	23	28		
	HoR	1.4	1.2	1.1	0.8		
cyproconazole	n	14	15	14	14		
	Average	0.049	0.08	0.095	0.042		
	TR%	91	93	95	98		
	CV _f %	23	7	7	7		
	CV _R %	36	32	25	33		
	PRCV _R %	25	23	23	26		
	HoR	1.4	1.4	1.1	1.3		
tebufenpyrad	n	15	14	14	12		
	Average	0.042	0.038	0.094	0.021		
	TR%	84	95	94	105		
	CV _f %	21	6	5	6		
	CV _R %	33	31	26	32		
	PRCV _R %	26	31	26	32		
	HoR	1.3	1.2	1.1	1.1		
Pyraclostrobin	n	8		9			
	Average	0.055		0.121			
	TR%	110		121			
	CV _f %	6		5			
	CV _R %	31		26			
	PRCV _R %	25		22			
	HoR	1.2		1.2			

COMPENDIUM OF INTERNATIONAL METHODS OF ANALYSIS - OIV
Assay of pesticide residues in wine following extraction using
the Quechers method

TABLE 2 (continued): Reliability values

		Red wine 1	Red wine 2	White wine 1	White wine 2	Port	Muscat
Vinclozolin	n		10		9	11	11
	Average		0.031		0.020	0.039	0.08
	TR%		78		100	78	80
	CV _r %		8		10	14	4
	CV _R %		35		26	27	22
	PRCV _R %		24		29	26	23
	HoR		1.4		0.9	1	0.9
Mepanipyridin	n		12		13	10	11
	Average		0.063		0.028	0.022	0.046
	TR%		79		70	88	92
	CV _r %		8		24	5	7
	CV _R %		35		36	20	28
	PRCV _R %		24		27	29	25
	HoR		1.4		1.3	0.7	1.1
Boscalid	n	11	12		11	12	11
	Average	0.022	0.097		0.034	0.083	0.174
	TR%	105	121		85	83	87
	CV _r %	12	7		6	6	4
	CV _R %	45	30		26	16	17
	PRCV _R %	28	23		27	23	21
	HoR	1.6	1.3		1	0.7	0.8
Iprovalicarb	n	11	12			13	13
	Average	0.016	0.016			0.052	0.021
	TR%	107	114			104	100
	CV _r %	9	8			5	6
	CV _R %	39	38			28	27
	PRCV _R %	30	30			25	23
	HoR	1.3	1.3			1.1	1.2
Iprodione	n		10		10	10	8
	Average		0.079		0.039	0.053	0.101
	TR%		104		103	113	107
	CV _r %		10		7	10	13
	CV _R %		35		24	25	17
	PRCV _R %		23		26	25	22
	HoR		1.5		0.9	1	0.8

COMPENDIUM OF INTERNATIONAL METHODS OF ANALYSIS - OIV
Assay of pesticide residues in wine following extraction using
the Quechers method

TABLE 2 (continued): Reliability values

		Red wine 1	Red wine 2	White wine 1	White wine 2	Port	Muscat
Procymidone	n		11		11		
	Average		0.018		0.011		
	TR%		90		110		
	CV _r %		12		10		
	CV _R %		34		34		
	PRCV _R %		29		31		
	HoR		1.2		1.1		
Pyrimethanil	n		15	10	14		
	Average		0.036	0.011	0.027		
	TR%		60	46	120		
	CV _r %		9	20	7		
	CV _R %		26	31	25		
	PRCV _R %		26	31	28		
	HoR		1	1	0.9		
Carbendazim	n				8		9
	Average				0.057		0.033
	TR%				106		120
	CV _r %				11		10
	CV _R %				36		45
	PRCV _R %				25		27
	HoR				1.5		1.7
Fenbuconazole	n		8		7		
	Average		0.067		0.042		
	TR%		84		105		
	CV _r %		6		5		
	CV _R %		45		50		
	PRCV _R %		24		26		
	HoR		1.9		2		
Fenitrothion	n		11		10		
	Average		0.034		0.019		
	TR%		85		95		
	CV _r %		16		10		
	CV _R %		31		40		
	PRCV _R %		27		29		
	HoR		1.2		1.4		

COMPENDIUM OF INTERNATIONAL METHODS OF ANALYSIS - OIV
Assay of pesticide residues in wine following extraction using
the Quechers method

TABLE 2 (continued): Reliability values

		Red wine 1	Red wine 2	White wine 1	White wine 2	Port	Muscat
Metrafenone	n		7		7		
	Average		0.038		0.018		
	TR%		95		90		
	CV _T %		8		7		
	CV _R %		18		19		
	PRCV _R %		26		29		
	HoR		0.7		0.6		
Penconazole	n		14		13		
	Average		0.017		0.009		
	TR%		106		113		
	CV _T %		8		8		
	CV _R %		31		38		
	PRCV _R %		30		33		
	HoR		1		1.2		
Flusilazole	n		13		13		
	Average		0.035		0.019		
	TR%		88		95		
	CV _T %		6		9		
	CV _R %		37		36		
	PRCV _R %		26		29		
	HoR		1.4		1.2		
Oxadixyl	N	7				10	
	Average	0.04				0.023	
	TR%	80				92	
	CV _T %	10				5	
	CV _R %	18				31	
	PRCV _R %	26				28	
	HoR	0.7				1.1	
Azoxystrobine	N	12				13	
	Average	0.078				0.045	
	TR%	78				90	
	CV _T %	10				6	
	CV _R %	29				31	
	PRCV _R %	23				26	
	HoR	1.2				1.2	

COMPENDIUM OF INTERNATIONAL METHODS OF ANALYSIS - OIV
Assay of pesticide residues in wine following extraction using
the Quechers method

TABLE 2 (continued): Reliability values

		Red wine 1	Red wine 2	White wine 1	White wine 2	Port	Muscat
Dimethomorph	N	12		9	9	13	
	Average	0.086		0.019	0.019	0.047	
	TR%	86				94	
	CV _r %	6		8	14	8	
	CV _R %	30		41	44	29	
	PRCV _R %			29	29	25	
	HoR			1.4	1.5	1.2	
Fenhexamid	N	11		11	10	11	
	Average	0.083		0.026	0.025	0.039	
	TR%	83		96	93	78	
	CV _r %	7		9	10	7	
	CV _R %	31		18	19	18	
	PRCV _R %	23		28	28	26	
	HoR	1.3		0.6	0.7	0.7	

Determination of natamycin in wines

Résolution OIV-SCMA 461-2012

1. INTRODUCTION

Different methods for the determination of natamycin are used based mainly on HPLC in combination with DAD or MS detection. Estimation of the performance limits - limit of detection and quantification - relies on the responsibility of the laboratories according to accreditation systems (e.g. ISO/EN 17025/2005) employing the recommendations of the OIV (OENO 7/2000, E-AS1-10-LIMDET) or other normative guidelines.

As there is lack of a reliable interlaboratory estimate of the critical level, a decision limit of 5 µg/l is temporarily adopted until a reliable interlaboratory estimate or other robust indicators of the critical level can be obtained.

2. METHODS

2.1 Determination of natamycin (pimaricin) in wine by liquid chromatography coupled to high resolution mass spectrometry

2.1.1 SCOPE

This method describes an analytical procedure for the determination of natamycin (pimaricin) in wine. The level of natamycin is expressed in micrograms per litre (µg/l) of wine. In-house validation has been carried out using solvent solutions, red wine and white wine over the concentration range 5 – 2600 µg/l.

2.1.2 PRINCIPLE

The level of natamycin in wine is determined by direct injection of the sample into a liquid chromatograph with a high-resolution mass-spectrometric detection system (LC-HR/MS). Quantification is achieved using the standard addition method. The sample is initially analysed to gain an estimated concentration of natamycin. The analysis is then repeated with standard addition calibration standards more suited to the concentration of natamycin in the sample.

2.1.3 REAGENTS

2.1.3.1 Analytes

2.1.3.1.1 Natamycin (Pimaricin) > 95%

2.1.3.2 Chemicals

2.1.3.2.1 *Methanol, HPLC Fluorescence grade (CAS no. 67-56-1).*

2.1.3.2.2 *Purified water for laboratory use, for example of EN ISO 3696 grade (water for analytical laboratory use - specification and test methods [ISO 3696:1987]).*

2.1.3.2.3 *Acetic acid, 100%, (CAS no. 64-19-7)*

2.1.3.3 Solutions

2.1.3.3.1 *Stock solution of natamycin (1000 µg/ml)*

Weigh to the nearest 0.1 mg approximately 10 mg of natamycin (2.1.3.1.1) in a 10 ml amber volumetric flask and make up to the mark with methanol:water:acetic acid (2.1.3.3.4). Cap and sonicate. Calculate the actual concentration in micrograms of natamycin per millilitre of solution.

2.1.3.3.2 *Working solution 1: natamycin (10 µg/ml)*

Pipette 100 µl of stock solution (2.1.3.3.1) into a amber 10 ml volumetric flask and make up to the mark with methanol:water:acetic acid (2.1.3.3.4)

2.1.3.3.3 *Working solution 2: natamycin (0.5 µg/ml)*

Pipette 500 µl of working solution one (2.1.3.3.2) into an amber 10 ml volumetric flask and make up to the mark with methanol:water:acetic acid (2.1.3.3.4)

2.1.3.3.4 Solution of methanol:water:acetic acid (50:47:3, v/v)

Using a measuring cylinder, measure 500 ml of methanol (3.2.1) into a 1 L volumetric flask. Add 470 ml water (2.1.3.2.2) and shake to mix. Add 30 ml acetic acid (2.1.3.2.3) and shake well.

2.1.3.3.5 Methanol, 3% acetic acid

Using a measuring cylinder add 30 ml of acetic acid (2.1.3.2.3) to a 1 L volumetric flask. Make up to the mark with methanol (2.1.3.2.1) and shake well.

2.1.3.3.6 Water, 3% acetic acid

Using a measuring cylinder add 30 ml of acetic acid (2.1.3.2.3) to a 1 L volumetric flask. Make up to the mark with water (2.1.3.2.2) and shake well.

2.1.4 APPARATUS

NOTE: An instrument or item of apparatus is listed only where it is specialised or made to a particular specification, the usual laboratory glassware and equipment being assumed to be available.

2.1.4.1 Liquid Chromatograph (LC)

Equipped with an automatic injector, a 100 µl injection loop and a high resolution mass spectrometer.

2.1.4.1.1 LC column

Capable of obtaining reproducible natamycin peaks and capable of separating the natamycin peaks from interfering peaks originating from the sample matrix and/or the solvents used.

NOTE: Depending on the type of equipment used for the analysis, the appropriate operating conditions should be optimised.

2.1.4.1.2 *HPLC analysis*

The following column and parameters have been found to be suitable:

Column: Waters Sunfire C18, 150 x 2.1 mm, 3.5 µm
Column temperature: 30 °C
Flow rate: 0.25 ml/min
Injection volume: 20 µl
Mobile phase A: Water:acetic acid, 97:3 (v/v) (2.1.3.3.6)
Mobile phase B: Methanol:acetic acid, 97:3 (v/v) (2.1.3.3.5)
Run time: 30 min
Autosampler tray: 8 °C

Gradient:

Time (min)	Mobile phase A (%)	Mobile phase B (%)
0	90	10
25	10	90
27	10	90
27.1	90	10
30	90	10

2.1.4.2 Mass spectrometric detection (LC-HR/MS)

Ionisation mode:	positive electrospray
Mass resolution:	m/z/□m/z
AGC target:	High dynamic range
Max Inj time:	50 ms
Scan range:	m/z 480-670
Sweep gas:	60 L/min
Aux gas:	5 L/min
Spray voltage:	3.75 V
Natamycin:	m/z 666.31069 [M+H] ⁺ .
confirmation ion m/z	503.22672
Retention time:	16.5 mins

2.1.5 EXPERIMENTAL PROCEDURE

Samples should be shaken to ensure homogeneity prior to sub-sampling.

2.1.5.1 Screening

For each wine pipette 2 ml of sample into two 2 ml Eppendorf centrifuge vials. Add 0 µl, 20 µl and of natamycin working solution 2 at 0.5 µg/ml (2.1.3.3.3) to the vials respectively. This is equivalent to 0 µg/l and 5 µg/l natamycin added. Shake the vials for one minute and then centrifuge for 10 min at 14000 rpm. Filter an aliquot through 0.2 µm PTFE into an amber 2 ml vial. Analyse by LC-HR/MS (section 6) and estimate the concentration of natamycin in the sample (section 7).

If the estimated concentration of natamycin is less than 5 µg/l report the data as < 5 µg/l. If the estimated concentration of natamycin is greater than 5 µg/l follow section 5.2.

2.1.5.2 Quantitation

Natamycin determination for samples with an estimated concentration of greater than 5 µg/l. Pipette 2 ml of wine into five 2 ml Eppendorf centrifuge vials and add 0 µl, 5 µl, 10 µl, 20 µl and 50 µl of natamycin working solution 1 (2.1.3.3.2) into the vials respectively. This is equivalent to 0 µg/l, 25 µg/l, 50 µg/l, 100 µg/l and 250 µg/l natamycin added. Shake the vials for one minute and then centrifuge for 10 min at 14000 rpm. Filter an aliquot through 0.2 µm PTFE into an amber 2 ml vial. Analyse by LC-HR/MS (section 6) and estimate the concentration of natamycin in the sample (section 7).

2.1.6 ANALYSIS

NOTE: When starting measurements baseline stability and response linearity of the detector should be examined, together with verification of the detection limit. Maintain the same operating conditions throughout the measurement of all samples and calibration standards. Identify the natamycin peaks on the basis of the retention time and their accurate mass channel, and measure the peak areas. Inject each of the solutions as prepared onto the LC column. Measure the peak area of the natamycin peak in each of the quantification and confirmation channels. An example of a typical chromatogram is given in Figure 1.

COMPENDIUM OF INTERNATIONAL METHODS OF ANALYSIS - OIV

Determination of natamycin in wines

Figure 1. Typical LC-HR/MS chromatogram and mass spectrum for natamycin spiked into white wine at the equivalent of 50 µg/l in the sample.

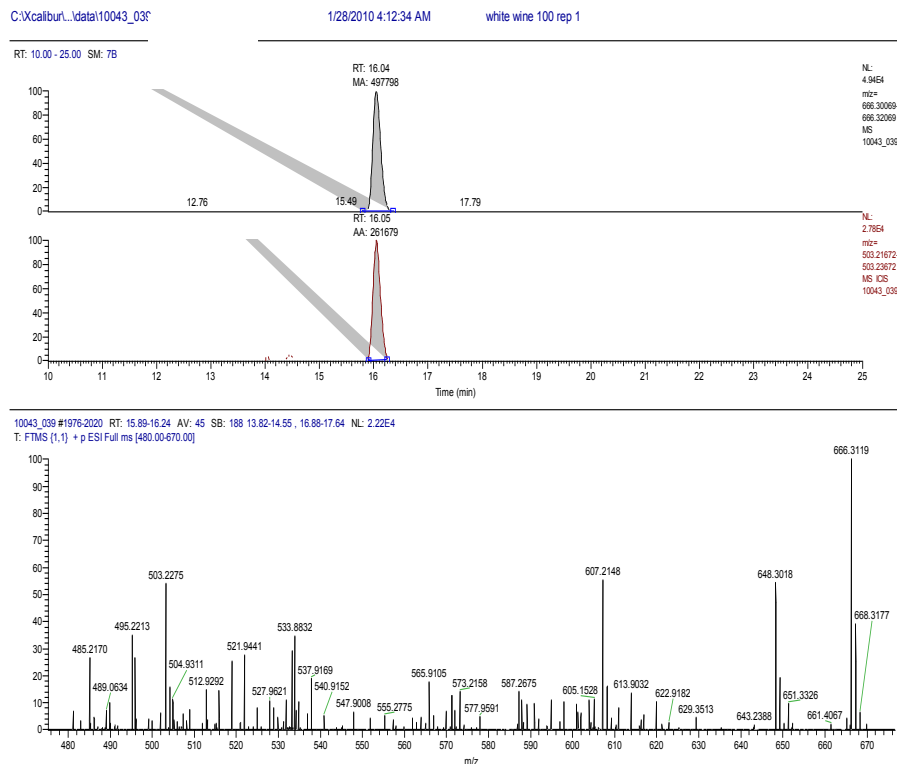

Plot the peak area for the main quantification channel against the concentration of natamycin added in micrograms per litre (µg/l). Determine the slope, intercept point and correlation coefficient of the regression line. The calibration curve shall be rectilinear and the correlation coefficient shall be 0.99 or better.

2.1.7 EXPRESSION OF RESULTS

2.1.7.1 Calculation of analyte level

The natamycin concentration in the sample in micrograms per litre ($\mu\text{g/l}$) is calculated using the following formula:

$$C = b/a$$

where C = concentration of natamycin in the wine ($\mu\text{g/l}$), a = slope of the regression line, b = y-intercept point of the regression line

2.1.8 CONFIRMATION

The presence of natamycin in the samples shall be confirmed by applying the following criteria:

The presence of a peak in both accurate mass channels m/z 666.31069 and m/z 503.22672 at the same retention time. Calculate the ratio of the peak area for the main quantification mass channel relative to the peak area of the confirmation channel. The criterion is that the ratios agree to $\pm 25\%$ of those obtained from the standard addition calibration standards.

2.1.9 METHOD PERFORMANCE DATA

2.1.9.1 Linearity

The method is linear over the calibration range of 1 to 2640 $\mu\text{g/l}$ in solvent, white wine and red wine matrices (figures 2, 3 and 4).

Figure 2. Ten point calibration graph of natamycin spiked into solvent in the range from 1 to 2600 µg/l.

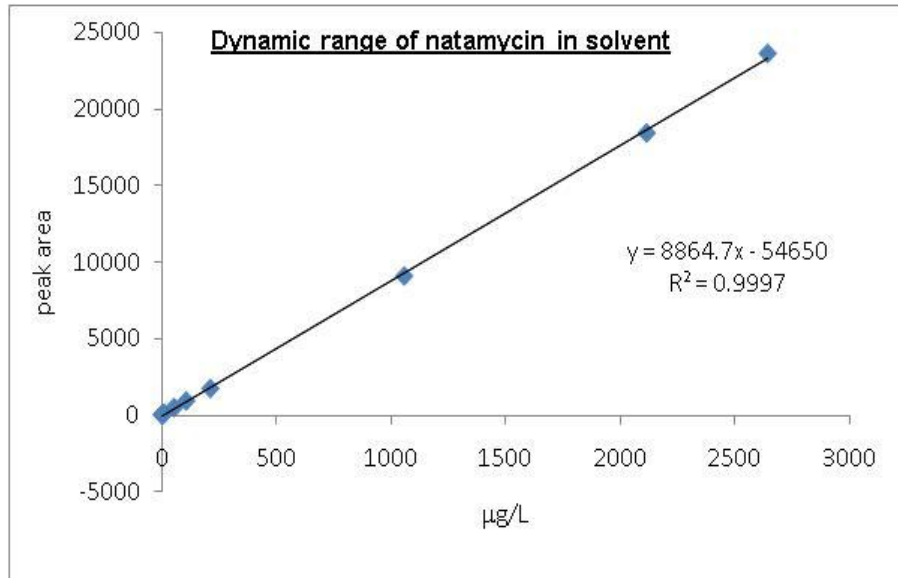

COMPENDIUM OF INTERNATIONAL METHODS OF ANALYSIS - OIV
Determination of natamycin in wines

Table 1. Solvent calibration residuals.

Natamycin (µg/l)	Predicted conc. (µg/l)	Residual s	Standard Residuals
0	6.4	-6.4	-0.4
1.056	6.8	-5.7	-0.3
5.28	10.9	-5.6	-0.3
10.56	16.8	-6.3	-0.4
52.8	58.9	-6.1	-0.3
105.6	108.3	-2.7	-0.2
211.2	200.1	11.1	0.6
1056	1029.8	26.2	1.5
2112	2084.8	27.2	1.6
2640	2671.8	-31.8	-1.8

Figure 3. Ten point calibration graph of natamycin spiked into white wine in the range from 1 to 2600 µg/l.

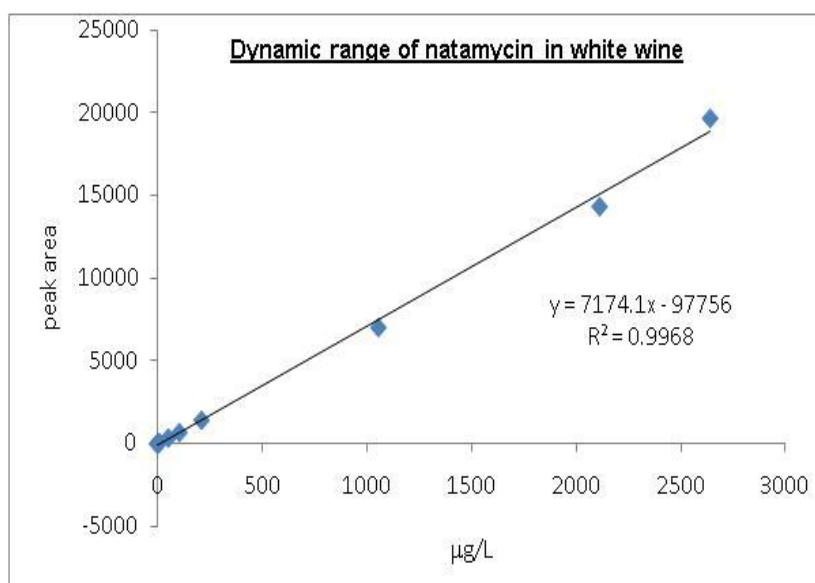

COMPENDIUM OF INTERNATIONAL METHODS OF ANALYSIS - OIV
Determination of natamycin in wines

Table 2 White wine matrix calibration residuals.

Natamycin ($\mu\text{g/l}$)	Predicted conc. ($\mu\text{g/l}$)	Residual s	Standard Residuals
0	15.5	-15.5	-0.3
1.056	15.6	-14.6	-0.3
5.28	18.8	-13.5	-0.2
10.56	23.9	-13.3	-0.2
52.8	63.6	-10.8	-0.2
105.6	109.3	-3.7	-0.1
211.2	212.8	-1.6	0.0
1056	989.0	67.0	1.2
2112	2003.2	108.8	2.0
2640	2742.7	-102.7	-1.8

Figure 4. Ten point Calibration graph of natamycin spiked into red wine in the range from 1 to 2600 $\mu\text{g/l}$.

COMPENDIUM OF INTERNATIONAL METHODS OF ANALYSIS - OIV
Determination of natamycin in wines

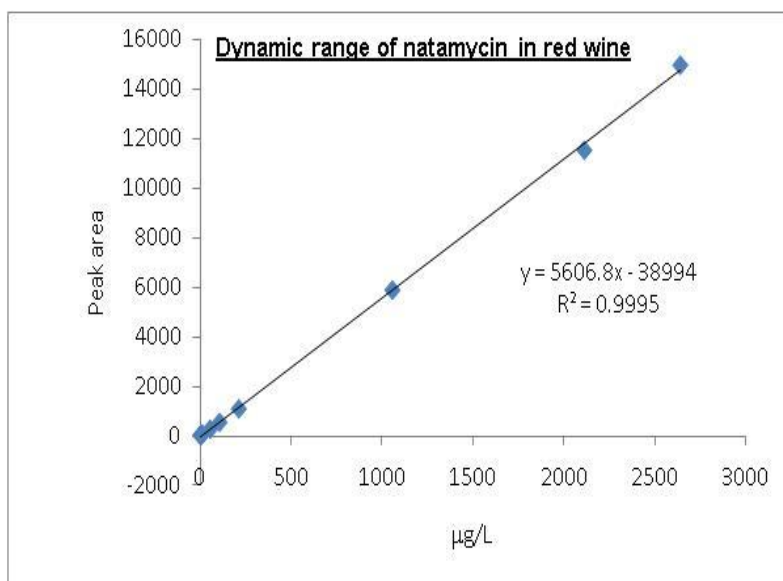

Table 3. Red wine matrix calibration residuals.

Natamycin (µg/l)	Predicted conc. (µg/l)	Residual s	Standard Residuals
0	7.2	-7.2	-0.3
1.056	8.2	-7.1	-0.3
5.28	10.9	-5.7	-0.3
10.56	16.8	-6.2	-0.3
52.8	52.1	0.7	0.0
105.6	102.1	3.5	0.2
211.2	199.8	11.4	0.5
1056	1055.2	0.8	0.0
2112	2063.7	48.3	2.3
2640	2678.4	-38.4	-1.8

2.1.9.2

Accuracy and Precision

The method was assessed for repeatability at the intervention limit of 5 µg/l and at 200 µg/l in solvent, white wine and red wine matrices (tables 4, 5 and 6). The accuracy was assessed by spiking a known amount at two different levels into white and red wine. The analysis was then performed by a second analyst without the knowledge of the spiked natamycin concentration. The results are shown in table 7.

COMPENDIUM OF INTERNATIONAL METHODS OF ANALYSIS - OIV
Determination of natamycin in wines

Table 4. Repeatability of natamycin spiked into solvent (methanol:water:acetic acid, 50:47:3 v/v) at two concentrations; 5 and 200 µg/l.

	Conc. Natamycin ug/l	Recovery (%)
Solvent std at 5 ng/ml rep 1	5.3	99.7
Solvent std at 5 ng/ml rep 2	5.4	101.8
Solvent std at 5 ng/ml rep 3	5.8	108.6
Solvent std at 5 ng/ml rep 4	5.7	108.2
Solvent std at 5 ng/ml rep 5	5.8	109.0
Solvent std at 5 ng/ml rep 6	5.9	112.2
Solvent std at 5 ng/ml rep 7	5.7	108.4
Solvent std at 5 ng/ml rep 8	6.4	120.2
Average	5.8	108.5
Std deviation	0.3	6.2
RSD (%)	5.7	5.7
Solvent std at 200 ng/ml rep 1	238.3	112.9
Solvent std at 200 ng/ml rep 2	237.1	112.4
Solvent std at 200 ng/ml rep 3	231.5	109.7
Solvent std at 200 ng/ml rep 4	228.0	108.1
Solvent std at 200 ng/ml rep 5	244.0	115.7
Solvent std at 200 ng/ml rep 6	220.7	104.6
Solvent std at 200 ng/ml rep 7	229.4	108.7
Solvent std at 200 ng/ml rep 8	251.7	119.3
Average	235.1	111.4
Std deviation	9.8	4.7
RSD (%)	4.2	4.2

COMPENDIUM OF INTERNATIONAL METHODS OF ANALYSIS - OIV
Determination of natamycin in wines

Table 5. Repeatability of natamycin spiked into white wine at two concentrations; 5 and 200 µg/l.

	Conc. Natamycin ug/l	Recovery (%)
White wine 5.3 ng/ml rep 1	5.3	99.1
White wine 5.3 ng/ml rep 2	4.4	82.8
White wine 5.3 ng/ml rep 3	5.1	96.0
White wine 5.3 ng/ml rep 4	4.9	92.5
White wine 5.3 ng/ml rep 5	4.6	86.4
White wine 5.3 ng/ml rep 6	5.1	96.4
White wine 5.3 ng/ml rep 7	4.8	90.9
White wine 5.3 ng/ml rep 8	4.9	92.2
Average	4.9	92.0
Std deviation	0.3	5.4
RSD (%)	5.9	5.9
White wine 211 ng/ml rep 1	217.6	103.1
White wine 211 ng/ml rep 2	223.3	105.8
White wine 211 ng/ml rep 3	213.0	101.0
White wine 211 ng/ml rep 4	216.8	102.7
White wine 211 ng/ml rep 5	211.4	100.2
White wine 211 ng/ml rep 6	208.6	98.9
White wine 211 ng/ml rep 7	204.2	96.8
White wine 211 ng/ml rep 8	214.4	101.6
Average	213.7	101.3
Std deviation	5.8	2.8
RSD (%)	2.7	2.7

COMPENDIUM OF INTERNATIONAL METHODS OF ANALYSIS - OIV
Determination of natamycin in wines

Table 6. Repeatability of natamycin spiked into red wine at two concentrations; 5 and 200 µg/l.

	Conc. Natamycin ug/l	Recovery (%)
Red wine 5.3 ng/ml rep 1	5.3	99.7
Red wine 5.3 ng/ml rep 2	5.0	93.8
Red wine 5.3 ng/ml rep 3	3.8	72.5
Red wine 5.3 ng/ml rep 4	5.1	96.5
Red wine 5.3 ng/ml rep 5	5.0	95.0
Red wine 5.3 ng/ml rep 6	5.5	103.5
Red wine 5.3 ng/ml rep 7	4.3	80.9
Red wine 5.3 ng/ml rep 8	4.8	90.7
Average	4.9	91.6
Std deviation	0.5	10.2
RSD (%)	11.1	11.1
Red wine 211 ng/ml rep 1	183.9	87.1
Red wine 211 ng/ml rep 2	178.4	84.5
Red wine 211 ng/ml rep 3	181.1	85.8
Red wine 211 ng/ml rep 4	197.5	93.6
Red wine 211 ng/ml rep 5	178.2	84.5
Red wine 211 ng/ml rep 6	184.2	87.3
Red wine 211 ng/ml rep 7	181.2	85.9
Red wine 211 ng/ml rep 8	171.3	81.2
Average	182.0	86.2
Std deviation	7.5	3.6
RSD (%)	4.1	4.1

COMPENDIUM OF INTERNATIONAL METHODS OF ANALYSIS - OIV
Determination of natamycin in wines

Table 7. Accuracy of natamycin spiked into white and red wine at two concentrations; 125 and 220 µg/l.

	Theoretical concentration (µg/l)	Obtained concentration (µg/l)	Accuracy (%)	Z Score
White wine A rep 1	125	135	108	0.50
White wine A rep 2	125	142	114	0.85
White wine A rep 3	125	138	110	0.65
White wine B rep 1	220	230	105	0.28
White wine B rep 2	220	230	105	0.28
White wine B rep 3	220	239	109	0.54
Red wine A rep 1	220	213	97	-0.20
Red wine A rep 2	220	234	106	0.40
Red wine A rep 3	220	223	101	0.09
Red wine B rep 1	125	129	103	0.20
Red wine B rep 2	125	129	103	0.20
Red wine B rep 3	125	120	96	-0.25

Calculations

Z scores calculated as:

$$= (\text{obtained concentration} - \text{theoretical concentration}) / \text{target standard deviation}$$

Where:

Target standard deviation = 0.16 x spiked concentration

i.e according to Horwitz

2.2 **Détermination of natamycin (pimaricin) in wine by HPLC/DAD**

2.2.1 **Scope**

This method describes an analytical procedure for the determination of natamycin (pimaricin) in wine by HPLC. The level of natamycin is expressed in micrograms per litre (µg/l) of wine.

The described method has been laboratory validated taking into account the influence of the matrix wine (e.g. white wine or red wine).

2.2.2 **Principle**

Non-sparkling wine samples are directly injected into the HPLC system. Sparkling wine samples are degased first by filtration or by using an ultrasonic bath. The analyte is separated from the matrix on a C8-column. The fraction window with the analyte is automatically transferred to a C18-column for further separation. Natamycin is detected at 304 nm and 319 nm. Additionally the DAD spectrum is used for identification. Quantification is done with reference to external standards.

2.2.3 **Reagents and Material**

2.2.3.1 Reagents

- 2.2.3.1.1 Water, deionised
- 2.2.3.1.2 Methanol, HPLC grade (*CAS no. 67-56-1*).
- 2.2.3.1.3 Formic acid, p. a. (*CAS no. 64-18-6*).
- 2.2.3.1.4 Acetic acid, p. a. (*CAS no. 64-19-7*).
- 2.2.3.1.5 Hydrochloric acid, p. a., 0,1 N (*CAS no. 7647-01-0*).
- 2.2.3.1.6 Matrix wine, natamycin not detectable
- 2.2.3.1.7 Natamycin, > 95 % (*CAS no. 7681-93-8*).

COMPENDIUM OF INTERNATIONAL METHODS OF ANALYSIS - OIV
Determination of natamycin in wines

The purity is verified by photometric measurement at 291 nm, 304 nm and 319 nm of a natamycin solution in hydrochloric acid, 0,1 N against a blank of hydrochloric acid, 0,1 N:

Reference data according to the literature	291 nm	304 nm	319 nm
Extinction (1 Gew.% Natamycin, 1 cm cell)	758	1173	1070

Alternative:

After dilution (e. g. dilution factor 20) the stock solution (2.1.3.3.1.) can also be used for the photometric measurement, e. g. pipette 1,0 ml stock solution into a 20 ml volumetric flask and fill up to the mark with hydrochloric acid, 0,1 N. Measure against a blank with the same composition of solvents as the diluted stock solution.

2.2.3.2 Preparation of the mobile phase

2.2.3.2.1 Solutions for the mobile phase:

2.2.3.2.1.1 5 ml acetic acid added to 2 l methanol

2.2.3.2.1.2 5 ml acetic acid added to 2 l deionised water

2.2.3.2.2 Eluent 1: methanol-acetic acid / deionised water-acetic acid (65 / 35)

2.2.3.2.3 Eluent 2: methanol-acetic acid / deionised water-acetic acid (80 / 20)

2.2.3.3 Preparation of the stock and standard solutions

All solutions have a limited stability and have to be stored dark and cold in a refrigerator. The stock solution (2.1.3.3.1.1) has a shelf life up to several weeks but the concentration has to be checked shortly before usage (e.g. see alternative method, 2.2.3.1.7.). Dilution I (2.2.3.3.1.2) and II (2.2.3.3.1.3) and the standard solutions (2.2.3.3.2) have to be prepared daily.

2.2.3.3.1 Preparation of the stock solution and dilutions

2.2.3.3.1.1 Stock solution (approximately 100 mg/l)

Weight in about 5 mg natamycin (3.1.7) and transfer with methanol into a 50 ml volumetric flask. Add 0,5 ml formic acid, make sure that all the natamycin is dissolved, temperate at 20 °C and make up to the mark with methanol.

2.2.3.3.1.2 Dilution I (approximately 5 mg/l)

Pipette 2,5 ml of the stock solution (2.1.3.3.1.1) into a 50 ml volumetric flask and make up to the mark with deionised water.

2.2.3.3.1.3 Dilution II (approximately 1 mg/l)

Pipette 4 ml of Dilution I (2.2.3.3.1.2) into a 20 ml volumetric flask and make up to the mark with the matrix wine (2.2.3.1.6).

2.2.3.3.2 Preparation of the standard solutions

For the standard solutions dilute Dilution II (2.2.3.3.1.3) to the desired concentrations with the matrix wine (2.2.3.1.6), e. g. 50 µl into a 10 ml volumetric flask equals 5 µg/l:

Volumetric flask	10 ml	10 ml	10 ml	10 ml	10 ml	10 ml	10 ml
Volume of Dilution II (µl)	50	100	200	400	500	1000	3700
Amount of natamycin (µg/l)	5	10	20	40	50	100	370

2.2.4 Apparatus

Usual laboratory equipment, in particular the following:

- 2.2.4.1 HPLC-DAD apparatus with a 6 port HPLC valve and two isocratic pumps or a gradient pump to enable fractionation
- 2.2.4.2 HPLC-column RP-8
- 2.2.4.3 HPLC-column RP-18
- 2.2.4.4 Photometer

2.2.5 Sampling

Non-sparkling wine samples are directly injected into the HPLC system. Sparkling wine samples are first degased by filtration or by using an ultrasonic bath. If samples need to be stored the storage conditions should be cold and dark.

2.2.6. Procedure

2.2.6.1. Operating conditions of HPLC

The following columns and parameters have been found to be suitable:

COMPENDIUM OF INTERNATIONAL METHODS OF ANALYSIS - OIV
Determination of natamycin in wines

Column 1: C 8-column (e.g. Select B 125*4mm/5µm endcapped, Merck)

Mobile phase: Eluent 1 (2.2.3.2.2) at room temperature

Flow rate: 1 ml/min

Column 2: C 18-column (e.g. Lichrospher 125*4mm/5µm, Merck)

Mobile phase: Eluent 2 (2.2.3.2.3) at 30°C

Flow rate: 1 ml/min

Injection volume: 500 µl

UV-detection: 304 nm and 319 nm

Fraction window: The position of the fraction window has to be checked prior to the following analysis (fig. 1). The range of the fraction window has to be set at 0,5 min. before and after the desired peak elutes from the C 8-column.

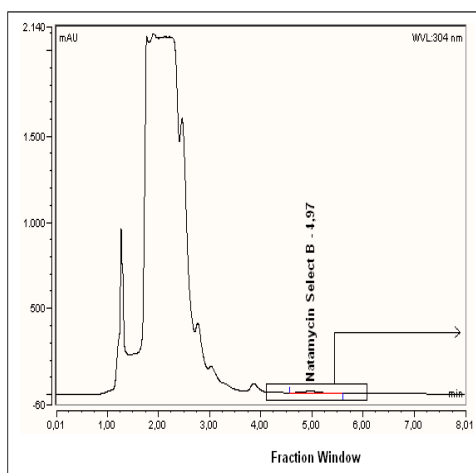

Fig. 1 Column 1
Fraction window

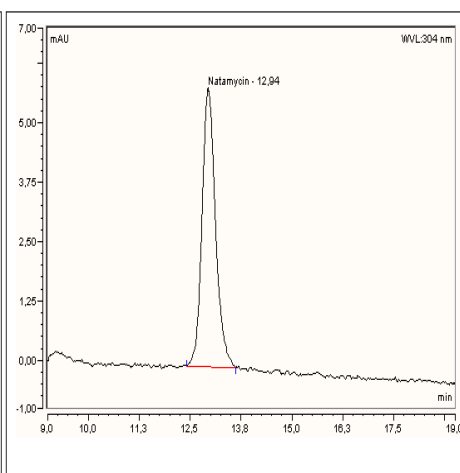

Fig. 2 Column 2
White wine spiked with natamycin (50 µg/l)

2.2.6.2 Identification/ Confirmation

Identification of peaks is done by the comparison of retention times between standards and samples for both measured wavelengths 304 nm and 319 nm. Using the chromatographic system and parameters of 2.2.6.1 the retention time for natamycin is approximately 12,9 min (fig. 2).

The DAD spectrum is used for further confirmation of positive findings (fig. 3 and fig. 4).

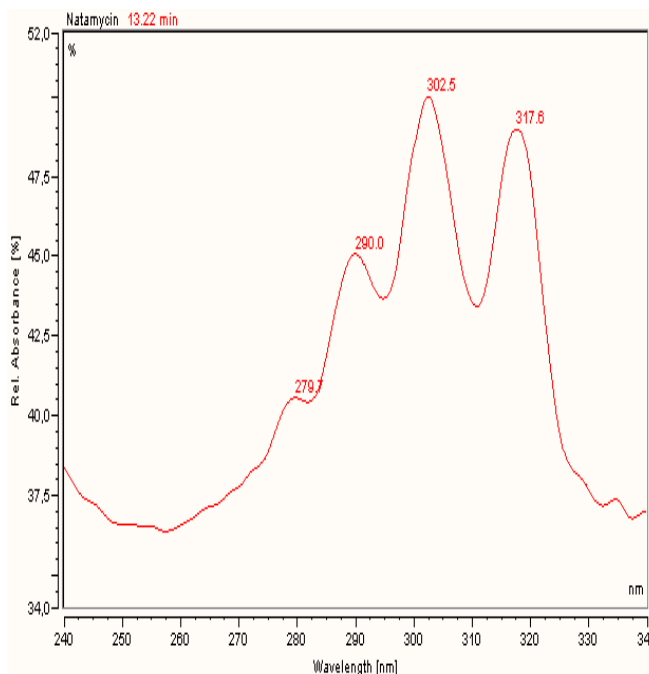

Fig. 4 DAD spectra of natamycin

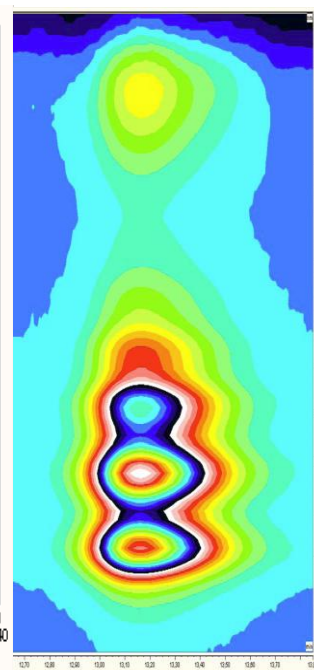

Fig. 3 3D-DAD spectra of natamycin

2.2.7. Calculation and expression of results

A calibration curve of the standard solutions (2.2.3.3.2) is prepared using the chromatograms measured at 304 nm. The quantification of natamycin is performed following the external calibration method. A linear calibration curve is generated by comparison of the peak areas and the relevant concentrations. The correlation coefficient should be at least 0,99.

The expression of the results is $\mu\text{g/l}$.

2.2.8. Method performance data

Detection limit, Quantification limit

The detection limit and quantification limit were determined according to DIN 32645 (direct determination: multiple measurement of a blank matrix sample, n=10, and a calibration curve that covers the total working range).

Detection limit: 2,5 µg/l

Quantification limit: 8,5 µg/l

Linearity

The linearity in a wine matrix is confirmed in the calibration range of 5 µg/l to 100 µg/l (fig. 5).

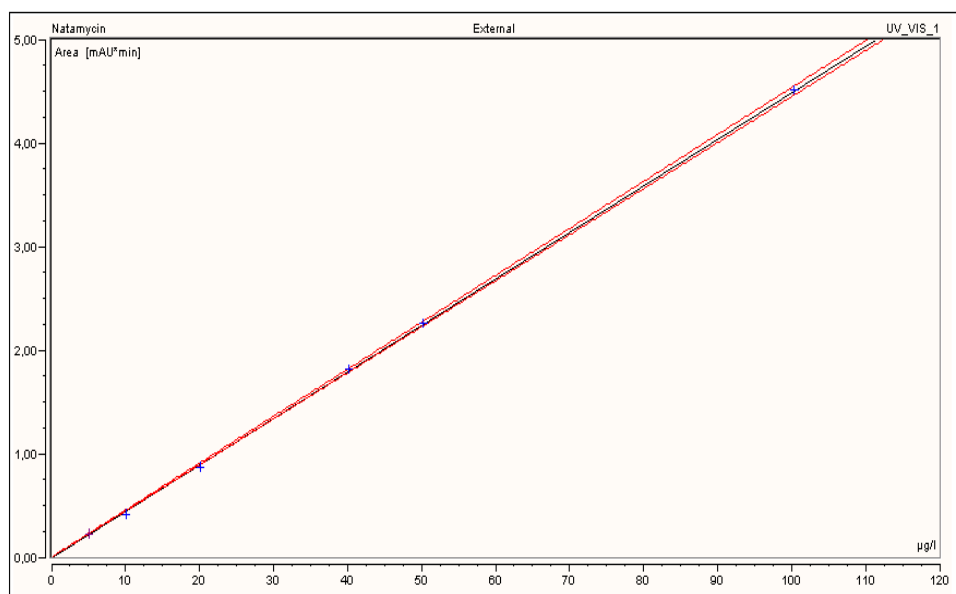

Fig. 5 Six point calibration graph of natamycin spiked into white wine matrix in the range from 5 to 100 µg/l, $R^2=0,9999$

COMPENDIUM OF INTERNATIONAL METHODS OF ANALYSIS - OIV
Determination of natamycin in wines

2.2.9 Trueness and Precision

Trueness and repeatability were assessed by spiking a known amount of natamycin into white, rosé and red wine and measuring each of these samples five times. The results are shown in table 1.

Matrix	Natamycin content in matrix (µg/l)	Spiked natamycin content (µg/l)	Measured natamycin content (µg/l)	Recovery rate (%)	Z-Score
White wine	n. d.	5.02	5.04	100.4	0.0
			4.70	93.6	-0.2
			5.12	102.0	0.1
			5.29	105.4	0.2
			4.97	99.0	0.0
		Average	5.02	100.1	
		Std dev.	0.22		
		RSD (%)	4.3		
		Repeatability r	0.85		
Rosé wine	n. d.	5.02	4.79	95.4	-0.1
			4.83	96.2	-0.1
			4.76	94.8	-0.1
			4.79	95.4	-0.1
			4.73	94.2	-0.2
		Average	4.78	95.2	
		Std dev.	0.04		
		RSD (%)	0.78		
		Repeatability r	0.15		
Red wine	n. d.	5.02	4.61	91.8	-0.2
			4.65	92.6	-0.2
			4.89	97.4	-0.1
			4.67	93.0	-0.2
			4.34	86.5	-0.4
		Average	4.63	92.3	
		Std dev.	0.20		
		RSD (%)	4.2		
		Repeatability r	0.77		
Red wine	n. d.	21.2	19.73	93.1	-0.2
			20.66	97.5	-0.1
			21.16	99.8	0.0
			19.73	93.1	-0.2

COMPENDIUM OF INTERNATIONAL METHODS OF ANALYSIS - OIV
Determination of natamycin in wines

			19.58	92.4	-0.3
		Average	20.17	95.2	
		Std dev.	0.70		
		RSD (%)	3.5		
		Repeatability r	2.7		
Red wine	n.d.	53.2	51.84	97.4	-0.1
			51.91	97.6	-0.1
			51.42	96.7	-0.1
			50.12	94.2	-0.2
			50.62	95.2	-0.2
		Average	51.18	96.2	
		Std dev.	0.78		
		RSD (%)	1.5		
		Repeatability r	3.1		

Table 1 Accuracy of natamycin spiked into white, rosé and red wine; n.d. “not detected”. detection limit 2.5 µg/l

Calculations (Table 1):

$$\text{Repeatability } r = \text{Std dev.} \cdot t_{4;0.95} \cdot 2^{1/2}$$

$$Z \text{ score} = (\text{measured amount} - \text{spiked amount}) / \text{target standard deviation} \cdot$$

* according to Horwitz

$$\text{target standard deviation} = 1/100 \cdot \text{spiked amount} \cdot 2^{(1 - 0.5 \log \text{spiked amount})}$$

References

DIN 32645:2008-11

UV- und IR-Spektren wichtiger pharmazeutischer Wirkstoffe. Editio Cantor Aulendorf. 1978. Herausgeber/ Editor Hans-Werner Dibbern in Zusammenarbeit mit E. Wirbitzki

Macarthur R. Feinberg M. Bertheau Y. 2010. Construction of measurement uncertainty profiles for quantitative analysis of genetically modified organisms based on interlaboratory validation data. Journal of the Association of Official Analytical Chemists. 93(3). 1046 – 1056.

FV 1351. Dominic Roberts and Adrian Charlton. Determination of natamycin in wine by liquid chromatography coupled to high resolution mass spectrometry: standard operating procedure and method performance data. OIV SCMA March 2010.

FV 1355. Tomasz Brzezina. Natamycin in Wein. OIV SCMA March 2010.

Method OIV-MA-AS323-10

Type II/IV methods

Method of determination of phthalates
by gas chromatography / mass spectrometry in wines
OIV-OENO 477-2013
revised by OIV-OENO 596-2019

1. SCOPE

This method applies to the detection and assay of phthalates in wines.

2. PRINCIPLE

The sample is extracted using isohexane. The extract is concentrated by evaporation. The concentrated extract is analysed by gas chromatography/mass spectrometry (GC/MS) with deuterated internal standards.

3. REAGENTS AND MATERIALS

Unless otherwise specified, all the reagents used are of recognised analytical quality.

- 3.1 DMP (dimethyl phthalate) [CAS N°: 131-11-3]
- 3.2 DnBP (dibutyl phthalate) [CAS N°: 84-74-2]
- 3.3 DEHP (bis (2-ethylhexyl) phthalate) [CAS N°: 117-81-7]
- 3.4 BBP (butyl benzyl phthalate) [CAS N°: 85-68-7]
- 3.5 DINP (di-isononyl phthalate) [CAS N°: 068515-48-0/028553-12-0]
- 3.6 DIDP (di-isodecyl phthalate) [CAS N°: 068515-49-1/026761-40-0]
- 3.7 DCHP (dicyclohexyl phthalate) [CAS N°: 84-61-7]
- 3.8 DEP (diethyl phthalate) [CAS N°: 84-66-2]
- 3.9 DiBP (di-isobutyl phthalate) [CAS N°: 84-74-2]
- 3.10 DnOP (di-n-octyl phthalate) [CAS N°: 117-84-0]
- 3.11 DMP-d4: internal standard [CAS N°: 93951-89-4]
- 3.12 DEP-d4: internal standard [CAS N°: 93952-12-6]
- 3.13 DiBP-d4: internal standard [CAS N°: 358730-88-8]
- 3.14 DnBP-d4: internal standard [CAS N°: 93952-11-5]

COMPENDIUM OF INTERNATIONAL METHODS OF ANALYSIS - OIV
Method of determination of phthalates
by gas chromatography / mass spectrometry in wines

- 3.15 BBP-d4: internal standard [CAS N°: 93951-88-3]
- 3.16 DCHP-d4: internal standard [CAS N°: 358731-25-6]
- 3.17 DEHP-d4: internal standard [CAS N°: 93951-87-2]
- 3.18 DnOP-d4: internal standard [CAS N°: 93952-13-7]
- 3.19 Isohexane [CAS N°: 107-83-5] and Acetone [CAS N°: 67-64-1]

3.20 Standard solutions

All the volumetric flasks used to prepare the calibration solutions are to be rinsed with acetone then isohexane to avoid any contamination.

3.20.1. Stock solutions

- Phthalate - 1 g/L individual solution: for each phthalate weigh 100 mg into a 100 mL flask, dissolve in the isohexane and make up to 100 mL.
- DINP-DIDP - 5 g/L individual solution: for each phthalate weigh 500 mg into a 100 mL flask, dissolve in the isohexane and make up to 100 mL.
- Internal standard - 0.5 g/L individual solution: deuterated standards are packaged in sealed 25 mg ampoules; for each internal standard, all the contents of the bulb are transferred into a 50 mL volumetric flask; make up to 50 mL with isohexane.

3.20.2. Working solutions

- Phthalate 1 mg/L working solution (S1)
Take 100 µL of each 1 g/L and 5g/L stock solution (3.20.1), add the samples to a 100 mL flask, and make up to 100 mL with isohexane.
- Phthalate 10 mg/L working solution (S2)
Take 1 mL of each 1 g/L and 5g/L stock solution (3.20.1), add the samples to a 100 mL flask, and make up to 100 mL with isohexane.
- Internal standard 10 mg/L working solution (IS)

COMPENDIUM OF INTERNATIONAL METHODS OF ANALYSIS - OIV
Method of determination of phthalates
by gas chromatography / mass spectrometry in wines

Take 1 mL of each deuterated standard 0.5 g/L stock solution (3.20.1), add the samples to a 50 mL flask, and make up to 50 mL with isohexane.

3.20.3. Calibration range

The calibration range in isohexane is prepared from the various working solutions (3.20.2), directly into the injection vials that have been heat-treated, rinsed (see § 5.1) and dried under a hood beforehand, according to the following table:

Calibration points	Phthalate concn. (mg/L)*	Vol. of S1 surrogate soln. (µL)	Vol. of S2 surrogate soln. (µL)	Vol. of IS surrogate soln. (µL)	Vol. of isohexane (µL)
C1	0	0	0	50	1000
C2	0,05	50	0	50	950
C3	0,10	100	0	50	900
C4	0,20	200	0	50	800
C5	0,50	0	50	50	950
C6	0,80	0	80	50	920
C7	1,00	0	100	50	900

* to be multiplied by 5 for DINP and DIDP concentrations

4. EQUIPMENT

4.1 Glassware and volumetric laboratory equipment:

- 4.1.1 50 mL and 100 mL class A volumetric flasks
- 4.1.2 50 mL glass centrifuge tubes with stopper
- 4.1.3 10 mL glass test tubes with stopper
- 4.1.4 Micropipettes with variable volumes ranging from 25 µl to 1,000 µl, checked in accordance with ISO 8655-6
- 4.1.5 Nitrogen flow evaporator

4.2 Analytical balance

4.3 GC-MS System (e.g. Varian 450GC-300MS)

5. PROCEDURE

5.1 Precautions

Due to the presence of phthalates in the laboratory environment, precautions must be taken throughout the analysis of these compounds:

- Avoid any contact with plastic equipment (especially flexible PVC) as much as possible. If this is not possible, make sure there is no contamination.
- Test the solvents used and dedicate bottles of solvent to these analyses.
- Heat-treat all non-volumetric glassware (400°C for at least 2 hours). Rinse all the equipment carefully (with acetone then isohexane).
- Make sure the septums of the injection vials are phthalate-free.
- Before and after each injection, rinse the injection syringe several times.
- If possible, work in a clean room or in a room reserved for these analyses.

5.2 Preparing the samples

Place 12.5 mL of the sample in a 50 mL centrifuge tube. Add 10 mL of isohexane.

Shake vigorously (Vortex mixer) for at least one minute.

Let the mixture decant until the 2 phases have separated (30 minutes in a 50°C ultrasound bath will accelerate the separation). Recover 8 mL of the organic phase and transfer it into a 10 mL test tube. Evaporate under a flow of nitrogen (0.3 bar) at 35°C and avoid continuing to dryness (warning: the temperature must not exceed 40°C)

Resume with 1 mL of isohexane.

Add 50 µl of the 0.01 g/L internal standard solution to each extract.

Transfer into an injection vial.

NOTE: to minimise matrix effects during analysis by GC-MS, a “protective” agent can be added, such as methyl undecanoate [CAS N°: 1731-86-8].

Add 20µL of this compound is added to each calibration solution and to the extracts from the samples prior to evaporation under a flow of nitrogen.

5.3 Blank test

COMPENDIUM OF INTERNATIONAL METHODS OF ANALYSIS - OIV
Method of determination of phthalates
by gas chromatography / mass spectrometry in wines

Prepare a “blank” test by following the procedure described in 5.2 without adding the sample.

5.4 GC/MS analysis

Depending on the apparatus available and its performance, choose between SIM and MRM modes for the mass spectrometry.

For information purposes, analysis conditions are provided in Appendix I and a typical chromatogram is provided in Appendix II.

5.4.1 Calibration

First, carry out several solvent injections (at least 2). Next, inject the standard solutions (3.20.3) in duplicate in increasing order of concentration and end with at least two solvent injections.

Establish a calibration curve for each phthalate:

$$(A_{\text{analyte}}/A_{\text{IS}}) = f(C_{\text{analyte}}/C_{\text{IS}}).$$

A: peak area

C: concentration

IS: internal standard

Each phthalate is quantified using to the corresponding deuterated standard, with the exception of DINP and DIDP which are quantified using to DnOP-d4.

5.4.2 Analysing the samples

Start the analysis sequence by analysing the "blank" test (5.3).

Then inject the samples prepared (5.2) in duplicate.

Plan solvent injections after potentially highly contaminated samples.

COMPENDIUM OF INTERNATIONAL METHODS OF ANALYSIS - OIV
Method of determination of phthalates
by gas chromatography / mass spectrometry in wines

End the series by injecting one or more calibration standards to check any signal drift during the analysis series and to check several solvent injections..

For each injection, measure the area of the identified peaks and internal standards, and use the calibration curve equation (5.4.1) to determine the concentration in the extract analysed.

5.4.3 Expressing the results

For each sample, calculate the average of the results obtained (5.4.2) for both injections.

The results are expressed in mg/L.

6. QUALITY CONTROL

During each analysis series, quality control is provided by the analysis of a wine sample supplemented with phthalates at a concentration level of 0.020 mg/L.

The extract of the sample prepared as per 5.2 is analysed at the beginning of the series, and the results obtained, given in terms of recovery rate, are reflected on a control chart.

7. METHOD CHARACTERISTICS

The analyses performed in the laboratory, under repeatability and intermediate precision conditions, on a red wine and a white wine supplemented with phthalates at two concentration levels (0.040 mg/L and 0.080 mg/L), gave the following repeatability ($CV_r\%$), intermediate reproducibility ($CV_{IP}\%$), and recovery values:

Phthalates	Recovery %	$CV_r\%$	$CV_{IP}\%$
DMP (dimethyl phthalate)	67	5	8
DEP (diethyl phthalate)	84	8	11

COMPENDIUM OF INTERNATIONAL METHODS OF ANALYSIS - OIV
Method of determination of phthalates
by gas chromatography / mass spectrometry in wines

DiBP (di-isobutyl phthalate)	93	7	10
DnBP (dibutyl phthalate)	95	5	7
BBP (butyl benzyl phthalate)	98	5	6
DCHP (dicyclohexyl phthalate)	97	5	7
DEHP (bis(2-ethylhexyl) phthalate)	98	6	7
DnOP (dioctyl phthalate)	98	6	7
DINP (di-isononyl phthalate)	104	7	8
DIDP (di-isodecyl phthalate)	96	8	11

i.e. the following average values for all the phthalates:

Repeatability (given in $CV_r\%$): **6%**

Intermediate precision (given in $CV_{IP}\%$): **8%**

8. DETECTION AND QUANTIFICATION LIMITS

For each phthalate being analysed for, the detection and quantification limits are provided in the following table:

Phthalates	Quantification limit (mg/L)	Detection limit (mg/L)
DMP (dimethyl phthalate)	0.010	0.004
DEP (diethyl phthalate)	0.010	0.004

COMPENDIUM OF INTERNATIONAL METHODS OF ANALYSIS - OIV
Method of determination of phthalates
by gas chromatography / mass spectrometry in wines

DiBP (di-isobutyl phthalate)	0.010	0.004
DnBP (dibutyl phthalate)	0.010	0.004
BBP (butyl benzyl phthalate)	0.010	0.004
DCHP (dicyclohexyl phthalate)	0.010	0.004
DEHP (bis(2-ethylhexyl) phthalate)	0.010	0.004
DnOP (dioctyl phthalate)	0.010	0.004
DINP (di-isononyl phthalate)	0.050	0.020
DIDP (di-isodecyl phthalate)	0.050	0.020

9. REFERENCES

- FV 1371. Detection and assay of phthalates in alcoholic beverages. 2011
FV 1234. Questions about phthalates. 2006

APPENDIX I (for information)

Gas chromatography conditions

VF-5ms type capillary column: 30 m x 0.25 mm internal diameter, film thickness 0.25 µm

COMPENDIUM OF INTERNATIONAL METHODS OF ANALYSIS - OIV
Method of determination of phthalates
by gas chromatography / mass spectrometry in wines

Temperature programming:

For detection in SIM mode:

Oven maintained at 100°C for 1 min; increase to 230°C at a rate of 10°C/min; increase to 270°C at a rate of 10°C/min; maintain for 2 min, increase to 300°C at a rate of 25°C/min; maintain for 8 min.

Note: this programming separates the DEHP and DCHP peaks (which cannot be done with the MRM mode programming)

For detection in MRM mode:

Oven maintained at 80°C for 1 min; increase to 200°C at a rate of 20°C/min; increase to 300°C at a rate of 10°C/min; maintain for 8 min.

Injector: maintained at 150°C for 0.5 min; increase to 280°C at a rate of 200°C/min, in splitless mode at injection

Helium: 1 mL/min at a constant flow rate

Volume injected: 1 µL

Mass spectrometry (MS) conditions

Ionisation in EI mode at 70 eV
Source temperature: 250°C
Transfer line temperature: 300°C
Manifold: 40°C

Phthalate quantification and identification parameters

For an analysis in SIM mode, table 1 provides the quantification ion and the two qualifier ions for each phthalate and its deuterated homologue.

For an analysis in MRM mode, table 2 reflects the quantifying and qualifying transitions for each phthalate and its deuterated homologue.

COMPENDIUM OF INTERNATIONAL METHODS OF ANALYSIS - OIV
Method of determination of phthalates
by gas chromatography / mass spectrometry in wines

Note: DIDP and DINP are each a mixture of compounds. Chromatography cannot separate them completely. They are therefore assayed as a "group".

APPENDIX I
(for information)

Table 1

		Quantification ion m/z	Qualifier ions m/z	
			1	2
DMP	(dimethyl phthalate)	163	77	194
DMP-d4		167	81	198
DEP	(diethyl phthalate)	149	177	222
DEP-d4		153	181	226
DiBP	(di-isobutyl phthalate)	149	167	223
DiBP-d4		153	171	227
DnBP	(dibutyl phthalate)	149	205	223
DnBP-d4		153	209	227
BBP	(butyl benzyl phthalate)	149	91	206
BBP-d4		153	95	210
DCHP	(dicyclohexyl phthalate)	149	167	249
DCHP-d4		153	171	253
DEHP	(bis(2-ethylhexyl) phthalate)	149	167	279
DEHP-d4		153	171	283
DnOP	(dioctyl phthalate)	149	167	279
DnOP-d4		153	171	283
DINP	(di-isononyl phthalate)	149	293	
DIDP	(di-isodecyl phthalate)	149	307	

COMPENDIUM OF INTERNATIONAL METHODS OF ANALYSIS - OIV
Method of determination of phthalates
by gas chromatography / mass spectrometry in wines

Table 2

		Quantifying transition	Qualifying transition
DMP	(dimethyl phthalate)	194>163	194>77
DMP-d4		198>167	198>81
DEP	(diethyl phthalate)	177>149	177>93
DEP-d4		181>153	181>97
DiBP	(di-isobutyl phthalate)	223>149	205>149
DiBP-d4		227>153	209>153
DnBP	(dibutyl phthalate)	223>149	205>149
DnBP-d4		227>153	209>153
BBP	(butyl benzyl phthalate)	206>149	149>121
BBP-d4		210>153	153>125
DCHP	(dicyclohexyl phthalate)	249>149	249>93
DCHP-d4		253>153	253>97
DEHP	(bis(2-ethylhexyl) phthalate)	279>149	279>93
DEHP-d4		283>153	283>97
DnOP	(dioctyl phthalate)	279>149	279>93
DnOP-d4		283>153	283>93
DINP	(di-isononyl phthalate)	293>149	
DIDP	(di-isodecyl phthalate)	307>149	

COMPENDIUM OF INTERNATIONAL METHODS OF ANALYSIS - OIV
Method of determination of phthalates
by gas chromatography / mass spectrometry in wines

APPENDIX II
(for information)

GC/MS chromatograms of a phthalate standard solution and deuterated internal standards.

COMPENDIUM OF INTERNATIONAL METHODS OF ANALYSIS - OIV
Method of determination of phthalates
by gas chromatography / mass spectrometry in wines

APPENDIX III
(for information)

VALIDATION OF ANALYSIS OF PHTHALATES IN WINES

1. Executive Summary

The Institute for Reference Materials and Measurements (IRMM) organised in close collaboration with the International Organisation of Vine and Wine (OIV) this collaborative study to validate *Compendium* method OIV-MA-AS323-10:2013 for the determination of ten phthalates in wine by gas chromatography - mass spectrometry (GC-MS).

The design of the method performance study complied with provisions given in ISO 5725-2 and those established by the OIV. The test samples consisted of red wine, white wine, and sweet wine presented as blind duplicates (see Table 1).

The wines were spiked at IRMM, bottled into ampoules, and dispatched to the participants of the validation study.

In addition to the test samples, participants received a deuterated phthalate solution, in order to be able to prepare the internal standard solutions.

The participants of the study were identified by the OIV following a pre-validation study for the method. They comprised laboratories from Europe, Asia, South America and Australia (see Table 2).

The evaluation of the reported results was performed according to ISO 5725-2 and ISO 5725-4, as well as the provisions established by the OIV. Relative standard deviations for reproducibility were mostly within the range of 9% to 71%.

Table 1

Sample	S001	S002	S003	S004	S005	S006
Nature	White wine		Red wine		Sweet wine	

2. Participants in the study

Table 2: Participants in the study

COMPENDIUM OF INTERNATIONAL METHODS OF ANALYSIS - OIV
Method of determination of phthalates
by gas chromatography / mass spectrometry in wines

Analab Chile S.A.	Chile
Animal & Plant & Food Inspection Centre, Tianjin Exit- Entry Inspection and Quarantine Bureau	People's Republic of China
Bureau Interprofessionnel du Cognac	France
Central National de Verificare a Calitatii Productiei Alcoolice	Republic of Moldova
Chemisches und Veterinaeruntersuchungsamt Stuttgart	Germany
Escola Superior de Biotecnologia Universidade Católica Portuguesa	Portugal
Instituto Nacional de Vitivinicultura Departamento de Normas Analíticas Especiales	Argentina
Laboratorio Arbitral Agroalimentario	Spain
Laboratoire DUBERNET	France
Miguel Torres S.A.	Spain
SAILab	Spain
SCL Laboratoire de Bordeaux	France
SCL Laboratoire de Montpellier	France
The Australian Wine Research Institute	Australia

3. Evaluation of submitted results

The fitness-for-purpose of the calculated reproducibility standard deviation was evaluated. For this purpose, the calculated reproducibility relative standard deviation (RSD_R) was compared to the relative standard deviation derived from the

COMPENDIUM OF INTERNATIONAL METHODS OF ANALYSIS - OIV
Method of determination of phthalates
by gas chromatography / mass spectrometry in wines

modified Horwitz equation (RSD_{mH}), as proposed by Thompson (Thompson 2000). The latter provides a concentration dependant guidance level for reproducibility. The agreement with the guidance level of precision was expressed as HORRAT values for reproducibility ($HORRAT_R$).

4. Evaluation of systematic effects

Laboratories reporting results that, for one or more analytes, exceeded the 1% threshold level of either the Mandel's h or Mandel's k tests were contacted by the organisers and requested to check their reported data and to confirm them if appropriate. Results were excluded from data evaluations if the laboratory did not confirm the correctness of the reported analytical results.

5. Evaluation of reported results by analyte

Based on the results of the separate analysis of each analyte and according to the reproducibility results, the method should be considered as either type II (DCHP BBP DBP DIBP DEP) or type IV (DIDP DINP DNOP DEHP DMP).

COMPENDIUM OF INTERNATIONAL METHODS OF ANALYSIS - OIV
Method of determination of phthalates
by gas chromatography / mass spectrometry in wines

Table 3: Dimethyl phthalate (DMP)¹ – Results of data evaluation

		S001	S002	S003	S004	S005	S006
No. of laboratories that submitted compliant results		11	10	11	10	10	11
Mean	mg/l	0.020	0.073	0.018	0.031	0.053	0.027
Median	mg/l	0.020	0.060	0.018	0.030	0.056	0.028
Assigned value	mg/l	0.030	0.097	0.030	0.049	0.104	0.046
Rel. dev. assign. value		-33.3%	-38.1%	-40.0%	-38.8%	-46.2%	-39.1%
Repeatability s.d.	mg/l	0.003	0.007	0.002	0.006	0.011	0.003
Reproducibility s.d.	mg/l	0.006	0.041	0.007	0.011	0.022	0.009
Rel. repeatability s.d.		9.42%	7.33%	8.04%	13.00%	10.25%	7.09%
Rel. reproducibility s.d.		20.10%	42.40%	23.12%	22.54%	21.10%	19.07%
Modified Horwitz s.d. **		22.00%	22.00%	22.00%	22.00%	22.00%	22.00%
HORRATR		0.91	1.93	1.05	1.02	0.96	0.87
Limit of repeatability, r (2.77 X sr)	mg/l	0.008	0.020	0.007	0.018	0.030	0.009
Limit of reproducibility, R (2.77 X sR)	mg/l	0.017	0.114	0.019	0.031	0.061	0.024
Rel. limit of repeatability		26.09%	20.32%	22.28%	36.00%	28.38%	19.64%
Rel. limit of reproducibility		55.67%	117.45%	64.05%	62.44%	58.45%	52.84%
No. of laboratories after elimination of outliers		9	9	8	8	9	10
No. of measurement values without outliers		18	18	15	16	18	20

¹ Type IV method

COMPENDIUM OF INTERNATIONAL METHODS OF ANALYSIS - OIV
Method of determination of phthalates
by gas chromatography / mass spectrometry in wines

Table 4: Diethyl phthalate (DEP)² – Results of data evaluation

		S001	S002	S003	S004	S005	S006
No. of laboratories that submitted compliant results		12	11	11	11	10	12
Mean	mg/l	0.048	0.065	0.030	0.039	0.021	0.059
Median	mg/l	0.044	0.076	0.029	0.041	0.023	0.061
Assigned value	mg/l	0.057	0.092	0.031	0.056	0.030	0.089
Rel. dev. assign. value		-22.8%	-17.4%	-6.5%	-26.8%	-23.3%	-31.5%
Repeatability s.d.	mg/l	0.006	0.010	0.005	0.004	0.003	0.002
Reproducibility s.d.	mg/l	0.026	0.026	0.015	0.017	0.008	0.019
Rel. repeatability s.d.		10.49%	11.32%	15.28%	7.00%	11.41%	2.53%
Rel. reproducibility s.d.		45.36%	28.49%	47.95%	29.71%	25.74%	20.98%
Modified Horwitz s.d. **		22.00%	22.00%	22.00%	22.00%	22.00%	22.00%
HORRATR		2.06	1.30	2.18	1.35	1.17	0.95
Limit of repeatability, r (2.77 X sr)	mg/l	0.017	0.029	0.013	0.011	0.009	0.006
Limit of reproducibility, R (2.77 X sR)	mg/l	0.072	0.073	0.041	0.046	0.021	0.052
Rel. limit of repeatability		29.05%	31.35%	42.32%	19.40%	31.60%	7.01%
Rel. limit of reproducibility		125.66%	78.91%	132.81%	82.29%	71.30%	58.12%
No. of laboratories after elimination of outliers		11	10	11	9	10	11
No. of measurement values without outliers		21	20	21	17	20	22

² Type II method

COMPENDIUM OF INTERNATIONAL METHODS OF ANALYSIS - OIV
Method of determination of phthalates
by gas chromatography / mass spectrometry in wines

Table 5: Diisobutyl phthalate (DIBP)³ – Results of data evaluation

		S001	S002	S003	S004	S005	S006
No. of laboratories that submitted compliant results		11	10	11	10	10	11
Mean	mg/l	0.049	0.087	0.076	0.119	0.054	0.046
Median	mg/l	0.049	0.085	0.076	0.123	0.055	0.045
Assigned value	mg/l	0.035	0.076	0.058	0.107	0.061	0.045
Rel. dev. assign. value		40.0%	11.8%	31.0%	15.0%	-9.8%	0.0%
Repeatability s.d.	mg/l	0.003	0.006	0.007	0.009	0.002	0.004
Reproducibility s.d.	mg/l	0.011	0.019	0.014	0.023	0.012	0.013
Rel. repeatability s.d.		7.43%	7.71%	11.55%	8.81%	4.04%	9.54%
Rel. reproducibility s.d.		32.18%	25.23%	24.48%	21.95%	19.98%	28.37%
Modified Horwitz s.d. **		22.00%	22.00%	22.00%	22.00%	22.00%	22.00%
HORRATR		1.46	1.15	1.11	1.00	0.91	1.29
Limit of repeatability, r (2.77 X sr)	mg/l	0.007	0.016	0.019	0.026	0.007	0.012
Limit of reproducibility, R (2.77 X sR)	mg/l	0.031	0.053	0.039	0.065	0.034	0.035
Rel. limit of repeatability		20.58%	21.35%	31.98%	24.42%	11.19%	26.44%
Rel. limit of reproducibility		89.15%	69.88%	67.80%	60.81%	55.35%	78.58%
No. of laboratories after elimination of outliers		11	10	11	10	10	11
No. of measurement values without outliers		21	20	21	20	20	22

³ Type II method

COMPENDIUM OF INTERNATIONAL METHODS OF ANALYSIS - OIV
Method of determination of phthalates
by gas chromatography / mass spectrometry in wines

Table 6: Dibutyl phthalate (DBP)⁴ – Results of data evaluation

		S001	S002	S003	S004	S005	S006
No. of laboratories that submitted compliant results		12	11	12	11	11	12
Mean	mg/l	0.103	0.264	0.078	0.728	0.090	0.178
Median	mg/l	0.103	0.266	0.074	0.666	0.089	0.174
Assigned value	mg/l	0.107	0.281	0.057	1.039	0.032	0.153
Rel. dev. assign. value		-3.7%	-5.3%	29.8%	-35.9%		
Repeatability s.d.	mg/l	0.009	0.014	0.011	0.033	0.004	0.012
Reproducibility s.d.	mg/l	0.022	0.048	0.021	0.314	0.018	0.022
Rel. repeatability s.d.		8.24%	5.03%	19.11%	3.21%	13.79%	7.87%
Rel. reproducibility s.d.		20.73%	17.01%	36.78%	30.25%	57.05%	14.66%
Modified Horwitz s.d. **		22.00%	19.36%	22.00%	15.91%	22.00%	21.22%
HORRATR		0.94	0.88	1.67	1.90	2.59	0.69
Limit of repeatability, r (2.77 X sr)	mg/l	0.024	0.039	0.030	0.092	0.012	0.033
Limit of reproducibility, R (2.77 X sR)	mg/l	0.061	0.132	0.058	0.871	0.051	0.062
Rel. limit of repeatability		22.81%	13.92%	52.94%	8.89%	38.21%	21.80%
Rel. limit of reproducibility		57.43%	47.12%	101.88%	83.79%	158.03%	40.60%
No. of laboratories after elimination of outliers		12	11	12	10	11	11
No. of measurement values without outliers		23	22	23	20	22	22

⁴ Type II method

COMPENDIUM OF INTERNATIONAL METHODS OF ANALYSIS - OIV
Method of determination of phthalates
by gas chromatography / mass spectrometry in wines

Table 7: Benzyl butyl phthalate (BBP)⁵ – Results of data evaluation

		S001	S002	S003	S004	S005	S006
No. of laboratories that submitted compliant results		11	10	11	10	10	11
Mean	mg/l	0.049	0.026	0.033	0.074	0.075	0.050
Median	mg/l	0.050	0.027	0.034	0.075	0.078	0.051
Assigned value	mg/l	0.057	0.029	0.037	0.088	0.087	0.053
Rel. dev. assign. value		-12.3%	-6.9%	-8.1%	-14.8%	-10.3%	-3.8%
Repeatability s.d.	mg/l	0.002	0.001	0.003	0.004	0.003	0.003
Reproducibility s.d.	mg/l	0.008	0.004	0.005	0.011	0.015	0.007
Rel. repeatability s.d.		4.30%	4.96%	8.08%	5.10%	3.31%	4.78%
Rel. reproducibility s.d.		13.71%	13.82%	13.93%	12.72%	17.00%	14.00%
Modified Horwitz s.d. **		22.00%	22.00%	22.00%	22.00%	22.00%	22.00%
HORRATR		0.62	0.63	0.63	0.58	0.77	0.64
Limit of repeatability, r (2.77 X sr)	mg/l	0.007	0.004	0.008	0.012	0.008	0.007
Limit of reproducibility, R (2.77 X sR)	mg/l	0.022	0.011	0.014	0.031	0.041	0.021
Rel. limit of repeatability		11.90%	13.75%	22.38%	14.14%	9.16%	13.23%
Rel. limit of reproducibility		37.98%	38.27%	38.58%	35.23%	47.09%	38.77%
No. of laboratories after elimination of outliers		9	8	10	9	9	10
No. of measurement values without outliers		17	15	19	18	18	20

⁵ Type II method

COMPENDIUM OF INTERNATIONAL METHODS OF ANALYSIS - OIV
Method of determination of phthalates
by gas chromatography / mass spectrometry in wines

Table 8: Dicyclohexyl phthalate (DCHP)⁶ – Results of data evaluation

		S001	S002	S003	S004	S005	S006
No. of laboratories that submitted compliant results		9	8	9	8	8	9
Mean	mg/l	0.079	0.042	0.030	0.088	0.046	0.031
Median	mg/l	0.076	0.044	0.033	0.091	0.050	0.033
Assigned value	mg/l	0.084	0.048	0.038	0.105	0.057	0.036
Rel. dev. assign. value		-9.5%	-8.3%	-13.2%	-13.3%	-12.3%	-8.3%
Repeatability s.d.	mg/l	0.005	0.006	0.003	0.005	0.002	0.001
Reproducibility s.d.	mg/l	0.024	0.008	0.005	0.011	0.011	0.006
Rel. repeatability s.d.		5.60%	13.13%	6.75%	4.84%	3.25%	3.67%
Rel. reproducibility s.d.		28.46%	16.05%	12.93%	10.20%	18.83%	16.37%
Modified Horwitz s.d. **		22.00%	22.00%	22.00%	22.00%	22.00%	22.00%
HORRATR		1.29	0.73	0.59	0.46	0.86	0.74
Limit of repeatability, r (2.77 X sr)	mg/l	0.013	0.017	0.007	0.014	0.005	0.004
Limit of reproducibility, R (2.77 X sR)	mg/l	0.066	0.021	0.014	0.030	0.030	0.016
Rel. limit of repeatability		15.53%	36.37%	18.69%	13.40%	9.00%	10.18%
Rel. limit of reproducibility		78.83%	44.46%	35.82%	28.24%	52.15%	45.35%
No. of laboratories after elimination of outliers		9	7	8	7	7	8
No. of measurement values without outliers		18	14	15	14	14	16

⁶ Type II method

COMPENDIUM OF INTERNATIONAL METHODS OF ANALYSIS - OIV
Method of determination of phthalates
by gas chromatography / mass spectrometry in wines

Table 9: Bis (2-ethylhexyl) phthalate (DEHP)⁷ – Results of data evaluation

		S001	S002	S003	S004	S005	S006
No. of laboratories that submitted compliant results		12	11	12	11	11	12
Mean	mg/l	0.101	0.028	0.602	0.150	0.741	1.032
Median	mg/l	0.099	0.026	0.654	0.180	0.709	1.115
Assigned value	mg/l	0.217	0.046	1.049	0.328	1.569	2.013
Rel. dev. assign. value		-54.4%	-43.5%	-37.7%	-45.1%	-54.8%	-44.6%
Repeatability s.d.	mg/l	0.017	0.005	0.206	0.016	0.122	0.266
Reproducibility s.d.	mg/l	0.019	0.011	0.238	0.063	0.465	0.563
Rel. repeatability s.d.		7.72%	11.54%	19.66%	4.82%	7.78%	13.20%
Rel. reproducibility s.d.		8.92%	24.15%	22.70%	19.11%	29.61%	27.96%
Modified Horwitz s.d. **		20.13%	22.00%	15.88%	18.92%	14.95%	14.40%
HORRATR		0.44	1.10	1.43	1.01	1.98	1.94
Limit of repeatability, r (2.77 X sr)	mg/l	0.046	0.015	0.571	0.044	0.338	0.736
Limit of reproducibility, R (2.77 X sR)	mg/l	0.054	0.031	0.660	0.174	1.287	1.559
Rel. limit of repeatability		21.39%	31.98%	54.45%	13.36%	21.54%	36.55%
Rel. limit of reproducibility		24.70%	66.91%	62.87%	52.93%	82.03%	77.46%
No. of laboratories after elimination of outliers		10	10	12	9	11	12
No. of measurement values without outliers		20	20	23	18	22	24

⁷ Type IV method

COMPENDIUM OF INTERNATIONAL METHODS OF ANALYSIS - OIV
Method of determination of phthalates
by gas chromatography / mass spectrometry in wines

Table 10: Di-n-octyl phthalate (DNOP)⁸ – Results of data evaluation

		S001	S002	S003	S004	S005	S006
No. of laboratories that submitted compliant results		11	10	11	10	9	10
Mean	mg/l	0.031	0.015	0.051	0.073	0.016	0.026
Median	mg/l	0.035	0.015	0.049	0.061	0.019	0.028
Assigned value	mg/l	0.086	0.031	0.059	0.114	0.036	0.054
Rel. dev. assign. value		-59.3%	-51.6%	-16.9%	-46.5%	-47.2%	-48.1%
Repeatability s.d.	mg/l	0.007	0.003	0.021	0.005	0.004	0.005
Reproducibility s.d.	mg/l	0.010	0.003	0.023	0.038	0.008	0.011
Rel. repeatability s.d.		7.84%	9.25%	36.33%	4.51%	11.18%	9.23%
Rel. reproducibility s.d.		11.50%	9.33%	38.90%	33.40%	23.32%	20.10%
Modified Horwitz s.d. **		22.00%	22.00%	22.00%	22.00%	22.00%	22.00%
HORRATR		0.52	0.42	1.77	1.52	1.06	0.91
Limit of repeatability, r (2.77 X sr)	mg/l	0.019	0.008	0.059	0.014	0.011	0.014
Limit of reproducibility, R (2.77 X sR)	mg/l	0.027	0.008	0.064	0.105	0.023	0.030
Rel. limit of repeatability		21.73%	25.61%	100.62%	12.50%	30.97%	25.56%
Rel. limit of reproducibility		31.85%	25.85%	107.76%	92.52%	64.60%	55.66%
No. of laboratories after elimination of outliers		9	8	10	9	7	8
No. of measurement values without outliers		18	15	18	16	14	16

⁸ Type IV method

COMPENDIUM OF INTERNATIONAL METHODS OF ANALYSIS - OIV
Method of determination of phthalates
by gas chromatography / mass spectrometry in wines

Table 11: Diisononyl phthalate (DINP)⁹ – Results of data evaluation

		S001	S002	S003	S004	S005	S006
No. of laboratories that submitted compliant results		9	8	10	8	8	9
Mean	mg/l	0.027	0.108	1.820	0.059	0.115	0.064
Median	mg/l	0.028	0.116	1.497	0.058	0.136	0.051
Assigned value	mg/l	0.054	0.242	3.134	0.104	0.271	0.057
Rel. dev. assign. value		-48.1%	-52.1%	-52.2%	-44.2%	-49.8%	-10.5%
Repeatability s.d.	mg/l	0.004	0.019	0.520	0.005	0.010	0.003
Reproducibility s.d.	mg/l	0.006	0.027	1.067	0.019	0.072	0.040
Rel. repeatability s.d.		8.14%	7.84%	16.60%	5.17%	3.83%	5.51%
Rel. reproducibility s.d.		10.27%	11.18%	34.06%	18.41%	26.60%	70.59%
Modified Horwitz s.d. **		20.00%	20.00%	20.00%	20.00%	20.00%	20.00%
HORRATR		0.51	0.56	1.70	0.92	1.33	3.53
Limit of repeatability, r (2.77 X sr)	mg/l	0.012	0.053	1.441	0.015	0.029	0.009
Limit of reproducibility, R (2.77 X sR)	mg/l	0.015	0.075	2.957	0.053	0.200	0.111
Rel. limit of repeatability		22.55%	21.71%	45.99%	14.32%	10.61%	15.27%
Rel. limit of reproducibility		28.44%	30.98%	94.35%	50.99%	73.69%	195.53%
No. of laboratories after elimination of outliers		5	6	9	7	6	6
No. of measurement values without outliers		10	11	17	13	12	12

⁹ Type IV method

COMPENDIUM OF INTERNATIONAL METHODS OF ANALYSIS - OIV
Method of determination of phthalates
by gas chromatography / mass spectrometry in wines

Table 12: Diisodecyl phthalate (DIDP)¹⁰ – Results of data evaluation

		S001	S002	S003	S004	S005	S006
No. of laboratories that submitted compliant results		8	7	8	7	7	8
Mean	mg/l	0.096	0.103	0.677	0.152	0.186	1.828
Median	mg/l	0.102	0.107	0.540	0.152	0.181	1.660
Assigned value	mg/l	0.275	0.186	0.200	0.281	0.427	3.070
Rel. dev. assign. value		-62.9%	-42.5%	170.0%	-45.9%	-57.6%	-45.9%
Repeatability s.d.	mg/l	0.009	0.018	0.477	0.048	0.027	0.202
Reproducibility s.d.	mg/l	0.025	0.018	0.505	0.058	0.109	1.676
Rel. repeatability s.d.		3.42%	9.61%	238.49%	17.11%	6.27%	6.57%
Rel. reproducibility s.d.		9.11%	9.61%	252.34%	20.51%	25.43%	54.59%
Modified Horwitz s.d. **		20.00%	20.00%	20.38%	20.00%	20.00%	20.00%
HORRATR		0.46	0.48	12.38	1.03	1.27	2.73
Limit of repeatability, r (2.77 X sr)	mg/l	0.026	0.050	1.321	0.133	0.074	0.559
Limit of reproducibility, R (2.77 X sR)	mg/l	0.069	0.050	1.398	0.160	0.301	4.642
Rel. limit of repeatability		9.46%	26.62%	660.61%	47.40%	17.37%	18.21%
Rel. limit of reproducibility		25.25%	26.62%	698.98%	56.82%	70.44%	151.21%
No. of laboratories after elimination of outliers		7	5	7	7	7	7
No. of measurement values without outliers		14	10	13	14	14	14

¹⁰ Type IV method

COMPENDIUM OF INTERNATIONAL METHODS OF ANALYSIS - OIV
Method of determination of phthalates
by gas chromatography / mass spectrometry in wines

6. References

Report on the Method Performance Study of a Method to Determine Phthalates in Wine Determination of Ten Phthalates in Wine by Gas Chromatography Mass Spectrometry (GC-MS), Wenzl Thomas, Karasek Lubomir, Giri Anupam. Publications Office of the European Union 2015 doi :10.2787/666948 (online) <https://publications.europa.eu/en/publication-detail/-/publication/b3ebef67-f1db-4fb2-97ce-bfc301c8ce68/language-en>

Method OIV-MA-AS323-11

Type IV methods

Method for the determination of potassium polyaspartate in
wine by high-performance liquid chromatography coupled
with a fluorescence detector
OIV-OENO 619-2019

1. SCOPE OF APPLICATION

This method is applicable to the analysis of potassium polyaspartate (KPA) in wines at concentrations higher than 40 mg/L.

2. PRINCIPLE

The procedure consists of carrying out the determination of aspartic acid in wine before and after acid hydrolysis, by derivatisation with ortho-phthalaldehyde (OPA) followed by chromatographic analysis coupled with a fluorescence detector. The difference in the aspartic acid content between the hydrolysed sample and non-hydrolysed sample will indicate the level of addition of polyaspartate.

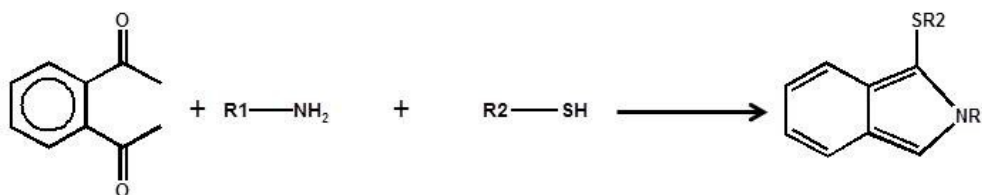

Ortho-phthalaldehyde (OPA)
R1-NH₂: aspartic acid
R2-SH: mercaptoethanol

Derivatised AA

3. REAGENTS AND PRODUCTS

COMPENDIUM OF INTERNATIONAL METHODS OF ANALYSIS-OIV
Method for the determination of potassium polyaspartate in wine by
high-performance liquid chromatography coupled
with a fluorescence detector

Use ultra-pure water (EN ISO 3696 Grade 3 or double-distilled water)

For acid hydrolysis:

3.1. 10 g/L Sodium metabisulphite ($\text{Na}_2\text{S}_2\text{O}_5$, CAS No.: 7681-57-4) solution: weigh 5 grams of sodium metabisulphite into a 500-mL Class A flask and make up to the mark with ultra-pure water.

3.2. 6 M Hydrochloric acid (HCl, CAS No.: 7647-01-0)

3.3. 5 M Sodium hydroxide (NaOH, CAS No.: 1310-73-2)

Standard solutions:

3.4. Aspartic acid (DL-aspartic acid $\text{C}_4\text{H}_7\text{NO}_4$, purity $\geq 99\%$, CAS No.: 617-45-8)

3.4.1. Stock solution 1: solution of 8000 mg/L aspartic acid in ultra-pure H_2O

3.4.2. Stock solution 2: solution of 200 mg/L aspartic acid in ultra-pure H_2O

3.5. Aminocaproic acid ($\text{C}_6\text{H}_{13}\text{NO}_2$, purity $\geq 99\%$, CAS No.: 60-32-2)

3.5.1. Stock solution of aminocaproic acid at 1000 mg/L in ultra-pure H_2O (internal standard)

Calibration solutions prepared through dilution of stock solutions 1 and 2 in double-distilled H_2O . The reference values are as follows:

- **2 mg/L STD1**: take 0.200 mL of stock solution 2 (3.4.2.) and make up to the mark in a 20-mL flask with ultra-pure H_2O

- **10 mg/L STD2**: take 1.000 mL of stock solution 2 (3.4.2.) and make up to the mark in a 20-mL flask with ultra-pure H_2O

- **50 mg/L STD3**: take 5.000 mL of stock solution 2 (3.4.2.) and make up to the mark in a 20-mL flask with ultra-pure H_2O

- **100 mg/L STD4**: take 0.250 mL of stock solution 1 (3.4.1.) and make up to the mark in a 20-mL flask with ultra-pure H_2O

- **250 mg/L STD5**: take 0.625 mL of stock solution 1 (3.4.1.) and make up to the mark in a 20-mL flask with ultra-pure H_2O

- **500 mg/L STD6**: take 1.250 mL of stock solution 1 (3.4.1.) and make up to the mark in a 20-mL flask with ultra-pure H_2O

Derivatising solution:

3.6. Sodium tetraborate decahydrate (solid, purity $> 99\%$, CAS No. 1303-96-4)

3.6.1. 0.1 M Sodium tetraborate decahydrate buffer solution with a pH of 10.5: dissolve 19.1 g sodium tetraborate and make up to the mark in a 500-mL flask with ultra-pure water. Check the pH value.

3.7. Ortho-phthalaldehyde (OPA) ($\text{C}_8\text{H}_6\text{O}_2$, purity $\geq 99\%$, CAS No.: 643-79-8)

3.8. Mercaptoethanol ($\text{C}_2\text{H}_6\text{OS}$, purity $\geq 99\%$, CAS No.: 60-24-2)

COMPENDIUM OF INTERNATIONAL METHODS OF ANALYSIS-OIV
Method for the determination of potassium polyaspartate in wine by
high-performance liquid chromatography coupled
with a fluorescence detector

3.9. Derivatising solution: add 100 mg OPA, 200 µL mercaptoethanol and 1 mL methanol to a 10 mL-flask and make up to the mark with the 0.1 M sodium tetraborate decahydrate buffer solution with a pH of 10.5. The solution should be prepared just before use.

Mobile phases for HPLC:

3.10. HPLC-grade methanol (liquid)

3.11. HPLC-grade tetrahydrofuran (liquid)

3.12. Anhydrous sodium acetate (CAS No.: 127-09-3)

3.12.1. 0.05 M Sodium acetate buffer solution: dissolve 2.05 g anhydrous sodium acetate and make up to the mark in a calibrated 500-mL flask with ultra-pure water.

3.13. HPLC-grade acetonitrile (CH₃CN) (liquid)

3.14. Ultra-pure water (e.g. EN ISO 3696 Grade 3 or double-distilled water)

3.15. Mobile phase:

- [eluent A]: ultra-pure water,
- [eluent B]: 0.05 M sodium acetate / tetrahydrofuran (96:4) buffer solution,
- [eluent C]: methanol,
- [eluent D]: acetonitrile.

4. EQUIPMENT AND APPARATUS

Unless otherwise specified, the glassware required to prepare the solutions should be class A.

4.1. Hot plate

4.2. 4-mL Tinted-glass vial with screw cap

4.3. 0.100-1.000-mL Micropipette

4.4. Cellulose-acetate-membrane syringe filter with porosity of 0.20 µm

4.5. Precision balance

4.6. Calibrated flasks

4.7. HPLC system that includes a quaternary pump, automatic sampler, compartment with thermostat for the column and FLD

4.8. Column: polar endcapped C18 (e.g. Synchronis aQ 4.6 x 250 mm; 5 µm)

5. PROCEDURE

The procedure is divided into three phases: hot acid hydrolysis of the wine sample; the process of preparation of the samples (both of the calibration solutions and of the wines before and after hydrolysis), which are analysed by HPLC-FLD to determine the aspartic acid concentration; and HPLC-FLD analysis.

COMPENDIUM OF INTERNATIONAL METHODS OF ANALYSIS-OIV
Method for the determination of potassium polyaspartate in wine by
high-performance liquid chromatography coupled
with a fluorescence detector

Phase 1: Acid hydrolysis

- Pour the following successively into a 4-mL tinted-glass vial with screw cap (4.2.):
- 0.2 mL solution of 10 g/L sodium metabisulphite (3.1.),
- 2 mL wine sample,
- 2 mL 6 M HCl (3.2.);
- heat to 108 °C (± 2 °C) on a hot plate for 72 hours;
- pour into a 10-mL flask, add 2.5 mL 5 M NaOH (3.3.) and make up to the mark with ultra-pure water.

The verification of the acid hydrolysis process is detailed in paragraph 6.

Phase 2: Preparation for HPLC analysis

The method envisages a derivatisation reaction of aspartic acid with ortho-phthalaldehyde (OPA).

To prepare the samples for analysis by HPLC, proceed as follows:

Calibration solutions and wine samples before hydrolysis:

- take a 1 mL sample of the solution for analysis and micro-filter (0.20 μ m filter) it into a 20-mL flask,
- add 0.2 mL internal standard (3.5.1.),
- make up to the mark with ultra-pure water.

Samples after hydrolysis:

- take a 5 mL sample of the solution for analysis and micro-filter (0.20 μ m filter) it into a 20-mL flask,
- add 0.2 mL internal standard (3.5.1.),
- make up to the mark with ultra-pure water.

Phase 3: HPLC analysis

The instrumental parameters for analysis by HPLC-FLD, for example, are as follows:

Oven temperature: 40 °C

Injection: 10 μ L

FLD Wavelength (λ): λ_{ex} = 340 nm; λ_{em} = 450 nm

The separation is conducted in gradient mode (see the eluents in point 3.15.):

COMPENDIUM OF INTERNATIONAL METHODS OF ANALYSIS-OIV
Method for the determination of potassium polyaspartate in wine by
high-performance liquid chromatography coupled
with a fluorescence detector

Time	%B	%C	%D	Flow
0.00	100.0	0.0	0.0	1.1
3.00	100.0	0.0	0.0	1.1
15.00	50.0	25.0	25.0	1.1
17.00	84.0	8.0	8.0	1.1
18.00	100.0	0.0	0.0	1.1
Stop time: 21 min + 2 min post time				

The following is an example of the automated derivatisation mode with an autosampler:

- Reagent positions in the autosampler:
 - position 1: methanol,
 - position 3: OPA,
 - position 4: empty vial,
 - position 11: ultra-pure water.

- Derivatisation phases:
 - draw 2.0 µL from the air,
 - draw 20.0 µL from vial 1,
 - transfer 20.0 µL into vial 4,
 - draw 5.0 µL from the sample,
 - transfer 5.0 µL into seat,
 - draw 0.0 µL from vial 1 (to clean the outside of the needle),
 - draw 5.0 µL from vial 3,
 - transfer 5.0 µL into seat,
 - mix 10.0 µL in seat, 10 times,
 - wait 0.50 min,
 - inject.

If the results obtained are higher than the calibration curve limit, dilute the sample as appropriate and perform the test again.

COMPENDIUM OF INTERNATIONAL METHODS OF ANALYSIS-OIV
Method for the determination of potassium polyaspartate in wine by
high-performance liquid chromatography coupled
with a fluorescence detector

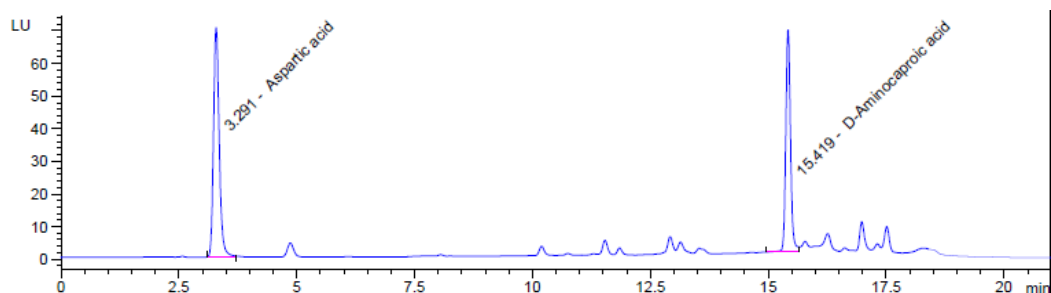

Chromatogram derived from a red wine

6. QUALITY CONTROL

For each series of analyses, quality control should be carried out through analysis of a wine sample to which 100 mg/L aspartic acid is added.

The sample, prepared according to point 5, is analysed at the beginning of the series. The results obtained, given in terms of the percentage yield, are recorded on a control chart.

7. METHOD CHARACTERISTICS: INTRA-LABORATORY VALIDATION PARAMETERS

- Linearity

Non-hydrolysed, non-derivatised calibration solutions of known concentration are used to simulate the entire analytical process. Each sequence, to be acceptable, should contain calibration curves with an $R^2 > 0.990$ (Figure 1).

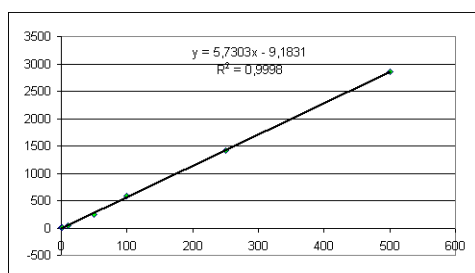

Figure 1

- Recovery and matrix effect

Aqueous solutions:

The recovery rate for the processes of acid hydrolysis and derivatisation is verified through comparison of the pre-hydrolysis and post-hydrolysis aqueous stock solutions of aspartic acid. Three solutions of known concentration (25, 100 and 200 mg/L) were prepared; the data obtained is shown in the following table:

COMPENDIUM OF INTERNATIONAL METHODS OF ANALYSIS-OIV
Method for the determination of potassium polyaspartate in wine by
high-performance liquid chromatography coupled
with a fluorescence detector

	Test 1	Test 2	Test 3
Before hydrolysis (mg/L)	25.4	109	213
After hydrolysis (mg/L)	25.2	108	213
Recovery rate (%)	99.2	99.1	100

Wine:

The method of standard additions to white wine and red wine was applied (50 mg/L and 200 mg/L potassium polyaspartate gradual additions to verify matrix interference in the determination of KPA). For each level, 5 repeatability tests were carried out.

	Red wine w/o addition (mg/L)	Red wine + 50 mg/L	Red wine + 200 mg/L	White wine w/o addition (mg/L)	White wine + 50 mg/L	White wine + 200 mg/L
Repetitions (in Asp. Ac.)	84.0	123.9	258.2	121.9	164.6	294.2
	85.4	127.3	259.4	123.2	163.3	291.5
	83.8	125.1	250.2	121.9	170.3	291.3
	87.7	124.4	253.5	119.5	161.9	284.8
	83.2	126.1	256.9	123.3	160.0	287.4
Mean (in Asp. Ac.)	84.8	125.4	255.6	122.0	164.0	289.8
S_r (in Asp. Ac.)	1.8	1.4	3.8	1.5	3.9	3.7
Mean (in added KPA)	-	46.6	196.3	-	48.3	193.0
S_r (in added KPA)	-	2.8	5.0	-	4.9	3.8
Horrat r	-	0.99	0.52	-	1.71	0.48
Theoretical KPA	-	50	200	-	50	200
Rec KPA %	-	93	98	-	94	96

COMPENDIUM OF INTERNATIONAL METHODS OF ANALYSIS-OIV
Method for the determination of potassium polyaspartate in wine by
high-performance liquid chromatography coupled
with a fluorescence detector

- S_r (in Asp. Ac.): standard deviation of repeatability tests expressed in aspartic acid
- S_r (in KPA): standard deviation of repeatability tests expressed in KPA
- Rec KPA %: recovery expressed in KPA

The recovery should be within the range of 80-110%.
 The repeatability meets the Horrat criterion.

Limits of detection and quantification:

Considering that the wine naturally contains aspartic acid, the decision was made to determine the LoD and LoQ based on the signal-to-noise ratio determined for the wine samples.

<i>CALCULATION OF THE LIMITS OF DETECTION AND QUANTIFICATION</i>		
CASE N°3: THE SIGNAL-TO-NOISE (S/N) RATIO IS KNOWN FOR A LOW CONCENTRATION		
C	24.74	Value of the wine sample concentration
S/N	122.5	Signal-to-noise ratio
LoD	0.7	Limit of detection
LoQ	2.1	Limit of quantification (3 x LoD)

8. CALCULATION AND EXPRESSION OF RESULTS

The aspartic acid concentration in milligrams per litre (mg/L) present in the samples is calculated through the acquisition programme's processor.

The quantity of potassium polyaspartate (KPA) added is obtained through the difference between the sample subjected to hydrolysis and the non-hydrolysed sample without addition:

$$KPA(mg/L) = (AsparticAcid_{hydrolysed\ wine} - AsparticAcid_{wine\ w/o\ addition}) \cdot f_{KPA}$$

where f_{KPA} is the factor of conversion of potassium polyaspartate into aspartic acid, calculated from the ratio of the molecular mass of the potassium polyaspartate monomer to that of aspartic acid, according to the following equation:

$$f_{KPA} = \frac{MM_{KPA_monomer}}{MM_{aspartic_acid}} = 1.15$$

COMPENDIUM OF INTERNATIONAL METHODS OF ANALYSIS-OIV
Method for the determination of potassium polyaspartate in wine by
high-performance liquid chromatography coupled
with a fluorescence detector

The results are expressed in mg/L to 1 significant figure.

9. BIBLIOGRAPHY

- OIV-MA-AS1-10 (OENO 7/2000)

**COMPENDIUM OF INTERNATIONAL METHODS OF ANALYSIS – OIV
Simultaneous analysis of iron, copper, potassium, calcium and
manganese in wines, using MP/AES (microwave-induced plasma
atomic emission spectrometry)**

Method OIV-MA-AS323-12

Type IV Method

**Simultaneous analysis of iron, copper, potassium, calcium
and manganese in wines, using MP/AES (microwave-induced
plasma atomic emission spectrometry)**

(Resolution OIV-OENO 637-2021)

1 Scope of application

This Type IV method, based on nitrogen plasma atomic emission spectrometry, makes it possible to simultaneously determine the following elements in wines.

Copper	0.05-1 mg·L ⁻¹
Iron	1-10 mg·L ⁻¹
Potassium	15-1200 mg·L ⁻¹
Calcium	1-100 mg·L ⁻¹
Manganese	0.25-4 mg·L ⁻¹

Where necessary, it is the responsibility of each laboratory using this method to redefine, and potentially widen, the scope of application via a validation study.

2 References

- ISO 78-2: Chemistry – Layouts for standards.
- ISO 3696: Water for analytical laboratory use.
- Resolution OIV OENO 418-2013.

**COMPENDIUM OF INTERNATIONAL METHODS OF ANALYSIS – OIV
Simultaneous analysis of iron, copper, potassium, calcium and
manganese in wines, using MP/AES (microwave-induced plasma
atomic emission spectrometry)**

3 Principle

Microwave-induced plasma atomic emission spectrometry (MP-AES) is a spectroscopic elemental method of analysis that works on the principle of atomic emission, with optical detection.

The sample, in liquid form, is introduced into a concentric nebuliser where an aerosol of the sample is generated via a double-pass cyclonic spray chamber and then introduced into the centre of the plasma using the plasma torch. The plasma is generated using a wave guide that focuses and maintains the microwave energy around the torch. The sample is thus desolvated, atomised and ionised, resulting in excitation of the atoms and ions, which are then transferred into the monochromator optical system.

The CCD detector enables simultaneous analysis of the background and signal for greater precision of analysis.

This apparatus functions with nitrogen plasma generated from compressed air and thus makes it possible to reduce the operational costs compared with other spectroscopy techniques for elemental analysis (ICP or AA).

4 Reagents and solutions

Unless otherwise specified, only reagents of recognised analytical quality should be used.

**COMPENDIUM OF INTERNATIONAL METHODS OF ANALYSIS – OIV
Simultaneous analysis of iron, copper, potassium, calcium and
manganese in wines, using MP/AES (microwave-induced plasma
atomic emission spectrometry)**

- 4.1 Ultra-pure, demineralised water with resistivity $\geq 18 \text{ M}\Omega$ (ISO standard 3696)
- 4.2 Mono or multi-elementary solution(s) (at 1000 or 10,000 $\text{mg}\cdot\text{L}^{-1}$), for the mineral elements analysed (Ca, Cu, Fe, K and Mn) and for the indium (In) used as an internal control. Use certified solutions when possible.
- 4.3 Internal control (by way of example): prepared mono- or multi-elementary synthetic solutions, and a control wine for which the target values have been obtained under reliable conditions (certified wine, or wine derived from an inter-laboratory comparison programme).
- 4.4 Nitric acid at over 60% (w/w), for trace analysis (CAS No. 7697-37-2)
- 4.5 Ethanol at over 99% purity (v/v) (CAS No. 64-17-5)
- 4.6 Cesium chloride at over 99% purity (w/w) (CAS No. 7647-17-8)

5 Apparatus and equipment

- 5.1 Atomic emission spectrometer coupled with nitrogen microwave plasma (MP-AES)

Note: The MP-AES can be equipped with a loop for transfer of the sample to increase the life cycle of the consumables (nebuliser and plasma torch). This system carries out rinsing with nitric acid at the sample input channels to the spray chamber. This reduces both the quantity of sample introduced into the nebuliser and the wear level of the equipment.

**COMPENDIUM OF INTERNATIONAL METHODS OF ANALYSIS – OIV
Simultaneous analysis of iron, copper, potassium, calcium and
manganese in wines, using MP/AES (microwave-induced plasma
atomic emission spectrometry)**

5.2 Multi-channel micropipettes suitable for taking variable volumes

5.3 Class A volumetric flasks

6 Preparation of the sample

6.1 Example preparation of the calibration range

Quantification is carried out by external calibration using calibration solutions, making it possible to establish 5-point calibration curves.

The calibration solutions are adjusted to 12% v/v ethanol and 0.2% v/v nitric acid.

Example calibration range:

mg·L ⁻¹	S0	S1	S2	S3	S4	S5
Cu	0	0.1	0.25	0.5	0.75	1
Fe	0	1	2.5	5	7.5	10
K	0	400	600	800	1000	1200
Ca	0	10	25	50	75	100
Mn	0	0.5	1	2	3	4

6.2 Inline dilution of the samples

The calibration range as well as the samples to be analysed are diluted in line to a dilution factor of 1:2, using a simple Y-shaped device placed at the output of the peristaltic pump. The sample (channel 1) is diluted using nitric acid solution at 0.2% indium (600 mg.L⁻¹) and cesium chloride (0.3 g.L⁻¹) (channel 2). Indium is used as a control of stability throughout the analytical sequence, therefore its intensity is measured for all the analysed solutions.

This dilution makes it possible to limit the effects of saturation, in particular on potassium. Nitric acid produces a minor mineralisation effect, which, though only partial, facilitates the passage of organic compounds into the plasma.

**COMPENDIUM OF INTERNATIONAL METHODS OF ANALYSIS – OIV
Simultaneous analysis of iron, copper, potassium, calcium and
manganese in wines, using MP/AES (microwave-induced plasma
atomic emission spectrometry)**

Safety precautions – *When handling acids, operators should protect their hands and eyes. Acids must be handled under a suitable hood.*

7 Procedure

The parameters used to achieve the performance described in point 8 are as follows:

7.1 Instrumental parameters

The following description refers to an MP-AES instrument and provides example analytical conditions. Changes may be made by the laboratory as needed.

Instrumental parameter	Specifications
Nebuliser	OneNeb inert concentric
Spray chamber	Double-pass cyclonic
Tubing for the sample	Black-black (average flow rate 0.25 mL/min)
Tubing for the diluent (HNO ₃ at 0.2%)	Black-black (average flow rate 0.25 mL/min)
Outlet tubing	Blue-blue (average flow rate 1 mL/min)
Sampling duration	20 s
Stabilisation duration	15 s
Rinsing duration	15 s
Pump speed	15 rpm
Number of replicates	3
AVS4 valve	Specifications
Pump speed	10 rpm
Sampling time	20 s (speed: rapid)
Commutation time	18 s
Flush time	15 s (speed: rapid)
Stabilisation duration	20 s
Number of replicates	3

**COMPENDIUM OF INTERNATIONAL METHODS OF ANALYSIS – OIV
Simultaneous analysis of iron, copper, potassium, calcium and
manganese in wines, using MP/AES (microwave-induced plasma
atomic emission spectrometry)**

7.2 Acquisition parameters

	Copper	Calcium	Iron	Potassium	Manganese	Indium
Reading duration	3 seconds					
Visualisation position	0	10	0	20	0	0
Nebulisation flow rate	0.5 mL/min	0.95 mL/min	0.55 mL/min	0.9 mL/min	0.65 mL/min	0.75 mL/min
Air injection rate	Average					High
Background correction	Automatic					
Calibration adjustment	Rational					/
Analysis wavelength	327.395 nm	445.478 nm	371.993 nm	404.414 nm	403.076 nm	325.600 nm

8 Expression of results

The results are expressed in mg.L⁻¹ of element analysed, and the number of decimal places depends on the method performance for the element in question. Therefore, copper and manganese are expressed to 2 decimal places, iron to 1 decimal place, and potassium and calcium to the nearest unit of measurement, in accordance with the measurement uncertainties and limits of quantification of the method.

**COMPENDIUM OF INTERNATIONAL METHODS OF ANALYSIS – OIV
Simultaneous analysis of iron, copper, potassium, calcium and
manganese in wines, using MP/AES (microwave-induced plasma
atomic emission spectrometry)**

9 Annex: Example internal validation

Performance evaluation and validation were carried out according to the practical guide for the validation, quality control, and evaluation of a usual oenological method of analysis (Resolution OIV-OENO 418-2013).

9.1 Data acquisition

A total of 7 reference materials (ERM, doped samples and/or synthetic solutions) distributed across the range covering the scope of application of the methods in terms of concentration were used. These materials were analysed in $n = 5$ series under reproducibility conditions and within the stability time of the material for the parameter considered. For each material and each series, $p = 2$ repetitions were carried out. In the absence of RM, synthetic solutions composed of 12% ethanol and 0.2% nitric acid may be used.

9.2 Precision results

**Copper 327.395 nm
(mg.L⁻¹)**

Precision	Material 1 (rosé wine)	Material 2 (red wine)	Material 3 (rosé wine)	Material 4 (red wine)	Material 5 (sparkling white wine)	Material 6 (white wine)
Target value	0.05	0.15	0.25	0.5	0.75	1.0
Sr	0.0008	0	0.0032	0.0095	0.01	0.05
r	0.002	0	0.00885	0.02656	0.029	0.137
s _I	0.0015	0.00548	0.01500	0.01500	0.025	0.051
%CV (k=2)	6.27	7.11	12.88	6.01	6.66	9.96

Where Sr is the repeatability standard deviation, r is the repeatability, S_I the intermediate precision standard deviation and %CV the wider precision coefficient of variation.

COMPENDIUM OF INTERNATIONAL METHODS OF ANALYSIS – OIV
Simultaneous analysis of iron, copper, potassium, calcium and manganese in wines, using MP/AES (microwave-induced plasma atomic emission spectrometry)

Iron 371.993 nm
(mg.L⁻¹)

Precision	Material 1 (synthetic solution)	Material 2 (red wine)	Material 3 (sparkling white wine)	Material 4 (rosé wine)	Material 5 (red wine)	Material 6 (red wine)	Material 7 (white wine)
Target value	1	1.5	2	2.3	5	7.5	10
Sr	0.078	0	0.045	0.032	0.109	0.145	0.212
r	0.217	0	0.125	0.088	0.307	0.406	0.255
sI	0.106	0.055	0.088	0.122	0.294	0.280	0.415
%CV (k=2)	24.11	6.68	8.63	10.51	11.56	7.19	8.06

Potassium 404.414 nm
(mg.L⁻¹)

Precision	Material 1 (synthetic solution)	Material 2 (rosé wine)	Material 3 (sparkling white wine)	Material 4 (white wine)	Material 5 (red wine)	Material 6 (synthetic solution)	Material 7 (red wine)
Target value	15	363	404.5	675	800	1000	1253
Sr	0.4	5.0	2.8	6.0	4.0	5.6	10.8
r	1.2	14.0	7.9	16.8	11.2	15.7	13.0
sI	1.0	16.0	19.3	33.5	22.7	41.6	37.1
%CV (k=2)	13.94	8.54	8.79	9.08	5.34	7.87	5.45

Calcium 445.478 nm
(mg.L⁻¹)

Precision	Material 1 (synthetic solution)	Material 2 (synthetic solution)	Material 3 (White wine)	Material 4 (sparkling white wine)	Material 5 (red wine)	Material 6 (white wine)	Material 7 (rosé wine)
-----------	------------------------------------	------------------------------------	----------------------------	--------------------------------------	--------------------------	----------------------------	---------------------------

**COMPENDIUM OF INTERNATIONAL METHODS OF ANALYSIS – OIV
Simultaneous analysis of iron, copper, potassium, calcium and
manganese in wines, using MP/AES (microwave-induced plasma
atomic emission spectrometry)**

Target value	0.5	1	6.8	27.5	54	68	100
Sr	0.08	0.03	0.07	0.32	0.83	0.41	0.86
r	0.23	0.09	0.20	0.90	2.33	1.16	0.15
sI	0.14	0.089	0.15	1.49	2.00	2.06	3.28
%CV (k=2)	68.59	15.33	4.81	10.59	6.67	6.01	6.64

**Manganese 403.076 nm
(mg.L⁻¹)**

Precision	Material 1 (synthetic solution)	Material 2 (red wine)	Material 3 (Rosé wine)	Material 4 (red wine)	Material 5 (sparkling white wine)	Material 6 (rosé wine)	Material 7 (white wine)
Target value	0.25	0.54	0.67	1.34	2	3	4
Sr	0.019	0.008	0.006	0.012	0.015	0.016	0.020
r	0.054	0.023	0.018	0.034	0.042	0.045	0.017
sI	0.023	0.011	0.021	0.028	0.051	0.092	0.153
%CV (k=2)	17.46	3.69	5.63	3.67	4.78	5.68	7.22

9.3 Trueness of the method

Accuracy profiles are established, graphically.

COMPENDIUM OF INTERNATIONAL METHODS OF ANALYSIS – OIV
Simultaneous analysis of iron, copper, potassium, calcium and manganese in wines, using MP/AES (microwave-induced plasma atomic emission spectrometry)

Accuracy profile
 Copper 327.395 nm (mg/L)

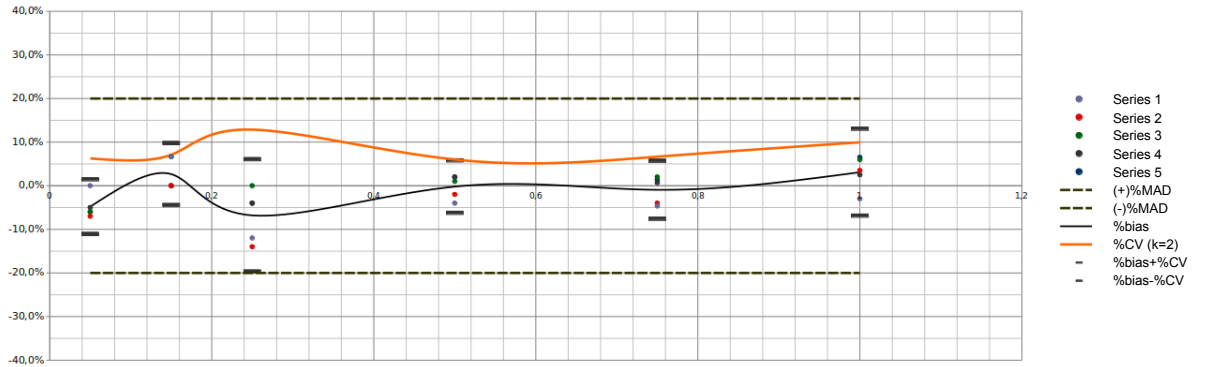

Accuracy profile
 Iron 371.993 nm (mg/L)

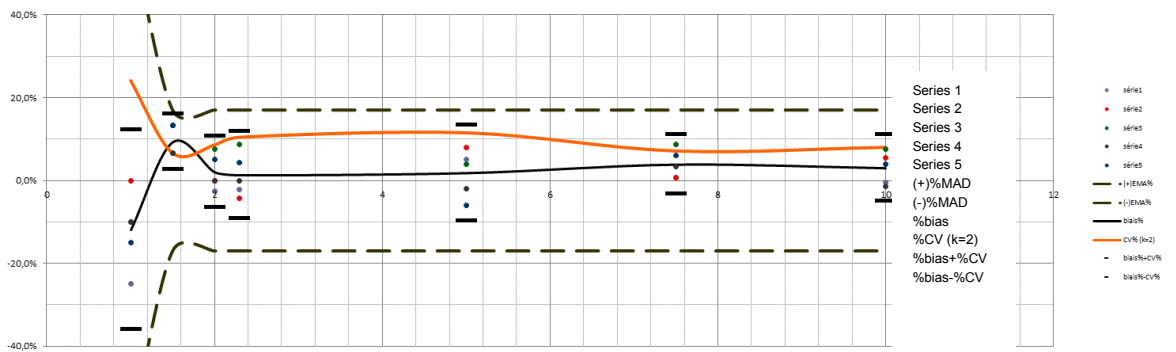

Accuracy profile
 Potassium 404.414 nm (mg/L)

COMPENDIUM OF INTERNATIONAL METHODS OF ANALYSIS – OIV
Simultaneous analysis of iron, copper, potassium, calcium and manganese in wines, using MP/AES (microwave-induced plasma atomic emission spectrometry)

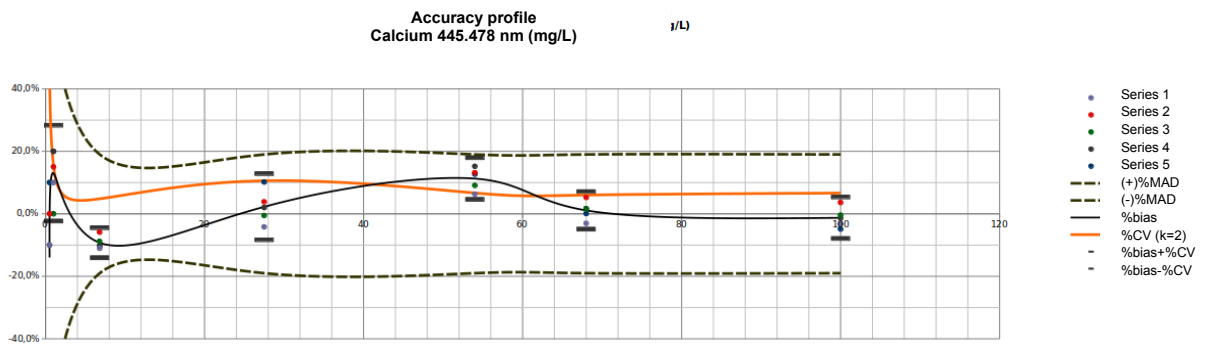
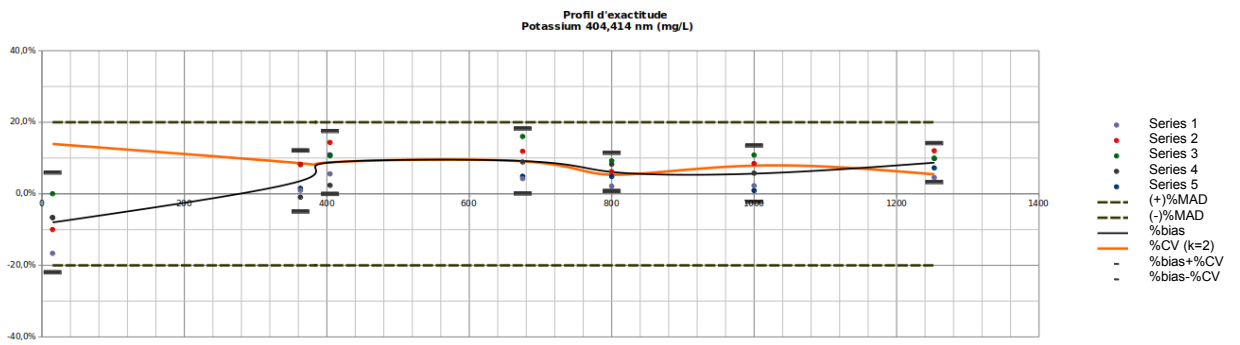

COMPENDIUM OF INTERNATIONAL METHODS OF ANALYSIS – OIV
Simultaneous analysis of iron, copper, potassium, calcium and manganese in wines, using MP/AES (microwave-induced plasma atomic emission spectrometry)

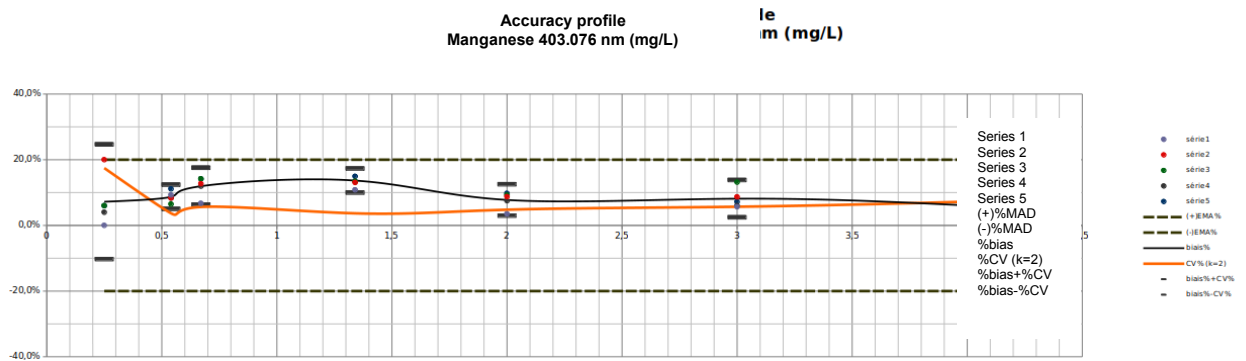

The verification of the trueness is carried out, for each concentration level, by comparing the interval produced by the intermediate precision around the value measured ($CV_{\text{precision}}$) with the interval of the MAD (Maximum Acceptable Deviation) around the reference value of the material. The trueness is accepted if the $CV_{\text{precision}}$ falls within the MAD. With regard to the MAD, the trueness tests are validated for all of the elements studied.

**COMPENDIUM OF INTERNATIONAL METHODS OF ANALYSIS – OIV
Simultaneous analysis of iron, copper, potassium, calcium and
manganese in wines, using MP/AES (microwave-induced plasma
atomic emission spectrometry)**

9.4 Limits of quantification

The limits of quantification (LOQ) are established by studying the range close to the low limit values. The value tested for the LOQ is validated if its %CV (k=2) < 60% (Resolution OIV-OENO 418-2013).

The following LOQ were validated:

mg.L ⁻¹	Method LOQ
Copper	0.05
Iron	1
Potassium	15
Calcium	1
Manganese	0.25

Microbiological Analysis of Wines and Musts

Detection, Differentiation and Counting of Micro-organisms

(Resolution OIV-Oeno 206/2010)

Objective:

Microbiological analysis is aimed at following alcoholic fermentation and/or malolactic fermentation and detecting microbiological infections, and allowing the detection of any abnormality, not only in the finished product but also during the different phases of manufacture.

Comments:

All experiments must be carried out under normal microbiological aseptic conditions, using sterilized material, close to a Bunsen burner flame or in a laminar flow room and flaming the openings of pipettes, tubes, flasks, etc. Before carrying out microbiological analysis, it is necessary to ensure that the samples to be analyzed are taken correctly.

Field of application:

Microbiological analysis can be applied to wines, musts, mistelles and all similar products even when they have been changed by bacterial activity. These methods may also be used in the analysis of industrial preparations of selected microorganisms, such as dry active yeasts and lactic bacteria.

Microbiological analysis techniques:

- 1. Reagents and materials**
- 2. Installations and equipment**
- 3. Sampling**
- 4. Quality tests**
 - 4.1 objective**
 - 4.2 principle**
 - 4.3 procedure**
 - 4.3.1 air quality tests**
 - 4.3.2 incubator quality tests**
- 5. Microscopic techniques for the detection, differentiation of micro-organisms and direct counting of yeasts**
 - 5.1. *Microscopic examination of liquids or deposits*
 - 5.2. *Gram staining for the differentiation of bacteria isolated from colonies (see paragraph 6)*
 - 5.3. *Catalase Test for the differentiation of bacteria isolated from colonies (see paragraph 6)*
 - 5.4. *Yeast cell count – haemocytometry*

5.5. *Yeast cell count – methylene blue staining of yeast cells*

6. Counting of micro-organisms by culture

6.1 *Detection, differentiation and enumeration of microorganisms (plate count)*

6.2. *Culture in liquid environment - "Most Probable Number" (MPN).*

1. REAGENTS AND MATERIALS

Current laboratory equipment and apparatus, as listed in ISO 7218:2007 - Microbiology of food and animal feeding stuff - General rules for microbiological examinations.

The following ones are recommended:

- Common laboratory materials and glassware, sterile (sterilized or ready-to-use sterile).
- Tubes (16x160 mm or similar) containing 9 ml sterile peptone water (Tryptone: 1 g/l) or other diluents to be used for serial sample dilutions.
- Ethanol to flame spreaders and tweezers.
- Hydrogen peroxide 3% solution.
- Micropipette holding sterile tips: 1 ml and 0.2 ml.
- L-shaped or triangular-shaped bent glass rods (hockey sticks) or plastic spreaders.
- Stainless steel tweezers, with flat edges.
- Sterile cellulose ester membranes (or equivalent) porosity 0.2 and 0.45 μm , 47 mm or 50 mm diameter, possibly with a printed grid on the surface, and packed singularly.
- Sterile cylinders.
- 10 ml sterile pipettes.

2. INSTALLATIONS AND EQUIPMENT

Current laboratory equipment and apparatus, as listed in ISO 7218:2007 - Microbiology of food and animal feeding stuff - General rules for microbiological examinations.

The following ones are recommended:

- Microbiological cabinet or laminar flow cabinet. In the absence of this device, work in the proximity (within 50 cm) of a gas burner.
- Balance, with an accuracy of ± 0.01 g.
- Autoclave.
- Incubator with settings ranging from 25°C to 37°C.
- pH meter, with an accuracy of $\pm 0,1$ pH units and a minimum measuring threshold of $\pm 0,01$ pH units.

- Refrigerator(s), set at $5 \pm 3^{\circ}\text{C}$, and freezer(s), which temperature shall be below -18°C , preferably equal to $-24 \pm 2^{\circ}\text{C}$.
- Thermostatically controlled bath, set at $45 \pm 1^{\circ}\text{C}$
- Microwave oven.
- Optical microscope.
- Gas burner.
- Colony-counting device.
- Equipment for culture in a modified atmosphere (a sealed jar in which anaerobiosis can be made).
- Filtering apparatus with 47 mm or 50 mm diameter filters.
- "Vortex" stirrer or equivalent.
- Incubator for dry heat sterilisation
- Centrifuge
- Pump

3. SAMPLING

The sample must reproduce the microbiology of the whole mass of must or wine to be analyzed. As far as possible, the mass must be homogenized before sampling, in order to resuspend microorganisms that tend to set down to the bottom of the container. In case the homogenization is undesirable, samples must be taken from where the microorganisms are likely (or suspected) to be present (i.e. when searching for yeasts lying in the bottom of tanks or barrels), but in this case results are not quantitative. Before taking a sample from a tap, this latter must be flamed, and 2-3 litres liquid must be flushed. The sample must be put in a sterile.

The sample must be kept refrigerated and analysed as quickly as possible.

The following amounts of samples are required for the microbiological examination:

Must, or fermenting must or wine in storage:	not less than 250 ml;
Bottled or packed wine:	not less than one unit, whatever the capacity;

4. QUALITY TESTS

4.1 Objective

These tests are aimed at detecting the risk of microbial infection in advance.

4.2 Principle

This technique is based on organoleptic and appearance changes (clouds, films, deposits, unusual colors) shown by wine when subjected to certain aeration and temperature conditions which can bring about microbiological activity. The nature of the changes should be confirmed by microscopic examination.

4.3 Operating method

4.3.1 Air quality tests

A 50 mL wine sample after filtration on coarse sterile filter paper is placed in a 150 mL sterile conical flask stoppered with cotton and left at an ambient temperature for at least 3 days. The clarity, color and possible presence of clouds, deposits and films are examined over this time. A microscopic examination is carried out in the case of cloud, deposit or film or a color change.

4.3..2 Incubator quality tests

A 100 mL wine sample, after filtration on coarse sterilized filter paper, is placed in 300 mL sterile conical flask stopped with cotton, put in an incubator at 30°C and examined after at least 72 hours. Organoleptic or visible changes can be indicative of microbial development. A microscopic examination must therefore be made.

5. MICROSCOPIC TECHNIQUES FOR THE DETECTION AND DIFFERENTIATION OF MICRO-ORGANISMS, AND FOR THE DIRECT COUNTING OF YEASTS

5.1 Microscopic examination of liquids or deposits

Objective:

Microscopic examination under cool conditions is aimed at detecting and differentiating the yeasts from the bacteria that might be present, in terms of their size and shape. Microscopic observation cannot distinguish between viable and non-viable microorganisms.

Comment:

With appropriate staining (see below), an estimation of the viable yeasts can be made.

Principle:

This technique is based on the magnification made by a microscope that allows the observation of micro-organisms, whose size is on the order of a micron.

Operation method:

Microscopic examination can be carried out directly on the liquid or on the deposit.

Direct observation of the liquid will only be useful when the population is sufficiently high (more than 5×10^5 cells/mL).

When wine shows a lower microorganism population, it is necessary to concentrate the sample. Thus, about 10 mL of homogenized wine is centrifuged at 3000 - 5000 rpm for 5 to 15 minutes. After decanting the supernatant, the deposit is re-suspended in the liquid remaining at the bottom of the centrifugation tube.

To carry out the microscopic observation, a drop of the liquid sample or the homogenized deposit is placed on a clean glass slide with a Pasteur pipette or a sterilized wire. It is covered with a cover glass and placed on a slide on the stage of the microscope. Observation is made in a clear field, or preferably in phase contrast, which allows a better observation of detail. A magnification of x400 - x1000 is generally used.

5.2. Gram staining for the differentiation of bacteria isolated from colonies (see paragraph 6)

Objective:

Gram staining is used to differentiate between lactic bacteria (Gram positive) and acetic bacteria (Gram negative) and also to observe their morphology.

Comments:

It must be remembered that Gram staining is not sufficient to reach a conclusion, as other bacteria in addition to lactic and acetic bacteria may be present.

Principle:

This color is based on the difference in the structure and chemical composition of the cell walls between Gram positive and Gram negative bacteria. In Gram negative bacteria, the cell walls that are rich in lipids have a much reduced quantity of peptidoglycan. This allows the penetration of alcohol and the elimination of the gentian-violet-iodine complex, forming when the colorless cell is left, which will then be re-colored in red by saffron. Conversely, the cell walls of Gram positive bacteria contain a large quantity of peptidoglycan and a low concentration of lipids. Thus, the thick peptidoglycan wall and the dehydration caused by the alcohol do not allow the alcohol to eliminate the coloring of the gentian-violet-iodine complex.

Gram staining loses its usefulness if it is performed on a culture that is too old. Thus, the bacteria must be in an exponential growth phase within 24 to 48 hours. Gram staining is carried out after isolating the colonies and liquid cultivation.

Solutions:

The water used must be distilled.

1. Gentian violet solution

Preparation: Weigh 2g of gentian violet (or crystal violet), and put into a 100 mL conical flask and dissolve in 20 mL of 95% vol. alcohol. Dissolve 0.8g of ammonium oxalate in 80 mL of distilled water. Mix the two solutions together and only use after a period of 24 hours. Filter through paper at time of use. Keep out of light in a dark flask.

2. Lugol solution

Preparation: Dissolve 2g of potassium iodide in a minimal quantity of water (4 to 5 mL) and dissolve 1g of iodine in this saturated solution. Make the volume up to 300 mL with distilled water. Keep out of light in a dark flask.

3. Saffranin solution:

Preparation: Weigh 0.5g of saffranin in a 100 mL conical flask, dissolve with 10 mL of 95% vol. alcohol and add 90 mL of water. Stir. Keep out of light in a dark flask.

Operating method:

Smear preparation

Make a subculture of the bacteria in liquid or solid medium. Collect the young culture bacteria from the deposit (after centrifugation of the liquid culture) or

directly from the solid medium with a loop or wire and mix in a drop of sterilized water.

Make a smear on a slide, spreading a drop of the microbial suspension. Let the smear dry, and then carry out fixation, rapidly passing the slide 3 times through the flame of a Bunsen burner, or equivalent. After cooling, perform staining.

Staining

Pour a few drops of gentian violet solution onto the fixed smear. Leave to react for 2 minutes and wash off with water.

Pour in 1 to 2 drops of lugol solution. Leave to react for 30 seconds. Wash with water and dry with filter paper.

Pour on 95% vol. alcohol, leave for 15 seconds. Rinse with water and dry with filter paper.

Pour on a few drops of saffranin solution, leave to react for 10 seconds. Wash with water and dry with filter paper.

Place a drop of immersion oil on the smear.

With the immersion objective, observe through a microscope in clear field.

Results:

Lactic bacteria remain violet or dark blue colored (Gram positive). Acetic bacteria are red colored (Gram negative).

5.3 Catalase Test for the differentiation of bacteria isolated from colonies (see paragraph 6)

Objective:

This test is aimed at making a distinction between acetic and lactic bacteria. The yeasts and acetic bacteria have a positive reaction. Lactic bacteria give a negative response.

Comments:

It must be taken into account that the catalase test is insufficient as other bacteria in addition to lactic and acetic bacteria may be present.

Principle:

The catalase test is based on the property that aerobic micro-organisms have of decomposing hydrogen peroxide with release of oxygen:

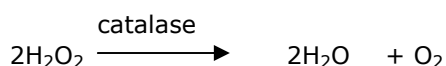

Reagent:

12 Volume hydrogen peroxide solution (3%)

Preparation: Measure 10 mL of 30% by volume hydrogen peroxide in a 100 mL calibrated flask and fill with freshly boiled distilled water. Stir and keep in the refrigerator in a dark flask. The solution must be freshly prepared.

Operating method:

Place a drop of 3% by volume hydrogen peroxide on a slide and add a small sample of young colony. If gas is released, it can be concluded that catalase activity is occurring in the culture. It is sometimes difficult to observe gas clearing immediately, particularly with bacterial colonies. It is therefore advisable to examine the culture through a microscope (objective x10).

5.4. Yeast cell count – Haemocytometry

5.4.1 Scope

Determination of yeast cell concentration in fermenting musts or wines, and ADY (Active Dry Yeast). A high cell concentration is required: at least 5×10^6 cells/ml. Fermenting musts and wines can be counted directly, ADY must be diluted 1000 or 10 000 times. Musts or wines containing fewer cells must be centrifuged (3000 g, 5 minutes) and the sediment resuspended in a known volume.

5.4.2 Principle

A drop of yeast cell suspension is placed on the surface of a slide with a counting chamber. The counting chamber has a defined volume and is subdivided in squares on the surface of the slide. Counting is made under a microscope in light field. Phase contrast is not indicated if cells are stained,

5.4.3 Reagents and materials

- Haemocytometer, double chamber, preferably with clips: Bürker, Thoma, Malassez, Neubauer.
- Haemocytometer cover slip: common (0.17 mm width) cover slips are not suitable to this use, because they are flexible and do not guarantee that the chamber width is constant.
- Pipettes, fine tips, 1 and 10 ml volume.
- Volumetric flask, 100 ml.
- Beaker, 250 ml.

5.4.4 Installations and equipment

- Microscope with bright field illumination: magnification 250-500 x. Phase contrast is contraindicated.
- Magnetic plate and stirring bar.

Haemocytometers are available with different counting chambers: Bürker, Thoma, Malassez, Neubauer. Confirm the identity and the volume of the counting chamber to be used. Bürker, Thoma and Neubauer chambers have 0.1 mm depth, Malassez chamber is 0.2 mm deep.

Thoma chamber has one central large (1 mm²) square, so its volume is 0.1 mm³ (10⁻⁴ ml). This large square is subdivided in 16 squares, themselves further divided in 16 smaller squares. These small squares each have 0.05 mm x 0.05 side and 0.1 mm depth, so that the volume of each small square is 0.00025 mm³ (25 x 10⁻⁸ ml). It is also possible to count in the medium squares, each medium square having 16 small squares 0.2 x 0.2 mm, and 0.004 mm³ area, or 4 x 10⁻⁶ ml volume.

Bürker chamber contains 9 large 1mm² squares, which are divided into 16 0.2mm sided medium squares, separated by double lines with a 0.05mm spacing. The area of the medium squares is 0.04mm² and the volume is 0.004mm³. The area of the small squares formed by the double lines have an area of 0.025mm².

Big, medium and small squares of Neubauer, Thoma and Bürker chambers have the same size. Bürker chamber medium squares do not contain other lines inside; therefore they are probably the easiest to count.

5.4.5 Examination techniques

The counting chamber and the cover slip must be clean and dry before use. It may be necessary to scrub the ruled area, as dirty chambers influence the sample volume. Clean with demineralised water, or ethanol, and dry with soft paper.

If flocculent yeast has to be counted, the suspension medium must be 0.5% sulphuric acid, in order to avoid flocculation, but this impairs the possibility of methylene blue staining and the count of viable and dead cells. Resuspension can be carried out by sonification.

Put the sample on the slide using a fine tip pipette, following one of the two following procedures.

Procedure 1

Mix well the yeast suspension. If dilutions are required, make decimal dilutions, as usual. If a methylene blue stain is performed, make it on the most diluted sample and mix 1 ml sample with 1 ml methylene blue solution.

Constantly shake the yeast suspension. Take a sample with a fine tip pipette, expel away 4-5 drops of suspension and place a small drop of yeast suspension (diluted if necessary) on each of the two ruled areas of the slide. Cover it with the cover slip within 20 seconds and press firmly with the clips. The counting area should be completely filled, but no liquid should extend to the moat.

Procedure 2

Place the rigid cover slip so that both counting chambers are equally covered. Use the clips to press the cover slip against the support areas until iridescence lines (the Newton rings) appear. When there are no clips, do not move the cover slip when filling the chamber.

Constantly shake the yeast suspension. Take a sample with a fine tip pipette, expel away 4-5 drops of suspension and allow a small drop of sample to flow between the haemocytometer and the cover slip. Do the same in the other part of the slip. The counting area should be completely filled, but no liquid should extend to the moat.

Let the prepared slide stand for three minutes for the yeast cells to settle, and place it under the microscope.

Count 10 medium squares in each ruled area, standardizing procedures must be set, in order to avoid counting twice the same square. Cells touching or resting on the top or right boundary lines are not counted, those resting on bottom or left boundary lines are counted. Budding yeast cells are counted as one cell if the bud is less than one-half the size of the mother cell, otherwise both cells are counted.

To obtain accurate cell counts, it is advisable to count 200 – 500 total yeast cells, on average. Counts from both sides of the slide should agree within 10%. If a dilution is used, the dilution factor must be used in the calculation.

5.4.6 Expression of results

If C is the average number of cells counted in one medium square with 0.2 mm sides, the population T total in the sample is :

Expressed as cells/mL $T = C \times 0.25 \times 10^6 \times \text{dilution factor}$

If C is the average number of cells counted in one small square with 0.05mm sides, the population T total in the sample is:

Expressed as cells/mL $T = C \times 4 \times 10^6 \times \text{dilution factor}$

5.4.7 References

European Brewery Convention. Analytica Microbiologica – EBC. Fachverlag Hans Carl, 2001

5.5 Yeast cell count – Methylene blue staining of yeast cells

5.5.1 Scope

This method allows a rapid estimation of the percentage of viable yeast cells, which are not stained, because dead cells are blue-stained. The method is applicable to all samples containing yeasts, except musts containing more than 100 g/l sugar. Bacteria are too small and their staining is not visible with this method.

Note: a good focus should be achieved at various depths, in order to properly see their coloring with methylene blue.

5.5.2 Principle

Methylene blue is converted into its colourless derivative by the reducing activity of viable yeast cells. Dead yeast cells will be stained blue.

Viability is calculated from the ratio between the number of viable cells and the total number of cells. The method overestimates “real” viability when viable cells are less than 80%, because it does not distinguish between “live” cells and their ability to reproduce (Viable But Not Culturable cells).

If the sugar concentration is higher than 100 g/l, most cells are light blue, therefore this method is not recommended.

If wine has low pH and is strongly buffered, the dye cannot work properly. In this case the count must be applied at least to the first decimal dilution.

5.5.3 Reagents and materials

Solution A: Methylene blue distilled water solution, 0.1 g/500 ml.

Solution B: KH_2PO_4 , distilled water solution, 13.6 g/500 ml.

Solution C: $\text{Na}_2\text{HPO}_4 \times 12 \text{H}_2\text{O}$ distilled water solution, 2.4 g/100 ml

Solution D: 498.75 ml Solution B + 1.25 ml solution C.

Solution E: Mix the 500 ml of solution D with 500 ml solution A to give final buffered methylene blue solution, with pH approximately 4.6.

5.5.4 Installations and equipment

Microscope, 250-500 x magnifications. Phase contrast is contraindicated.

Microscope slides and cover slips, or haemocytometer (Thoma, Bürker or Neubauer chamber).

Test tube and stirring rod.

Pipettes, fine tips.

5.5.5 Examination techniques

Viability determination

Dilute the suspension of yeast with methylene blue solution in a test tube until the suspension has approximately 100 yeast cells in a microscopic field. Place a small drop of well-mixed suspension on a microscope slide and cover with a cover slip. Examine microscopically using a magnification of 400 x within 10 minutes contact with the stain.

Count a total of 400 cells (T), noting the number of blue coloured (C) dead, broken, shrivelled and plasmolyzed cells. Budded yeast cells are counted as one cell if the bud is less than one half the size of the mother cell. If the bud is equal or greater than one half the size of the mother cell, both are counted. Cell stained light blue should be considered alive.

5.5.6 Expression of results

If T is the total cell number and C the blue coloured cell number, then the

percentage of viable cells is $\frac{T - C}{T} \times 100$

5.5.7 References

European Brewery Convention. Analytica Microbiologica – EBC. Fachverlag Hans Carl, 2001

6. COUNTING OF MICRO-ORGANISMS BY CULTURE

Objective:

The purpose of counting of microorganisms by culture is to evaluate the level of contamination of the sample, that is to say, to estimate the quantity of viable microorganisms. According to the culture media used and the culture conditions, four types of microorganisms can be counted, namely, yeasts, lactic bacteria, acetic bacteria and mould.

Principle:

Enumeration by culture is based on the fact that micro-organisms are able to grow in a nutrient medium and incubation conditions suitable to form colonies on the medium solidified by agar, or turbidity in a liquid medium. On an agar medium a cell produces by proliferation a cluster of cells visible to the naked eye called colony.

6.1 Detection, differentiation and enumeration of microorganisms (plate count).

6.1.1 Scope

This standard gives general guidance for the enumeration of viable yeasts, moulds and lactic or acetic bacteria in musts, concentrated musts, partially fermented musts, wines (including sparkling wines) during their manufacture and after bottling, by counting the colonies grown on a solid medium after suitable incubation. The purpose of microbiological analysis is to control the winemaking process and prevent microbial spoilage of musts or wines.

COMPENDIUM OF INTERNATIONAL METHODS OF ANALYSIS - OIV
Microbiological analysis of wines and musts

6.1.2 Terms and definitions

The terms "plate" and "Petri dish" are used as synonyms.

CFU = Colony Forming Units.

6.1.3 Method

The number of viable microorganisms present in musts or wines is determined by spreading a small known volume of sample on the surface of a culture medium or adding it as per the incorporation method (see par. 9-5 6.1.7.4), and incubating the plates for the required time in the better conditions for the growth of the microorganisms. Each cell, or cluster of cells, divides and gathers into a cluster and becomes visible as a colony. The number of colonies found on the surface of a plate states for the cells occurring in the original sample so that the results are reported as CFU. If the number of cells in a sample is supposed to be high, suitable serial decimal dilutions are performed in order to obtain colonies ranging from 15-10 to 300 per plate. If the number of CFU in a sample is supposed to be low, they are collected on the surface of a sterile 0.45 to 0.88 µm filter for yeasts of 0.22 to 0.45 µm and for bacteria, which is then placed in the Petri dish on the surface of the culture medium.

The measuring range of this method rises from < 1 CFU/(analyzed volume) to 10⁹ CFU/ml or 10¹⁰ CFU/g in the original sample.

6.1.4 Reagents and materials

As indicated in paragraph 1 of the resolution, plus:

- Tubes (16x160 mm or similar) containing 9 ml sterile peptone water (Tryptone: 1 g/l) or other diluents to be used for serial sample dilutions (Appendix 4). An indicative number of tubes required for the following samples is reported below:

Unfermented musts: 4 / sample.

Fermenting musts: 7 / sample.

Wines in storage: 2 / sample.

- Micropipette holding sterile tips: 1 ml and 0.2 ml.

- L-shaped or triangular-shaped bent glass rods (Drigalski rods) or plastic spreaders.

- 90-mm diameter Petri dishes (56 cm²) (with 15-20 ml of growth medium) for pour plate technique, and 90-mm or 60-mm diameter plates (with 6-8ml of growth medium) for membrane filter technique, filled 18-24 h in advance with 15-20 ml of culture medium (simple or double dishes are required for each sample tested):

- For yeasts counts use: YM, YEPD, WL Nutrient Agar, YM Agar or TGY Agar. If searching non-*Saccharomyces* yeasts, Lysine Agar and WL Differential Agar plates (AppendixAppendix 5, culture medium) or equivalent if validated.

- For acetic acid bacteria counts use: GYC agar, G2 or Kneifel medium (AppendixAppendix 5, culture medium) or equivalent if validated

- For lactic acid bacteria counts use: MRS plus 20% tomato (or apple- or grape-) juice, or modified ATB Agar (medium for *Oenococcus oeni*), or TJB plus agar, or Milieu Lafon-Lafourcade, milieu 104, MTB agar (AppendixAppendix 5 culture medium) or equivalent if validated

- For filamentous fungi counts use Czapek-Dox modified agar, DRBC agar or MEA added with tetracycline (100 mg/l) and streptomycin (100 mg/l). (Appendix 5 culture medium) or equivalent if validated

COMPENDIUM OF INTERNATIONAL METHODS OF ANALYSIS - OIV
Microbiological analysis of wines and musts

- Antibiotics must be added in order to make the counting selective since all the microorganisms are together in wine.(see Appendix I culture media)

6.1.5 Installations and equipment

As indicated in paragraph 2 of the resolution.

6.1.6 Sampling

As indicated in paragraph 3 of the resolution

The following amounts of samples are required for the plate counting:

Must, or fermenting must or wine in storage: not less than 250 ml;

Bottled or packed wine: not less than one unit,
whatever the capacity;

6.1.7 Examination techniques

6.1.7.1 Preliminary requisites

All the materials and equipments used in the tests must be sterile, and aseptic condition must be kept during all operations.

The laminar flow cabinet must be switched on 5 minutes before starting the work, in order to have a sterile and stable air flow.

6.1.7.2 Sterilization

Culture media must be sterilized in autoclave at 121°C for at least 15 minutes (20 minutes for large volumes). Single-use sterile materials and glassware must be opened and used under laminar flow cabinet. Tweezers and spreading devices must be immersed in ethanol and flamed before use. Stainless steel funnels must be flamed with ethanol after each use, while glass- and polycarbonate funnels must be autoclaved before use, so these ones must be available in the same number as the tested samples.

6.1.7.3 Sample dilution (Appendix 1)

One ml of sample is pipetted in a sterile 9 ml peptone water tube. The tube is stirred with the aid of a "vortex" shaker for 20 seconds. This is the first (decimal) dilution, from which 1 ml is transferred to the next 9-ml sterile peptone water tube, which is the second dilution. After 20 seconds shaking, the operation is repeated until necessary.

The indicative number of serial dilutions required for the following samples is reported below:

Unfermented musts: 4 decimal dilutions.

Fermenting musts: 7 decimal dilutions.

Unfiltered wines during ageing (Yeast counts): 2 decimal dilutions.

Unfiltered wines during ageing (Lactic Acid Bacteria counts) : 6 decimal dilutions.

Filtered wines or packed (bottled) wines dilution. No

Prepare and sterilize 15 ml of medium in tubes, and keep the tubes in a water bath (*or equivalent if validated*) at $47 \pm 1^\circ\text{C}$.

Pour 1 ml of sample or dilution in an empty Petri dish.

Add 15 ml culture medium and stir gently the Petri dish, so as to obtain a homogeneous distribution of microorganisms within the mass of the medium.

Allow to cool and solidify by placing the Petri dishes on a cool horizontal surface (the solidification time of the agar shall not exceed 10 min).

6.1.7.5 Enumeration with concentration by membrane filtration

Membrane porosity must be 0.45 or 0.8 μm for yeast counting; 0.2 or 0.45 μm for counting bacteria. Membrane surface must be preferably be cross-hatched, in order to facilitate the colony counting.

The plates, on which the membranes are put, can contain an agar nutrient medium or a pad, in which the dry medium is dispersed, that must be soaked with sterile water just before the use. Some suppliers give sterile plates containing a sterile pad, on which the content of 2-ml of single-use sterile liquid medium is poured just before the use.

Aseptically assemble the filtration equipment, sterilize the funnel according to 9.2, and connect to the vacuum-producing system.

Dip the tweezers in ethanol and flame them: when the flame is extinguished, wait some seconds and put the membrane, with the tweezers, on its holder of the filtration unit.

Before opening the bottle, shake it well; dip the bottleneck upside-down in ethanol (1-2 cm) and flame to sterilize it.

Of each sample sample three amounts: 10 ml with a sterile 10-ml pipette, 100 ml with a sterile cylindrical 100-ml pipette, and the rest direct from the bottle, if possible. To filter the wine, pour the wine into the funnel.

When the desired amount of wine has been filtered, release the vacuum, flame the tweezers, open the funnel, keep the membrane with the tweezers, put its opposite edge on the solid medium of a plate and make it adhere to the medium surface, avoiding bubble formation beneath.

6.1.7.6 Sample incubation

Incubate the plates, upside-down, aerobically 4 days at $25 \pm 2^\circ\text{C}$, for yeast or for acetic acid bacteria. If temperature is $< 23^\circ\text{C}$ extend incubation one more day, if temperature is $< 20^\circ\text{C}$ extend three more days. The maximum temperature must not exceed 28°C .

In case of performing *Brettanomyces* (or *Dekkera*) yeast counts, increase twofold the incubation time.

In case of performing LAB count, put the plates in an anaerobic jar or bag, and incubate the plates upside-down 10 days at $30 \pm 2^\circ\text{C}$. If temperature is $< 28^\circ\text{C}$ extend incubation one more day, if it is $< 25^\circ\text{C}$ extend three more days. The maximum temperature must not exceed 33°C .

6.1.8 Expression of results

6.1.8.1 Counting yeast colonies and bacteria.

Count the colonies grown in 4 days for the yeast and acetic acid bacteria (8 days for *Brettanomyces/Dekkera* yeasts), and 10 days for lactic bacteria, if necessary with the aid of a colony counter, ignoring the different colony morphology if performing a total yeast count, or considering it, if required.

The media and incubation conditions are specific enough for it to be possible to count the different types of micro-organisms in the colonies visible to the naked eye.

6.1.8.2 Calculation of results.

The most reliable results come from counting plates containing from 10 to 300 colonies (ISO 7218:2007 - Microbiology of food and animal feeding stuff - General rules for microbiological examinations).

Calculate the number N of microorganisms present in the test sample as a weighted mean from two successive dilutions using the following equation:

$$N = \frac{\sum C}{V \times 1,1 \times d}$$

where:

$\sum C$ is the sum of colonies counted on the two dishes retained from two successive dilutions, at least one of which contains a minimum of 10 colonies.

V is the volume of the inoculum placed in each dish, in millilitres.

d is the dilution corresponding to the first dilution retained [$d=1$ when the undiluted liquid product (test sample) is retained].

In other words, if plates from two consecutive decimal dilutions contain 10-300 colonies, compute the number of CFU/ml for each dilution, and then the average of the two values: this is the CFU/ml value of the sample. If one value is greater than the double of the other, keep the lower one as CFU/ml.

Round off the results to two significant figures only at the time of conversion to CFU/ml, and express the results as a number between 1,0 and 9,9 multiplied by the appropriate power of 10 (ISO 7218:2007 - Microbiology of food and animal feeding stuff - General rules for microbiological examinations).

If samples were inoculated in duplicate series, and one or two plates, inoculated with the same dilution, contain colonies, compute the average of the number of colonies and multiply by the reciprocal of the dilution factor, to obtain the number of CFU/ml.

If there is no plate containing 10-300 colonies, and all plates contain more than 300 colonies, count the less crowded ones. If they contain less than 10 colonies/cm², count 12 squares of 1 cm² and multiply the average by 56 (the area of a 90-mm diameter plate); if colonies are more crowded, count 4 squares of 1 cm² and multiply the average by 56. Express the results as "Estimated CFU/ml". Do not express the results as TNTC (Too numerous to count) whenever possible.

If the only plates containing colonies contains less than 10 colonies, but at least 4, calculate the result as given in the general case, and report it as "Estimated CFU/ml".

If the total is from 3 to 1, the precision of the result is too low, and the result shall be reported as "(the searched microorganisms) are present but less than 4 × d CFU/ml".

COMPENDIUM OF INTERNATIONAL METHODS OF ANALYSIS - OIV
Microbiological analysis of wines and musts

If plates from all dilutions of any sample have no colonies, report the results as "less than 1/d CFU/ml", but consider the possible presence of inhibitors in the sample.

When performing membrane filtration technique, express the results referring to the amount of filtered liquid, e.g. CFU/bottle, CFU/100 ml, or CFU/10ml.

6.1.9 Uncertainty of measure

6.1.9.1 Criteria of controlling the results.

For each lot of medium, one plate is used as sterility control after sterilization. One plate per each culture medium used during the tests, is left opened under laminar flow cabinet during all operations, as a sterility check of the working environment. That plate will be incubated as the inoculated ones.

Periodically, one sample is inoculated in double, and the experimental K_p is calculated with the following equation:

$$Kp = \frac{|C_1 - C_2|}{\sqrt{C_1 + C_2}}$$

where C_1 and C_2 are the results of the two counts.

If $Kp < 1.96 \approx 2,0$ the results are acceptable: the average of the two counts can be used as the result.

If $2.0 < Kp \leq 2.576 \approx 2.6$ the difference of the two counts is critical, and must be carefully evaluated before accepting the results as the average of the two counts.

If $Kp > 2.6$ the difference of the two counts is anomalous. The result is rejected and the test must be repeated. In such event the person in charge of the laboratory must examine all the results obtained after the last acceptable ones.

6.1.9.2 Uncertainty of measure

If the number of counted colonies in the countable plate is lower than 10, the result is acceptable, but the population of colonies is considered to follow the Poisson distribution. The 95% confidence level, and consequently the uncertainty of measure, of the estimated count made on a single Petri dish, is reported in the following table.

Number of colonies	Confidence limit at 95% level		Percent error of the limit *	
	Lower	Upper	Lower	Upper

COMPENDIUM OF INTERNATIONAL METHODS OF ANALYSIS - OIV
Microbiological analysis of wines and musts

1	<1	6	-97	457
2	<1	7	-88	261
3	<1	9	-79	192
4	1	10	-73	156
5	2	12	-68	133
6	2	13	-63	118
7	3	14	-60	106
8	3	16	-57	97
9	4	17	-54	90
10	5	18	-52	84
11	6	20	-50	79
12	6	21	-48	75
13	7	22	-47	71
14	8	24	-45	68
15	8	25	-44	65
* Compared to the microorganism count (1 st column)				

If the colony count is >10, the confidence limit at a *p* probability level is calculated with the following equation:

$$C = C_i \pm K_p \sqrt{C_i}$$

where C_i is the number of colonies on the plate, and K_p is the coverage factor. Usually the coverage factor is 2, or 1.96. C value is calculated from each plate and multiplied by the number of dilutions, together with the result of the count.

6.2. Culture in liquid medium- "Most Probable Number" (MPN)

6.2.1 Objective

The purpose of this technique is to evaluate the number of viable microorganisms in wines having high contents of solid particles in suspension and/or high incidence of plugging.

6.2.2 Principle

This technique is based on the estimation of the number of viable microorganisms in liquid medium, starting from the principle of its normal distribution in the sample.

6.2.3 Diluents and liquid culture media (see Appendices 4 and 5)

6.2.4 Operating method

Several quantitative and successive solutions are prepared and following this, after incubation, a certain proportion of tests will not lead to any growth (negative tests), while others will begin to grow (positive tests). If the sample and the dilutions are homogeneous, and if the number of dilutions is sufficiently high, it is possible to treat the results statistically, using suitable tables (tables based on McCrady's probability calculations), and to extrapolate this result to the initial sample.

6.2.5 Preparation of dilutions

Starting from a sample of homogenized wine, prepare a series of decimal dilutions ($1/10$) in the diluent.

COMPENDIUM OF INTERNATIONAL METHODS OF ANALYSIS - OIV
Microbiological analysis of wines and musts

Take 1 mL of wine and add to 9 mL of diluent in the first tube. Homogenize. Take 1 mL of this dilution to add to 9 mL of diluent in the second tube. Continue this dilution protocol until the last suitable dilution, according to the presumed microbial population, using sterilized pipettes for each dilution. The dilutions must be made until extinction, i.e. the absence of development in the lowest dilutions (*appendix 2*).

6.2.6 Preparation of inoculations

Inoculate 1 mL of wine and 1 mL of each of the prepared dilutions, mixed at the time, in, respectively, 3 tubes with the appropriate culture medium (*appendix 5*). Mix thoroughly.

Incubate the inoculated tubes in the incubator at 25°C for yeasts (3 days, up to 10 days), under aerobic conditions, and for lactic bacteria, under anaerobic or microaerophilic conditions (8 days, up to 10 days), making periodic observations up to the last day of incubation.

6.2.7 Results

All those tubes that show a microbial development leading to the formation of a whitish deposit, more or less evident and/or with a more or less marked disturbance are considered as positive. The results must be confirmed by observation through a microscope. Specify the incubation period.

The reading of the tubes is made by noting the number of positive or negative tubes in each combination of three tubes (in each dilution). For example, "3-1-0" signifies: 3 positive tubes in the 10^0 dilution (wine), 1 in the 10^{-1} dilution and zero in the 10^{-2} dilution.

For a number of dilutions higher than 3, only 3 of these results are significant. To select the results allowing for the determination of the "MPN", it is necessary to determine the "typical number" according to the examples in the following table:

Table:

Number of positive tubes for each dilution						Typical number
<i>Example</i>	10	10	10	10	10	3-1-0
a	3	3	3	1	0	3-2-0
a	3	3	2	0	0	3-2-1
a	3	2	1	0	0	3-0-1
a	3	0	1	0	0	3-2-3
b	3	2	2	1	0	3-2-3
b	3	2	1	1	0	3-2-2
c	2	2	2	2	0	2-2-2
d	0	1	0	0	0	0-1-0

Example a : take the greatest dilution for which all the tubes are positive and the two following ones.
 Example b : if a positive result is achieved for a dilution that is bigger than the last chosen dilution, it must be added.
 Example c : if no dilution achieves three positive tubes, take the dilutions that correspond to the last three positive tubes.
 Example d : instance of a very small number of positive tubes. Choose the typical number so that the positive dilution is in the ten's row.

Adapted from Bourgeois, C.M. and Malcoste, R. *in* : Bourgeois, C.M. et Leveau, J.Y. (1991).

Calculation of the Most Probable Number (MPN)

Taking account of the typical number obtained, the MPN is determined through Table A (*Appendix 3*) based on McCrady's probability calculations, considering the dilution made. If the dilution series is 10^0 ; 10^{-1} ; 10^{-2} the reading is direct. If the dilution series is 10^1 ; 10^0 ; 10^{-1} the reading is 0.1 times this value. If the dilution series is 10^{-1} ; 10^{-2} ; 10^{-3} ; the reading is 10 times this value.

Comment:

If there is a need to increase the sensitivity, a concentration 10^1 of wine can be used. To obtain this concentration of microorganisms in 1 mL, centrifuge 10 mL of wine and take 1 mL of deposit (after having taken 9 mL of excess liquid) and inoculate according to the previously described method.

6.2.8 Expression of Results

The microorganism content of wine must be expressed in cells per mL, in scientific notation to one decimal place. If the content is lower than 1.0 cells per mL, the result must be presented as "<1.0 cells per/mL".

(See annexes on following pages)

7. BIBLIOGRAPHY

- ISO 4833:2003. Microbiology of food and animal feeding stuffs – Horizontal medium for the enumeration of microorganisms – Colony count technique at 30°C.
- ISO 7218:2007 - Microbiology of food and animal feeding stuff - General rules for microbiological examinations.
- ISO 7667:1983. Microbiology - Standard layout for methods of microbiological examination.
- Pallman, C., J. B. Brown, T. L. Olineka, L. Cocolin, D. A. Mills and L. F. Bisson. 2001. Use of WL medium to profile native flora fermentations. *American Journal of Enology and Viticulture* 52:198-203;
- A. Cavazza, M. S. Grando, C. Zini, 1992. Rilevazione della flora microbica di mosti e vini. *Vignevini*, 9-1992 17-20.- ANDREWS, W. et MESSER, J. (1990). Microbiological Methods. in : AOAC Official Methods of Analysis, 15th edition, 1, 425-497, Association of Analytical Chemist, Washington.
- BIDAN, P. (1992). Analyses Microbiologiques du Vin. F.V. O.I.V. n° 910, Paris.
- BOURGEOIS, C.M. et LEVEAU, J.Y. (1991). Techniques d'analyse et de contrôle dans les industries agro alimentaires, 2ème édition, 3. Le Contrôle Microbiologique Lavoisier, Tec. & Doc., APRIA Ed. Paris.
- CARR, J. G. (1959). Acetic acid bacteria in ciders. *Ann. Rep. Long Ashton Res. Sta.*, 160.
- DE MAN, J. C. (1975). The probability of most probable number. *European Journal of Applied Microbiology*, 1, 67-78.
- LAFON-LAFOURCADE, S. et al. (1980). Quelques observations sur la formation d'acide acétique par les bactéries lactiques. *Conn. Vigne Vin*, 14, 3, 183-194.
- MAUGENET, J. (1962). Les Acétobacter du cidre. Identification de quelques souches. *An. Technol. Agric.*, 11, 1, 45-53.
- PLARIDIS et LAFON-LAFOURCADE, S. (1983). Contrôle microbiologique des vins. *Bull. O.I.V.*, 618, 433-437, Paris.
- RIBÉREAU-GAYON, J. et PEYNAUD, E. (2004). *Traité d'Oenologie*, Tome 2, Librairie Polytechnique CH. Béranger, Paris et Liège.
- Standard Methods for the Examination of Water and Waste Water (1976). 14th edition, American Public Health Association, Incorporated, New York.
- Standard Methods for the Examination of Water and Waste Water (1985). 16th edition, American Public Health Association, DC 20005, Washington.
- VAZ OLIVEIRA, M., BARROS, P. et LOUREIRO, V. (1995). Analyse microbiologique du vin. Technique des tubes multiples pour l'énumération de micro-organismes dans les vins - "Nombre le plus probable" (NPP), F.V. O.I.V. n° 987, Paris.
- VAZ OLIVEIRA, M. et LOUREIRO, V. (1993). L'énumération de micro-organismes dans les vins ayant un indice de colmatage élevé, *Compte rendu des*

travaux du groupe d'experts "Microbiologie du Vin" de l'O.I.V., 12ème session, annexe 2, Paris.

- VAZ OLIVEIRA, M. et LOUREIRO, V. (1993). L'énumération de micro-organismes dans les vins ayant un indice de colmatage élevé, 2ème partie, Doc. Travail du groupe d'experts "Microbiologie du Vin" de l'O.I.V., 13ème session, Paris.

Annex 1

Preparation of dilutions and inoculations

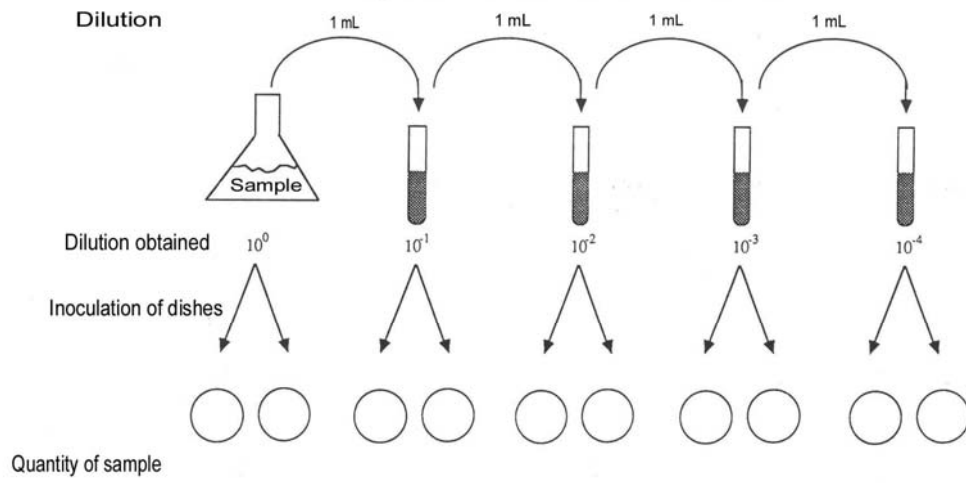

Appendix 2

Preparation of dilutions and inoculations

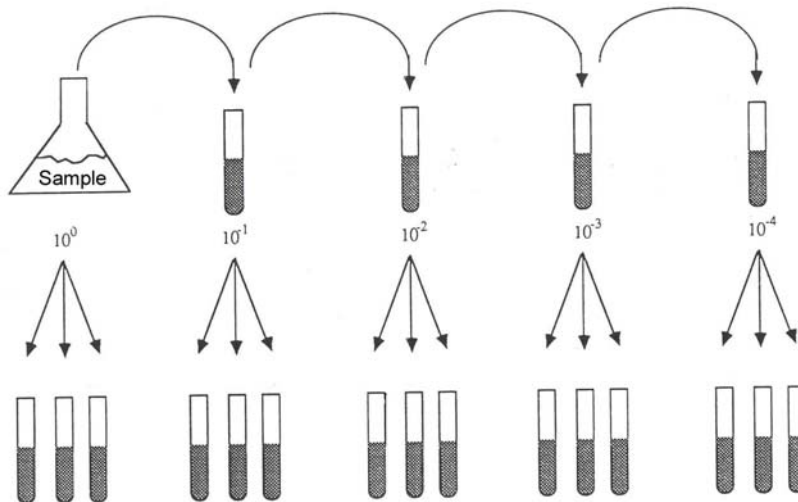

COMPENDIUM OF INTERNATIONAL METHODS OF ANALYSIS - OIV
Microbiological analysis of wines and musts

Appendix 3

TABLE A

"Most Probable Number" (MPN) for 1 mL sample utilizing 3 tubes
with 1 mL, 0.1 mL et 0.01 mL

Positive tubes				Positive tubes				Positive tubes			
1 mL	0,1 mL	0,01 mL	MPN 1 mL	1 mL	0,1 mL	0,01 mL	MPN 1 mL	1 mL	0,1 mL	0,01 mL	MPN 1 mL
0	0	0	0,0	2	0	2	2,0	1	1	1	7,5
0	0	1	0,3	2	1	0	1,5	3	1	2	11,5
0	1	0	0,3	2	1	1	2,0	3	1	3	16,0
0	1	1	0,6	2	1	2	3,0	3	2	0	9,5
0	2	0	0,6	2	2	0	2,0	3	2	1	15,0
1	0	0	0,4	2	2	1	3,0	3	2	2	20,0
1	0	1	0,7	2	2	2	3,5	3	2	3	30,0
1	0	2	1,1	2	2	3	4,0	3	3	0	25,0
1	1	0	0,7	2	3	0	3,0	3	3	1	45,0
1	1	1	1,1	2	3	1	3,5	3	3	2	110,0
1	2	0	1,1	2	3	2	4,0	3	3	3	>140,0
1	2	1	1,5	3	0	0	2,5				
1	3	0	1,6	3	0	1	4,0				
2	0	0	0,9	3	0	2	6,5				
2	0	1	1,4	3	1	0	4,5				

Adapted from the " Standard Methods for the Examination of Water and Waste Water " (1976)

Appendix 4

Diluents:

Diluents are indicated by way of example. The water to be used must be distilled, double distilled or deionized, with no traces of metals, inhibitors or other anti- microbial substances.

1. Physiological water

Preparation: Weigh 8.5g of sodium chloride in a 1000 mL calibrated flask. After it has dissolved in the water, adjust the reference volume. Mix thoroughly. Filter. Distribute 9 mL in the test tubes. Stop with carded cotton and autoclave for 20 min at 121°C.

2. Ringer's solution 1/4

Preparation: Weigh 2.250g of sodium chloride, 0.105g of potassium chloride, 0.120g of calcium chloride (CaCl₂.6H₂O) and 0,050g of sodium hydrogen carbonate in a 1000 mL calibrated flask. After it has dissolved in water, make up to the mark. Mix thoroughly. Distribute 9 mL in the test tubes. Stop with carded cotton and autoclave for 15 min at 121°C. (This solution is available commercially)

3. Peptone water

Preparation: Weigh 1g of peptone in a 1000 mL calibrated flask. After it has dissolved in the water, adjust the reference volume. Mix thoroughly. Distribute 9 mL in the test tubes. Stop with carded cotton and autoclave for 20 min at 121°C.

Appendix 5

Culture media

Culture media and antimicrobials are indicated by way of example.
The water to be used must be distilled, double distilled or deionized with no traces of metals, inhibitors or other antimicrobial substances.

1. Solid culture media

If not otherwise stated, pH of all media should be adjusted to pH 5.5 -6.0

1 MEDIA FOR YEAST COUNT

1.1 YM

Glucose	50 g
Peptone	5 g
Yeast extract	3 g
Malt extract	3 g
Agar-agar	20 g
Water: up to	1000 ml

If necessary add 100 mg chloramphenicol to suppress bacterial growth and 150 mg biphenyl to suppress mould growth.

1.2 YEPD

Glucose	20 g
Peptone	20 g
Yeast extract	10 g
Agar-agar	20 g
Water: up to	1000 ml

If necessary add 100 mg chloramphenicol to suppress bacterial growth and 150 mg biphenyl to suppress mould growth.

1.3 WL Nutrient Agar

Glucose	50 g
Peptone	5 g
Yeast extract	4 g
Potassium phosphate monobasic (KH ₂ PO ₄)	0.55 g
Potassium chloride (KCl)	0.425 g
Calcium chloride (CaCl ₂)	0.125 g
Magnesium sulphate (MgSO ₄)	0.125 g
Ferric chloride (FeCl ₃)	0.0025 g
Manganese sulphite (MnSO ₄)	0.0025 g
Bromcresol green	0.022 g
Agar bacteriological	12 g
Water: up to	1000 ml
pH	5.5

WL Differential agar is made by adding 4 mg/l cycloheximide to WL Nutrient Agar.

COMPENDIUM OF INTERNATIONAL METHODS OF ANALYSIS - OIV
Microbiological analysis of wines and musts

If necessary add 100 mg chloramphenicol to suppress bacterial growth.

1.4 Lysine Agar ASBC

Solution A:

Yeast Carbon Base	2.35 g
Water: up to	100 ml

Sterilize by membrane filtration.

Solution B:

Lysine-HCl	0.5 g
Agar agar	4 g
Water: up to	100 ml

Sterilize in 20 min. at 121 °C.

If necessary add 100 mg chloramphenicol to suppress bacterial growth.

2 MEDIA FOR LACTIC ACID BACTERIA COUNT

2.1 M.R.S. + tomato (or apple) juice.

Glucose	20 g
Peptone	10 g
Beef extract	8 g
Yeast extract	4 g
Potassium phosphate, dibasic (KH ₂ PO ₄)	2 g
Sodium acetate · 3H ₂ O	5 g
Ammonium citrate	2 g
Magnesium sulphate · 6H ₂ O	0.2 g
Manganese sulphate · 4H ₂ O	0.05 g
"Tween 80"	1 ml
Agar agar	12 g
Tomato (or apple, or grape) juice	200 ml
Water up to	1000 ml

Add 100mg / L natamycin (pimaricin) to inhibit the growth of yeasts, after autoclaving, just before use.

2.2 Tomato Juice Agar

Tomato juice (dry extract from 400 ml)	20 g
Peptone	10 g
Peptonized milk	10 g
Agar-agar	14 g
Water	1000 ml
pH	6.1

Add 100mg / L natamycin (pimaricin) to inhibit the growth of yeasts, after autoclaving, just before use.

2.3 Modified ATB medium, or *Oenococcus oeni* medium (formerly *Leuconostoc oenos* medium).

Solution A:

Glucose	10 g
---------	------

COMPENDIUM OF INTERNATIONAL METHODS OF ANALYSIS - OIV
Microbiological analysis of wines and musts

Yeast extract	5 g	
Peptone	10 g	
Magnesium sulphate	0.2 g	
Manganese sulphate	0.050 g	
Tomato juice (or apple juice or grape juice)		250 ml
Agar agar	12 g	
Water	750 ml	

Sterilize by autoclaving 20 min. at 121°C.

Solution B:

Cysteine HCl	1 g
Water: up to	100 ml
pH	4.8

Sterilize by membrane filtration.

Add 100mg / L natamycin (pimaricin) to inhibit the growth of yeasts, just before use.

Add 1 ml of solution B to 20 ml of solution A at the moment of use

2.4 Lafon-Lafourcade medium

Glucose	20 g	
Yeast extract	5 g	
Beef extract	10 g	
Peptone	10 g	
Sodium acetate	5 g	
Tri-ammonium citrate	2 g	
Magnesium sulphate · 6H ₂ O	0.2 g	
Manganese sulphate · 4H ₂ O	0.05 g	
"Tween 80"	1 ml	
Agar-agar	20 g	
Water: up to	1000 ml	
pH	5.4	

Add 100mg / L natamycin (pimaricin) to inhibit the growth of yeasts, after autoclaving, just before use.

2.5 Dubois medium (Medium 104)

Tomato juice	250 ml	
Yeast extract	5 g	
Peptone	5 g	
Malic acid	3 g	
Magnesium sulphate · 6H ₂ O	0.05 g	
Manganese sulphate · 4H ₂ O	0.05 g	
Agar-agar	20 g	
Water: up to	1000 ml	
pH	4.8	

Add 100mg / L natamycin (pimaricin) to inhibit the growth of yeasts, after autoclaving, just before use.

COMPENDIUM OF INTERNATIONAL METHODS OF ANALYSIS - OIV
Microbiological analysis of wines and musts

2.6 MTb.

Glucose	15 g
Lab-Lemco Powder (Oxoid)	8 g
Hydrolyzed casein	1 g
Yeast extract	5 g
Tomato juice	20 ml
Sodium acetate	3 g
Ammonium citrate	2 g
Malic acid	6 g
Magnesium sulphate	0.2 g
Manganese sulphate	0.035 g
"Tween 80"	1 mg
TC Vitamins Minimal Eagle, 100x (BD-Difco)	10 ml*
pH (con KOH)	5.0
Water up to	1000 ml

* add after sterilization.

Add 100mg / L natamycin (pimaricin) to inhibit the growth of yeasts, after autoclaving, just before use.

3 MEDIA FOR ACETIC ACID BACTERIA COUNT

3.1 GYC

Glucose	50 g
Yeast extract	10 g
Calcium carbonate (CaCO ₃)	30 g

Agar 25 g
Water: up to 1000 ml

Add 100mg / L natamycin (pimaricin) to inhibit the growth of yeasts, and 12.5 mg/L of penicillin to eradicate the growth of lactic acid bacteria, after autoclaving, just before use.

3.2 Medium G2

Yeast extract	1.2 g
Ammonium phosphate	2 g
Apple juice	500 ml
Agar	20 g
Water: up to	1000 ml
pH	5.0

Add 100mg / L natamycin (pimaricin) to inhibit the growth of yeasts, and 12.5 mg/L of penicillin to eradicate the growth of lactic acid bacteria after autoclaving, just before use.

3.3 Kneifel medium

Yeast extract	30 g
Ethanol	20 ml*
Agar	20 g
Bromocresol green 2.2%	1mL

COMPENDIUM OF INTERNATIONAL METHODS OF ANALYSIS - OIV
Microbiological analysis of wines and musts

Water: up to 1000 ml

* to be added after sterilization.

Add 100mg / L natamycin (pimaricin) to inhibit the growth of yeasts, and 12.5 mg/L of penicillin to eradicate the growth of lactic acid bacteria after autoclaving, just before use.

Blue colonies: *Acetobacter*, *Gluconacetobacter*

Green colonies: *Gluconobacter*

4 MEDIA FOR MOULD COUNT

4.1 Czapek-Dox, Modified

Sucrose 30 g

NaNO₃ 3 g

K₂HPO₄ 1 g

MgSO₄ 0.5 g

KCl 0.5 g

FeSO₄ 0.01g

Agar 15 g

Final pH (at 25°C) 7.3 ± 0.2

Add 10 mg/l cycloheximide to suppress yeast growth (cycloheximide-resistant yeast growth is usually slower than mould growth).

Note: This medium allows the growth only of nitrate-growing moulds.

Add tetracycline (100 mg/l) and streptomycin (100 mg/l) to suppress growth of bacteria.

4.2 Dichloran Rose Bengal Chloramphenicol Agar (DRBC Agar)

Glucose 10 g

Peptone 5 g

KH₂PO₄ 1 g

MgSO₄ 0.5 g

Rose Bengal 0.025 g

Dichloran (2,6 dichloro-4-nitroaniline) 0.002g

Chloramphenicol solution (0.1 g/10ml)* 10 ml

Agar 15 g

Final pH (at 25°C) 5.6 ± 0.2

* To be added after sterilization.

4.3 Malt Extract Agar (MEA)

Glucose 20 g

Malt extract 20 g

Peptone 5 g

Agar 15 g

Final pH (at 25°C) 5.5 ± 0.2

Add tetracycline (100 mg/l) and streptomycin (100 mg/l) to suppress growth of bacteria.

2. Liquid culture media

2.1. For yeasts

YEPD medium (Yeast Extract, Peptone, Dextrose) + chloramphenicol

Preparation: Weigh 10.0g of yeast extract (Difco or equivalent), 20g of peptone, 20g of glucose and 100 mg of chloramphenicol. Dissolve, make up to 1000 mL volume with water and mix.

Distribute 5 mL portions of this medium in the test tubes and autoclave for 15 minutes at 121°C.

2.2. For lactic bacteria

MTJ medium (50% MRS medium "Lactobacilli Man Rogosa and Sharpe Broth" + 50% TJB medium "Tomato Juice Broth") + actidione

Preparation: Weigh 27.5g of MRS "Lactobacilli Man Rogosa and Sharpe Broth" (Difco or equivalent). Add 500 mL of water, heat to boiling to permit complete dissolution and add 20.5g of TJB "Tomato Juice Broth" (Difco or equivalent). Add 50g of actidione. Dissolve with water in order to obtain 1000 mL of solution having first corrected the pH to 5 with 1N hydrochloric acid and mix.

Distribute 10 mL portions of this medium³⁾ in the tubes and autoclave for 15 minutes at 121°C.

3) The 10 mL volume is used instead of the 5 mL volume as with yeasts, due to the greater sensitivity of lactic bacteria to oxygen.

APPENDIX 6: RECOGNITION OF SPECIFIC MICROORGANISMS

6.1 Yeast colony recognition on WL Nutrient Agar.

The use of this medium does not want to be a method to identify species, but can offer to non-specialized laboratories a quick and cheap way to predict the genus of viable and culturable yeasts. After 4-days incubation evaluate the colony morphology as follows (Pallman, C., J. B. Brown, T. L. Olineka, L. Cocolin, D. A. Mills and L. F. Bisson. 2001. Use of WL medium to profile native flora fermentations. American Journal of Enology and Viticulture 52:198-203; A. Cavazza, M. S. Grando, C. Zini, 1992. Rilevazione della flora microbica di mosti e vini. *Vignevini*, **9**-1992 17-20):

- ***Saccharomyces*** spp.: Colonies grow well in 4 days on WL Nutrient Agar giving circular cream-coloured to pale greenish colonies. Different colour shades do not necessary indicate the presence of different strains, but the presence of petite mutants; colonies are umbonated, smooth and dull surface, the consistency is butyrous. It doesn't grow on Lysine Agar.

- ***Torulaspora*** spp.: the colonies are similar to those of *Saccharomyces* spp. It grows on Lysine Agar.

- ***Hanseniaspora*** spp. (***Kloeckera*** spp.) Grows on WL Nutrient Agar in 4 days, giving deep green flat, smooth and butyrous colonies. It grows on Lysine Agar and on WL Differential Agar.

- ***Candida stellata*** Grows on WL Nutrient Agar in 4 days, giving pea-green, smooth and butyrous colonies, becoming darker in the centre with the age. It grows on Lysine Agar.

- ***Saccharomyces*** spp. Grows on WL Nutrient Agar in 4 days, giving light green, smooth and butyrous convex colonies. It grows on Lysine Agar, not on WL differential agar.

Note: its cells, viewed under the microscope, are very large (up to 25 µm).

- ***Schizosaccharomyces pombe*** Grows on WL Nutrient Agar in 4 days, giving deep green pinpoint size, smooth colonies. It grows on Lysine Agar.

Note: its cells, under the microscope are easily recognised because of typical scission division.

- ***Rhodotorula*** spp. Grows on WL Nutrient Agar in 4 days, giving deep pink, smooth and mucous surface and butyrous colonies. It grows on Lysine Agar.

- ***Metschnikowia*** spp. Grows on WL Nutrient Agar in 4 days, giving clear, smooth and butyrous little colonies. A reddish pigment diffuses in the medium below the colonies. It grows on Lysine Agar.

- ***Pichia membranifaciens*** Grows on WL Nutrient Agar in 4 days, giving greyish- or bluish-shaded rough and powdery convex colonies. It grows on Lysine Agar.

- ***Pichia anomala*** (formerly *Hansenula anomala*) grows on WL Nutrient Agar in 4 days, giving cream-colored or bluish colonies, distinctly bluish after 8 days. Colonies are circular, the surface is smooth and the consistency is butyrous, but sometimes clearly mucous. It grows on Lysine Agar.

- ***Dekkera*** spp. or ***Brettanomyces*** spp. Grows on WL Nutrient Agar in 8 days, giving small dome-shaped, cream-coloured, smooth and butyrous colonies. It produces high amounts of acetic acid, clearly perceivable by smell

that turns the medium to yellow. It grows on Lysine Agar and on WL Differential Agar. The growth on this last medium makes it possible to distinguish it from *Zygosaccharomyces bailii*.

Note: a confirmation is possible with microscopical examination: Dekkera has small cells, some of them have a typical ogival shape.

- **Zygosaccharomyces bailii** Grows on WL Nutrient Agar in 4 days, giving small circular cream-coloured, smooth and butyrous colonies. It grows on Lysine Agar but not on WL Differential Agar. A yellowish halo is often present around young colonies.

Note: when grown on bottled wine it produces brown 0,5-1 mm clusters. Its cells do not have ogival shape.

- **Acetic acid bacteria** grow on WL Nutrient Agar with small to pinpoint-size deeply green and brilliant colonies that are strongly positive to catalase test. (*Note – This medium is not suitable for their count*).

- **Lactic Acid Bacteria** grow on WL Nutrient Agar in 10 days with pinpoint size clear catalase-negative colonies. (*Note – This medium is not suitable for their count*).

6.2 Lactic Acid Bacteria colony recognition.

LAB colonies are translucent and range in size from a pinpoint to a few mm in diameter. They are gram-positive and catalase-negative. *Oenococcus oeni* grow in short chains, pediococci form tetrads and diplococci, lactobacilli form long or short bacilli.

6.3 Acetic Acid Bacteria colony recognition.

AAB colonies are catalase positive and gram-negative, and are strong acid-producers: this can be seen by a clear zone around their colonies in media containing calcium carbonate or by a different colour if the medium contains a pH indicator. Their cells are cocci or bacilli, generally a little larger than LAB.

Detection of preservatives and fermentation inhibitors

Method A 35 modified by resolution Oeno 6/2006

1. Fermentability Test

1.1 Objective

To show without specifying their nature, the possible presence of one or several substances which act as fermentation inhibitors in wine.

1.2 Principle

The wine, whose free sulfur dioxide has been bound by addition of an aqueous solution of acetaldehyde, is brought to 10% (v/v) alcohol. Glucose is added in order for the sugar concentration to be between 20 and 50 g/L in the nutrient solutions.

After inoculation with a yeast strain resistant to alcohol, the fermentation is followed by weighing the quantity of carbon dioxide released.

The fermentation rate is compared to that of an authentic natural wine similar in make up to the wine analyzed, and also to that of the test wine whose pH has been adjusted to 6 (the majority of the mineral and organic acids are not active in fermentation at this pH). These two reference wines are inoculated in the same manner as the test wine.

1.3 Apparatus

90 mL flask sealed with a rubber stopper with a hole into which is placed a narrow tube tapered at the uppermost portion.

1.4 Reagents and media

1.4.1 Aqueous acetaldehyde solution:

Solution prepared from acetaldehyde obtained by distillation of metaldehyde or paraldehyde, in the presence of sulfuric acid, and standardized by the method using sodium sulfite. Adjust the concentration of the solution to 6.9 g/L.

1 mL of this solution fixes 10 mg of sulfur dioxide.

1.4.2 Nutrient Solutions:

- Ammonium Sulfate, (NH₄)₂ SO₄ 25 g/L
- Asparagine 20 g/L

These solutions must be stored in the refrigerator.

1.4.3 Culture Medium:

- Solid medium: malt agar.

Powdered malt	3 g
Glucose	10 g
Pancreatic peptone	5 g
Powdered yeast extract	3 g
Agar	20 g
Water	1 L
pH	6

Sterilize for 20 min. at 118 °C.

This mixture exists in a commercial prepared form.

- Liquid medium (an option):

- Divide the grape juice containing 170 to 200 g/L of sugar, in tubes stoppered with cotton, at a rate of 10 mL per tube; sterilize in a water bath at 100 °C for 15 min.
- Liquid malt: same medium as the solid medium, but without agar.

1.4.4 Culture and maintenance of the *Saccharomyces bayanus* strain and preparation of the yeast.

a) Culture and maintenance of the strain on solid medium: From a collection strain, inoculate in lines (streak) onto tubes of solid medium. These tubes are put in an incubator at 25°C until the culture is very visible (about 3 days); the tubes can be stored in the refrigerator. This is sufficient for 6 months.

b) Preparation of the yeast:

One of the tubes of the liquid medium is inoculated in accordance with proper microbiological techniques from the strain cultivated on solid medium; after growth (24 to 48 h), repeat 2 times successively into the same medium enriched with 10% alcohol (v/v), to acclimate the strain.

The second culture when actively fermenting will contain about 50 million yeast per milliliter. This culture will serve to inoculate the wine to be studied. Perform a count and inoculate at a rate of 10⁵ yeast/mL.

1.5 Procedure

- Preparation of the wine:

100 mL of wine is treated with the necessary quantity of acetaldehyde calculated in accordance with the amount of free sulfur dioxide (44 mg of aldehyde binds 64 mg of sulfur dioxide). Wait 24 hours and check that the wine contains less 20 mg free sulfur dioxide per liter.

If the alcoholic strength is greater than 10% (v/v), the wine should be diluted with one of the solutions of glucose and water in amounts calculated to result

in a sugar concentration between 20 and 50 g/L, and to reduce the strength to about 10% (v/v). For wines containing less than 10% vol., add solid glucose to bring without dilution the amount of sugar between these values, so the fermentation rate is not altered by the amount of sugar.

- Fermentability test:

In a 90 mL flask, place 60 mL of wine prepared as above, 2.4 mL of ammonium sulfate solution and 2.4 mL of asparagine solution. Inoculate with 3 drops of a 3 day old culture of *Saccharomyces bayanus*, to obtain an initial population close to 10^5 yeast/mL. Install the stopper with the pointed tube, weigh the assembly to the nearest 10 mg and place in an oven at 25°C.

Weigh daily for at least 8 days.

Run each time concurrently, a wine of comparable make up and origin which does not contain any preservative along with the test wine which has been adjusted to pH 6.

A flask of non-inoculated wine indicates loss by evaporation.

1.6 Interpretation

In most cases, the fermentation begins within 48 hours and the daily liberation of gas is greatest between the 3rd and the 5th day.

One can confirm the presence of a fermentation inhibitor only in the following conditions:

- a) If the fermentation does not begin or is delayed at least 2 days compared to one of the 2 controls. When the delay is brief, it is difficult to ascertain the presence because there may be "false positive" results, since certain natural sweet wines sometimes behave as if they contained traces of inhibitors (in particular sweet wines made from grapes having noble rot).
- b) If the maximum daily release has not taken place between the 3rd and 5th day, but after the 7th day, this release must be greater than or equal to 50 mg for 60 mL of wine.
- c) Plotting the fermentation curve and the curve of daily release of CO₂ as a function of time can facilitate the interpretation in a difficult case.

Detection of preservatives and fermentation inhibitors

Method A 35 modified by resolution Oeno 6/2006

1. Detection of the following acids: sorbic, benzoic, *p*-chlorobenzoic, salicylic, *p*-hydroxybenzoic and its esters

1.1 *Thin layer chromatography*

1.1.1 Principle

The preservatives are extracted with ether from the previously acidified wine. After separation by thin layer chromatography with polyamide powder, they are located and characterized by examining the chromatogram under ultraviolet light.

1.1.2 Apparatus

- Chromatography bath.
- 20 x 20 cm glass plates.

Preparation of the plates - Mix thoroughly 12 g of dry polyamide powder with 0.3 g fluorescent indicator; add, while stirring, 60 mL of methanol; spread on plates to a thickness of 0.3 mm. Dry at normal temperature.

Note: Commercially prepared plates can be used.

1.1.3 Reagents

- Diethyl ether
- Methanol
- Ethanol, 96% (v/v).
- Sulfuric acid diluted to 20% (v/v)
- Anhydrous sodium sulfate
- Polyamide powder for chromatography (e.g., Macherey-Nagel or Merck).
- Fluorescent indicator (F₂₅₄ Merck or equivalent).
- Solvent:
 - n*-Pentane 10 vol.
 - n*-Hexane 10 vol.
 - Glacial acetic acid 3 vol.
- Standard solutions:
 - Prepare standard solutions containing 0.1 g/100 mL of 96% ethanol (v/v) of the following acids: sorbic, *p*-chlorobenzoic, salicylic, *p*-hydroxybenzoic and its esters.

- Prepare a solution of 0.2 g benzoic acid per 100 mL of 96% ethanol (v/v).

1.1.4 Procedure

Place 50 mL of wine in a separatory funnel; acidify with dilute 20% sulfuric acid (1.1.3.4), and extract 3 times using 20 mL diethyl ether (1.1.3.1) per extraction. Combine the washed solutions in a separatory funnel and wash with a few milliliters of distilled water. Dry the ether with the anhydrous sodium sulfate (1.1.3.2). Evaporate the ether dry using a 100°C water bath, or a rotary evaporator. If the evaporation is accomplished on a water bath, it is advisable to hasten the evaporation using a mild current of air until 2 or 3 milliliters remain, then finish the evaporation cold.

Dissolve the residue in 1 mL ethanol, deposit 3 to 5 µL of this solution on the polyamide plate, as well as 3 to 5 µL of the various preservative standard alcoholic solutions (1.1.3.9). Place the plate in a chromatography tank, and saturate with solvent vapors. Let the solvent migrate to a height of about 15 cm, which takes from 1.5 to 2.5 hours.

Remove the plate from the tank and allow to dry at normal temperature. Examine in ultraviolet light, at a wavelength of 254 nm. The preservatives appear from the bottom of the plate upward in the following order: *p*-hydroxybenzoic acid, esters of *p*-hydroxybenzoic, salicylic acid, *p*-chlorobenzoic acid, benzoic acid, sorbic acid.

With the exception of salicylic acid, which has a light blue fluorescence, other preservatives give dark spots on a fluorescent yellow-green background.

Sensitivity - This technique allows determination of the following minimum quantities of the miscellaneous preservatives expressed in milligrams per liter:

Salicylic acid	3
Sorbic acid	5
Esters of <i>p</i> -hydroxybenzoic acid	5
<i>p</i> -Hydroxybenzoic acid	5-10
<i>p</i> -Chlorobenzoic acid	5-10
Benzoic acid	20

1.2 High performance liquid chromatography

1.2.1 Procedure

The method is performed directly on the wine, without sample preparation. It is necessary to dilute red wines before injecting them in order to preserve the column.

Using this method, the detection threshold of preservatives in the solution analyzed is about 1 mg/L.

1.2.2 Operating conditions

Conditions which are appropriate are the following:

A. For the determination of sorbic and benzoic acid

Proceed according to the sorbic, benzoic, salicylic acid assay method in wines by high performance liquid chromatography (AS313-20-SOBESA) provided in the Compendium

B. For the determination of *p*-chlorobenzoic acid, *p*-hydroxybenzoic acid and its esters

Column: see A

Mobile phase:

Solution of ammonium acetate, 0.01 M + methanol (60 : 40)

pH: 4.5 - 4.6

Flow rate: see A

Injected volume: see A

Detector: UV, 254 nm

Temperature: see A

BIBLIOGRAPHY

JUNGE Ch., *Zeits. Unters. Lebensmit.*, 1967, **133**, 319

Method OIV-MA-AS4-02C

Type IV method

Detection of preservatives and fermentation inhibitors

Method A 35 modified by resolution Oeno 6/2006

1 Detection of the monohalogen derivatives of acetic acid

1.1 Principle

The monohalogen derivatives of acetic acid are extracted with ether from acidified wine. The ether is then extracted using a 0.5 M sodium hydroxide solution. The extraction solution must have the alkalinity maintained between 0.4 and 0.6 M. After the addition of thiosalicylic acid, the synthesis of the thioindigo is implemented by the following steps:

- a) Condensation of the monohalogen derivative with thiosalicylic acid and formation of *ortho*-carboxylic phenylthioglycolic acid;
- b) Cyclization of the acid formed in a heated alkaline medium, with the formation of thioindoxyl;
- c) Oxidation of the thioindoxyl with potassium ferricyanide in an alkaline medium with formation of thioindigo, soluble in chloroform, in which it gives a red color.

1.2 Apparatus

- Water bath at 100°C.
- Mechanical stirrer.
- Oven with a temperature of $200 \pm 2^\circ\text{C}$.

1.3 Reagents

- Diethyl ether.
- Hydrochloric acid solution diluted to 1/3 (v/v). Mix one part pure hydrochloric acid, $\rho_{20} = 1.19 \text{ g/mL}$, with 2 parts of distilled water.
- Anhydrous sodium sulfate.
- Thiosalicylic acid solution: thiosalicylic acid 3 g in 100 mL sodium hydroxide solution, 1.5 M.
- Sodium hydroxide solution, 0.5 M
- Potassium ferricyanide solution containing 2 g of $\text{K}_3\text{Fe}(\text{CN})_6$ per 100 mL of water.
- Chloroform.

1.4 *Procedure*

Place 100 mL of test wine in an extraction flask with a ground glass stopper; add 2 mL hydrochloric acid (1.3.2) and 100 mL diethyl ether (1.3.1). Shake the contents vigorously for a few seconds by hand, then for 1 h with a mechanical stirrer (1.2.2). Transfer to a separating funnel, allow to separate and recover the ether layer.

Shake the ether extract with 8 to 10 g of anhydrous sodium sulfate (1.3.3) for a few seconds.

Transfer the extract to the separating funnel, add 10 mL sodium hydroxide solution, 0.5 M (1.3.5); shake for 1 min. Allow to settle.

Remove 0.5 mL of the alkaline extract and check, by titration with sulfuric acid, 0.05 M, so that the strength falls between 0.4 and 0.6 M. Transfer the alkaline extract contained in the separating funnel into a test tube containing 1 mL of thioisalicylic acid solution. Adjust, if necessary the strength of the alkaline extract in order to bring it to the limits indicated, using a stronger sodium hydroxide solution of known strength. Shake the contents of the test tube for 30 seconds and transfer to an evaporating dish.

Place the dish on a water bath at 100°C blowing its surface with a current of cold air. Maintain the dish on the water bath at 100°C for exactly 1 hour; the residue may become practically dry in a shorter amount of time. If a crust forms on the surface of the residue during the evaporation, it is advisable to break or grind it up with a thin glass rod to facilitate the evaporation.

Place the dish in an oven maintained at $200 \pm 2^\circ\text{C}$ for exactly 30 minutes. After cooling, recover the contents of the dish with 4 mL of water; transfer into a separation funnel, add to the dish 3 mL of potassium ferricyanide solution to fully dissolve any remaining residue and add to the separating funnel. Shake for 30 seconds to facilitate oxidation. Add 5 mL chloroform, mix using 3 to 4 inversions. Allow to separate.

A pink or red color (according to the quantity of thioindigo formed) indicates the presence of monohalogen derivatives of acetic acid.

Sensitivity - The method allows detection of 1.5 to 2 mg monochloroacetic acid per liter of wine and corresponding quantities of the other derived monohalogens. Since the yield of miscellaneous extractions is not quantitative, this method cannot be used for determining the amount of these monohalogen derivatives in the wines.

BIBLIOGRAPHY

- FRIEDLANDER, *Ber. Deutsch. Chem. Gesell.*, 1906, **39**, 1062.
RAMSEY L.L., PATTERSON W.I., *J. Ass. Off. Agr. Chem.*, 1951, **34**, 827.
PERONNET M., ROCQUES S., *Ann. Fals. Fraudes*, 1953, 21-23.
Traité de chimie organique, edited by V. Grignard, 1942, **19**, 565-566.
Official Methods of Analysis of the Association of Official Analytical Chemists,
11th édition, publiée par l'Association of Official Analytical Chemists,
Washington, 1970, 340-341.
TERCERO C., *F.V., O.I.V.*, 1967, n° 224.

Method OIV-MA-AS4-02D

Type IV method

Detection of preservatives and fermentation inhibitors

Method A 35 modified by resolution Oeno 6/2006

1. Examination and determination of ethyl pyrocarbonate (diethyl dicarbonate)

1.1 Principle

The diethyl carbonate formed by degradation of ethyl pyrocarbonate (diethyl ester of pyrocarbonic acid) in the presence of ethanol is extracted from wine using carbon disulfide and the quantity determined by gas chromatography. Either of the procedures described below may be used.

1.2 Apparatus

1.2.1 Gas chromatography with flame ionization detector.

1.2.2 Columns:

- Capillary column coated with Carbowax 1540

Column length: 15.24 m

Inside diameter: 0.51 mm

- Polypropyleneglycol on Celite 545 (15:100), 60-100 mesh

Column length: 2 m

Interior diameter: 3 mm

1.3 Reagents

1.3.1 Anhydrous sodium sulfate

1.3.2 Carbon disulfide

The carbon disulfide must contain no impurities in the critical retention zone (5 to 7 min.) for maximum sensitivity in accordance with the conditions of gas chromatography as indicated in paragraph 1.4.2.

1.4 Procedure

1.4.1 Use of the capillary column.

Place 100 mL wine in a 250 mL separating funnel with 1 mL of carbon disulfide (1.3.2). Mix vigorously for 1 min. The carbon disulfide phase separated is rapidly centrifuged, then dried with anhydrous sodium sulfate (1.3.1).

Inject 10 µl of the clear liquid supernatant into the chromatograph.

Chromatography conditions:

– Detector gases:

- hydrogen: 37 mL/min.
- air: 250 mL/min.
- Gas flow:
 - nitrogen: 40 mL/min.
 - A 1/10 splitter sends to the detector the gas mixture with a flow rate of 3 to 5 mL/min.
- Temperature:
 - injector: 150 °C; oven: 80 °C; detector: 150 °C
- Detection limits:
 - 0.05 mg/L of wine

1.4.2 Use of the column for polypropyleneglycol.

Add 20 mL of wine and 1 mL of carbon disulfide (1.3.2) into a conical centrifuge tube with a stopper. Agitate vigorously for 5 minutes, then centrifuge for 5 minutes applying a centrifugal force of 1000 to 1200 g. The liquid supernatant produced is aspirated by a thin-tipped pipette; the carbon disulfide phase is dried with a small quantity of anhydrous sodium sulfate, added while stirring with a glass rod. Inject 1 µL of the clear liquid into the gas chromatograph.

Chromatography conditions.

- Detector gas:
 - hydrogen: 35 mL/min.
 - air: 275 mL/min.
- Carrier gas flow:
 - nitrogen: 25 mL/min.
- Temperature:
 - injector: 240 °C
 - oven: 100 °C
 - detector: 240 °C
- Sensitivity range:
 - 12 x 10⁻¹¹ A to 3 x 10⁻¹¹ A
- Chart speed:
 - 1 cm/min.
- Detection limit:
 - 0.10 - 0.05 mg/L of wine

Under these exact conditions, diethyl carbonate displays a retention time of about 6 min.

The calibration of the apparatus is carried out using solutions of 0.01 and 0.05% (m/v) diethyl carbonate in carbon disulfide (1.3.2).

1.5 Calculation

Quantitative determination of diethyl carbonate is carried out preferably using the internal standard method, referring to the peaks of the *iso*-butyl alcohol or *iso*-amyl alcohol which are close to that of diethyl carbonate.

Prepare two samples of test wine: one of wine with 10 mL 10% ethanol (v/v) added, the other the same wine to which has been added 1 mg diethyl carbonate per liter using 10 mL of a 100 mg/L solution of diethyl carbonate in 10% ethanol (v/v).

Treat these two samples according to one or the other of the techniques above according to the column used.

Let:

S = the peak area of the diethyl carbonate in the spiked wine

S_x = the peak area of the diethyl carbonate in the wine,

i = the peak area of internal standard in the wine,

I = the peak area of internal standard in the spiked wine .

The concentration of diethyl carbonate in mg/L of wine is:

$$\frac{S_x}{S \times \frac{i}{I} - S_x}$$

In the case where standardization is carried out using a pure standard solution of diethyl carbonate, it is necessary to predetermine the yield of the extraction with carbon disulfide in accordance with the procedure utilized. This yield is expressed by the extraction factor F, with a decimal number less than or equal to 1 (yield 100%).

Let:

S_x = the peak area of diethyl carbonate given by the wine,

S_e = the peak area given by the injection of the same volume of a standard solution of diethyl carbonate of concentration C in mg/L,

V_x = the volume of wine used in the extraction with carbon disulfide,

V_s = the volume of carbon disulfide used for the extraction,

E_e = the sensitivity for the recording of S_x,

The concentration of diethyl carbonate in mg/L of wine is:

$$\frac{C \times S_x \times E_e \times V_s}{S_e \times E_e \times F \times V_x}$$

COMPENDIUM OF INTERNATIONAL METHODS OF ANALYSIS-OIV
Detection of preservatives and fermentation inhibitors

If the concentration of the two solutions injected in the chromatograph is similar, the response is the same for the recording of S_X and of S_e ; the formula is simplified and becomes:

$$\frac{C \times S_\lambda \times V_s}{S_e \times F \times V_\lambda}$$

BIBLIOGRAPHY

- KIELHOFER E., WURDIG G., *Dtsch. Lebensmit. Rdsch.*, 1963, **59**, 197-200 & 224-228.
PRILLINGER F., *Weinberg u. Keller*, 1967, **14**, 5-15.
REINHARD C., *Dtsch. Lebensmit. Rdsch.*, 1967, **5**, 151-153.
BANDION F., *Mitt. Klosterneuburg, Rebe u. Wein*, 1969, **19**, 37-39.

Detection of preservatives and fermentation inhibitors

Method A 35 modified by resolution Oeno 6/2006

1. Examination of dehydroacetic acid

1.1 Principle

Wine acidified with sulfuric acid is extracted with a mixture of equal parts of diethyl ether and petroleum ether. After evaporation of the solvent, the extract, recovered with a small quantity of 96% ethanol (v/v) is deposited on a thin layer of polyamide and silica gel with fluorescent indicator and subjected to the action of the mobile solvent (benzene-acetone-acetic acid). The dehydroacetic acid is identified and characterized by ultraviolet examination of the chromatogram.

1.2 Apparatus

- 1.2.1 Equipment for thin layer chromatography
- 1.2.2 Oven
- 1.2.3 Rotary evaporator
- 1.2.4 UV lamp 254 nm.

1.3 Reagents

- 1.3.1 Diethyl ether
- 1.3.2 Petroleum ether (boiling point ≤ 40 °C)
- 1.3.3 Methanol
- 1.3.4 Sulfuric acid, 20% (v/v)
- 1.3.5 Anhydrous sodium sulfate.
- 1.3.6 Ethanol, 96% (v/v) .
- 1.3.7 Chromatographic separation layer: 10 g polyamide powder with fluorescent indicator(e.g. polyamide DC II UV₂₅₄ from Macherey-Nagel) mixed vigorously with 60 mL methanol. Add while stirring, 10 ml of water and 10ml of silica gel (with fluorescent indicator), e.g. Kieselgel GF₂₅₄ Merck. Spread this mixture on 5 plates (200 x 200 mm) to a thickness of 0.25 mm. Dry the plates at room temperature for 30 minutes, then place in a 70°C oven for 10 min.
- 1.3.8 Migration solvent:
 - Crystallizable benzene60 vol.
 - Acetone 3 vol.
 - Crystallizable acetic acid 1 vol.

1.3.9 Reference solutions:

Dehydroacetic acid and benzoic acid, 0.2%, in alcoholic solution.

Sorbic acid, *p*-chlorobenzoic acid, salicylic acid, *p*-hydroxybenzoic acid and its propyl, methyl and ethyl esters, 0.1 % (*m/v*), in alcoholic solution.

1.4 Procedure

Acidify 100 mL of wine using 10 mL of 20% sulfuric acid (1.3.3), then proceed to extract 3 times using 50 mL of a (50:50) diethyl ether-petroleum ether mixture for each extraction. Remove the clear aqueous phase leaving an aqueous emulsion and the ether phase. Mix again the remaining liquid in the separation flask composed of an emulsion and the ether phase. The remaining aqueous phase usually separates clearly from the ether phase. If there is any residual emulsion, it should be eliminated by the addition of a few drops of ethanol.

The diethyl ether-petroleum ether phases recovered are washed with 50 mL water, dried using sodium sulfate, then evaporated by rotary evaporator, at 30 - 35 °C. The residue is recovered with 1 mL of ethanol.

Deposit 20 µL of this solution on the starting line in a 2 cm wide band, or 10 µL in a circular spot. For a comparison standard, deposit 5 µL of each of the reference solutions described above. After the chromatography (ascending height of migration 15 cm, duration 1 hour 15 min. to 1 hour 45 min., at normal saturation of the chamber), the plate is dried at room temperature. Any dehydroacetic acid and other preservatives present show up under a UV lamp at 254 nm.

When the examination of the chromatogram has revealed the presence of *para*-chlorobenzoic acid, the propyl or methyl esters of *para*-hydroxybenzoic acid which are only partly separated by this method may be identified consequently on the extract above, following the method described in *Examination of Sorbic, Benzoic, Parachlorobenzoic Acids*, 2.1. *Thin layer chromatography*.

BIBLIOGRAPHY

HALLER H.E., JUNGE Ch., *F.V., O.I.V.*, 1972, n° 397, *Mitt. Bl. der Gd CH, Fachgruppe, Lebensmitt. u. gerichtl. Chem.*, 1971, **25**, n° 5, 164-166.

Method OIV-MA-AS4-02F

Type IV method

Detection of preservatives and fermentation inhibitors

Method A 35 modified by resolution Oeno 6/2006

6. Sodium Azide

1.1 Method by high performance liquid chromatography

1.1.1 Principle

Hydrazoic acid isolated in wine using double distillation is identified after derivatization with 3,5-dinitrobenzoyl chloride, by high performance liquid chromatography. Detection is carried out by ultraviolet absorption spectrophotometry at 240 nm.

1.1.2 Apparatus

1.1.2.1 Distillation apparatus (distillation apparatus for determination of alcoholic strength); the end of the condenser terminating in a tampered tube

1.1.2.2 500 mL spherical flasks with ground glass necks

1.1.2.3 10 mL flask with a ground glass stopper

1.1.2.4 Apparatus for HPLC

– Operating conditions:

Column: C₁₈, 25 cm long.

Mobile Phase: acetonitrile-water (50:50)

Flow rate: 1 mL/min.

Volume injected: 20 µL

Detector: ultraviolet absorption spectrophotometer at 240 nm

Temperature: ambient

1.1.3 Reagents

1.1.3.1 Sodium hydroxide, 5% (*m/v*).

1.1.3.2 Sulfuric acid solution, 10% (*m/v*).

1.1.3.3 Indicator reagent: methyl red 100 mg, and methylene blue 50 mg, 100 mL alcohol, 50% (*v/v*).

1.1.3.4 Acetonitrile for chromatography.

1.1.3.5 Derivatizing reagent: 3,5-dinitrobenzoyl chloride, 10% (*m/v*), in acetonitrile.

1.1.3.6 Buffer solution of sodium acetate, pH 4.7: mix 1 volume of sodium acetate solution, NaC₂H₃O₂·3H₂O, 1 M, with 1 volume acetic acid solution, 1 M.

1.1.3.7 Sodium azide, NaN_3 .

1.1.4 Procedure

1.1.4.1 Preparation of the sample.

Into a spherical flask with a ground glass neck, place 100 mL of wine, distill by plunging the end of the condenser in 10 mL of 5% sodium hydroxide solution (1.1.3), to which are added a few drops of reagent indicator. Distill until 40-50 mL of distillate is recovered.

Transfer the distillate into another spherical flask (1.1.2.2), rinse the flask twice with 20 mL of water and add water to bring to 100 mL. To eliminate the ethanol, attach the flask to the distillation apparatus and eliminate about 50 mL of distillate (reduce the volume by half).

Cool the flask completely. Acidify with 10% sulfuric acid. Distill, recover the distillate into a 10 mL flask with a ground glass stopper containing 1 mL of water, and immerse in an iced bath. Stop the distillation when the total volume reaches 10 mL.

1.1.4.2 Derivatization

Mix 1 mL distillate (1.1.4.1), 0.5 mL of acetonitrile, 0.2 mL buffer solution and 30 μ L of derivatizing reagent and stir vigorously; leave for five minutes.

1.1.4.3 Chromatography

Inject 20 μ L in accordance with the conditions specified, the hydrazoic acid derivative has a retention time of about 11 minutes. Detection limit: 0.01 mg/L.

Note: Sometimes another substance not derivatized can simulate hydrazoic acid. It is necessary to verify a positive result as follows: inject 20 μ L of distillate directly; a disappearance of the peak indicates the presence of hydrazoic acid.

1.1.5 Calculation

To determine the concentration of sodium azide, compare the sample response to that of the standard solution after derivatization. Take into account the concentration factor 10 of the sample of wine at the time of analysis.

1.2 Colorimetric method

1.2.1 Principle

Hydrazoic acid, which is very volatile, is separated by double distillation, permitting the elimination of ethanol, acetic acid and sulfur dioxide. Then the amount is determined colorimetrically after forming a colored complex with ferric chloride (maximum absorbance at 465 nm).

1.2.2 Apparatus

1.2.2.1 Simple distillation apparatus, consisting of a 500 mL flask with a ground glass neck and a condenser ending in a pointed tube

1.2.2.2 Spectrophotometer with optical glass cells 1 cm path length

1.2.3 Reagents

1.2.3.1 Sodium hydroxide solution, 1 M

1.2.3.2 Sulfuric acid, 1 M

1.2.3.3 Hydrogen peroxide, 3% (v/v), whose strength must be adjusted just before use using a solution of potassium permanganate, 0.02 M; where p mL equals the volume which oxidizes 1 mL of the hydrogen peroxide solution, 3%

1.2.3.4 Ferric chloride solution at 20 g per liter of Fe III: (weigh 96.6 g of $\text{FeCl}_3 \cdot 6\text{H}_2\text{O}$, or more as this salt is very hygroscopic; control the concentration of Fe III of the solution and adjust if necessary to 20 ± 0.5 g per liter)

1.2.3.5 Stock solution of sodium azide, NaN_3 , at 1 g per liter in distilled water

1.2.3.6 200 mg per liter sodium azide solution prepared by dilution of the solution at 1 g per liter

1.2.4. Procedure

a) Into a 500 mL flask with a ground glass neck, place 200 mL of wine, distill, recover the distillate in a 50 mL volumetric flask, containing 5 mL water, which is immersed in an iced bath. Stop the distillation when the total volume reaches about 50 mL.

b) Transfer quantitatively the distillate into another 500 mL flask with a stopper and rinse the 50 mL flask twice with 20 mL of water.

Neutralize using 1 M sodium hydroxide solution (1.2.3.1) (using pH indicator paper).

Acidify using 10 mL 1 M sulfuric acid (1.2.3.2), mix, then oxidize the sulfur dioxide by adding 3% hydrogen peroxide solution (1.2.3.3.).

If the wine contains S mg per liter of sulfur dioxide, and if p mL is the volume of 0.02 M potassium permanganate solution necessary to oxidize 1 mL of 3% hydrogen peroxide solution, then for 200 mL of wine use the following calculation:

$$\frac{S}{5 \times 3.2p} = \frac{S}{16p} \text{ mL of H}_2\text{O}_2 \text{ solution}$$

Bring the volume to about 200 mL by addition of distilled water.

Distill, recover the distillate in a 50 mL glass flask containing 5 mL distilled water, which is immersed in an ice bath; stop the distillation before the measurement line, bring back to ambient temperature and adjust the volume to 50 mL.

c) Add 0.5 mL (measured exactly) of ferric chloride solution, mix and measure immediately (maximum delay 5 min.) the absorbance at 465 nm in

a 1 cm cell; the zero of the apparatus is set using a blank composed of 50 mL of water added to 0.5 mL of ferric chloride solution.

d) Preparation of the standard curve.

Into each of five 50 mL volumetric flasks add 1, 2, 3, 4, and 5 mL of 200 mg/L sodium azide solution respectively, bring the volume to 50 mL with distilled water, add 0.5 mL of ferric chloride solution and measure the absorbance at 465 nm.

These solutions contain 4, 8, 12, 16, 20 mg of sodium azide per liter. The corresponding concentrations are 1, 2, 3, 4, and 5 mg per liter of wine.

The typical curve of absorbance variation as a function of concentration is a straight line passing through the origin.

1.2.5 Calculation

Plot the absorbance read for the sample analyzed on the straight line and interpolate the concentration of sodium azide in mg/L of wine.

BIBLIOGRAPHY

HPLC method:

SEARIN S.J. & WALDO R.A., *J. Liquid. Chrom.*, 1982, **5**(4), 597-604.

BATTAGLIA R. & MITISKA J., *Z. Lebensm. Unters. Forsch.*, 1986, **182**, 501-502.

Colorimetric method:

CLERMONT S. & CHRETIEN D., *F.V., O.I.V.*, 1977, n° 627.

Enumerating yeasts of the species *Brettanomyces bruxellensis*
using qPCR

(Oeno 414-2011)

Warning to users

Phenol: All handling procedures involving phenol must be performed under a fume hood and gloves must be worn. All phenol-contaminated residues must be collected in suitable containers.

SYBR Green: This displays a non-zero mutagenicity, but one which is lower than that of ethidium bromide. The precautions for use must nevertheless be adhered to.

1. Scope of application

This protocol describes a method for enumerating yeasts of the species *Brettanomyces bruxellensis* in wine in bulk or bottled wines, using real-time qPCR (quantitative polymerase chain reaction) (qPCR). The analysis of wines during AF (alcoholic fermentation) and of musts has not yet been validated.

2. Definition

The micro-organisms enumerated by this method are *Brettanomyces bruxellensis* yeasts which have a copy of the target gene

3. Principle

The PCR technique amplifies, by multiple repetition of an enzymatic reaction, a target DNA (deoxyribonucleic acid) region identified by two primers. The process involves repeating a three-step cycle:

- Denaturing the DNA by heating
- Hybridization of the primers
- Polymerization, carried out by the *Taq* (*Thermophilus aquaticus*) polymerase

However, unlike traditional PCR, qPCR can quantify the DNA amplified during the amplification process through the use of a fluorophore.

COMPENDIUM OF INTERNATIONAL ANALYSIS OF METHODS – OIV
Enumerating yeasts of the species *Brettanomyces bruxellensis*
using qPCR

Until now two regions specific to the species have been used as targets. One region is the encoding gene for the 26S ribosomal RNA (ribonucleic acid) and the other the *RAD4* gene [2, 3]. As with the FISH method, PCR is specific to *Brettanomyces bruxellensis* but has the advantage of being less expensive.

The distinctive feature of qPCR is that it is possible to read, after each amplification cycle, the fluorescence which increases exponentially as the DNA amplification proceeds. Many fluorescence techniques have been developed for this application. The SYBR[®] Green fluorophore has been found to be suitable for use with *Brettanomyces*.

❖ SYBR[®] Green fluorophore

This agent fluoresces strongly when it inserts itself non-specifically between the nucleotides in the double-stranded DNA. In contrast, it fluoresces only weakly when unbound. Using this technology, a merged curve can be generated at the end of the amplification that validates the specificity of the reaction.

❖ Internal standard

In order to validate the DNA extraction and amplification stages, an internal standard has been integrated into the method (Lip4 *Yarrowia lipolytica*).

4. Reagents and products

All plastic consumables must be autoclaved beforehand to destroy any DNases (deoxyribonucleases), as must the Tris-HCl and TE (Tris EDTA, ethylene diamine tetra-acetic acid) buffer solutions, the ammonium acetate and the ultrapure water (18 MΩ). All the aqueous solutions are prepared using ultrapure water (18 MΩ). Some solutions are sterilized in an autoclave (indicated as "autoclaved"). Sterile ultrapure water (18 MΩ) is used, if possible, to prepare any solutions which are not autoclaved. It is not then necessary to work under sterile conditions.

- **PVPP** (eg: ISP Polyclar Super R or Sigma P6755-100G),
- **Solutions at room temperature:** Tris-HCl buffer, 10mM pH8, solution I (Tris-HCl 10mM pH8, EDTA 1mM, NaCl 100mM, SDS 1% (sodium

**COMPENDIUM OF INTERNATIONAL ANALYSIS OF METHODS – OIV
Enumerating yeasts of the species *Brettanomyces bruxellensis*
using qPCR**

dodecyl sulfate), Triton X-100 2%), TE (Tris-HCl 10 mM pH8, EDTA 1mM) autoclaved, 4M ammonium acetate, absolute ethanol,

- Provide **one autoclaved, sterilized ultrapure (18 MΩ) water bottle** (20mL) per qPCR plate,
- **Solutions at 4°C**: saturated phenol pH8: chloroform: IAA (isoamyl alcohol 24:25:1) and Rnase (ribonuclease) 1µg/µL
- **Suspension at -20°C**: internal standard, SYBR Green (e.g. iQ SBYR Green Supermix Bio-Rad 170-8884), primers 4µM Brett rad3, Brett rad4, YAL-F and YAL-R each one.
- **Dry bath, set to 37°C.**

All handling procedures involving phenol must be performed under a fume hood and gloves must be worn. All phenol-contaminated residues must be collected in suitable containers.

<u>PCR substances</u>	<u>Specifications</u>	<u>CAS Number</u>
4.1 ammonium acetate	>98%	631-61-8
4.2 phenol:chloroform:IAA (24:25:1)	Ultra	136112-00-0
4.3 proteinase K	1215 U/mg proteins (16.6 ng/ml)	39450-01-6
4.4 SDS	>99% Ultra	151-21-3
4.5 Tris base	>99.8% Ultra	77-86-1
4.6 BSA	Molecular biology grade	9048-46-8
4.7 saturated phenol pH 8		108-95-2
4.8 PVPP 360kDa		9003-39-8
4.9 RNase A	70 U/mg in solution	9001-99-4
4.10 TE pH8	Ultra	Tris : 77-86-1 EDTA : 60-00-4
4.11 Primers 25nmol		-

5. Apparatus

- **Plastic consumables:** 2mL screw-capped microtubes, 1.5 and 1.7mL microtubes, white (10 µL), yellow (200 µL) and blue (1000 µL) pipette tips for micropipettes P20, P200, P1000, P5000, 96-well PCR microplates and optical film, non-powdered gloves
- **Glass beads** (Ø 500 µm)
- **Bottle** (20mL) autoclaved (for ultrapure [18 MΩ] sterilized water, one per qPCR plate),
- 15 and 50 mL **Centrifuge tubes**
- **Equipment:**
 - automatic pipettes (P20, P200, P1000, P5000)
 - microtube centrifuge
 - automatic stirrer to split cells (eg. GenieDisruptor)
 - Thermocycler coupled to a spectrofluorimeter (optical system to detect the fluorescence generated during the real-time PCR reactions)
 - Magnetic stirrer
 - Stop watch
 - dry bath set to 37°C
 - autoclave
 - 100mL volumetric flasks
 - 50mL volumetric flasks
 - 10mL volumetric flasks
 - 100mL beakers
 - 50mL beakers
 - 10mL beakers
 - Magnetic stirring bars

6. Sampling (sample preparation)

6.1. Enumerating the samples:

The samples are removed either directly into bottles for analysis or into pre-sterilized sample flasks.

No interference with the method has been observed from the yeasts tested (including K1 and L2056) when the yeast populations are not greater than 5.10^6 CFU/mL (colony forming units). There is no data for populations larger than this figure; consequently, avoid measuring wines during AF.

NB: When enumerating yeasts using standard microbiology methods of analysis (growth in agar growth medium, optical density), the results are expressed in CFU/mL (colony forming unit). Conversely, enumeration resulting from the analysis by qPCR is expressed in GU/mL (genetic unit).

6.2. Preparing the internal standard

Grow *Yarrowia* in liquid YPD (yeast peptone dextrose) at 28°C up to an OD₆₀₀ (optical density at 600 nm) of 1 (approximately 48 hrs).

After estimating the OD_{600 nm} dilute to 1.0×10^6 CFU/mL in isotonic saline solution ($1 \text{ OD} = 1.0 \times 10^7$ CFU/mL).

Transfer a 110µL sample of the 1.0×10^6 CFU/mL culture into a 1.7mL microtube and add 110µL of 40 % glycerol to obtain a population of 5.0×10^5 CFU/mL. Mix and store at -80°C. One tube can be used to process 5 wine samples.

Perform an enumeration simultaneously to check the titer of the suspension.

6.3. Preparing the solutions

100mL of Tris-HCl pH8 10 mM: weigh 0.121 g of tris base (eg. Trizma base) and dissolve in 80mL of ultrapure [18 MΩ] water. Adjust the pH using HCl. Make up to 100mL. Autoclave.

100mL TE: weigh 0.121 g of tris base and dissolve in 80mL of water. Adjust the pH using HCl. Add 37.2 mg of EDTA. Adjust the pH to 8 (to assist the dissolution of the EDTA) then make up to 100mL. Autoclave.

COMPENDIUM OF INTERNATIONAL ANALYSIS OF METHODS – OIV
Enumerating yeasts of the species *Brettanomyces bruxellensis*
using qPCR

100mL solution I: prepare 50mL of TE 2x and add 10mL of 1M NaCl, 10mL of SDS 10% (dissolved by heating gently) and 2 g of Triton X100, then make up to volume.

4M ammonium acetate: dissolve 15.4 g of ammonium acetate in 50 mL ultrapure [18 MΩ] water qs to 50mL.

100mL phenol:chloroform:IAA (25:24:1): add 48mL of chloroform and 2mL of isoamyl alcohol to 50mL of phenol saturated with TE buffer pH8. Store at 4°C.

RNase A 1µg/µL: dilute a 70U/mg solution of RNase A (e.g. Sigma, R4642-50MG, stored at -20°C) with ultrapure [18 MΩ] water. The specified concentration of the RNase stock is indicated on the tube and in the specification sheet for the batch. The diluted solution should be kept at not more than 4°C for up to 3 weeks.

Brett 4µM primers: using 100 µM stock solutions of primers (in the supplier's tubes), mix 4 µM Brett rad3 (GTTACACAATCCCCTCGATCAAC) and 4 µM Brett rad4 (TGCCAACTGCCGAATGTTCTC) qs to 1mL with ultrapure [18 MΩ] water). Store for up to 1 year at -20°C.

YAL 4µM primers: using 100 µM stock solutions of primers (in the supplier's tubes), mix 4 µM YAL-F (ACGCATCTGATCCCTACCAAGG) and 4 µM YAL-R (CATCCTGTGCTCTTCCAGGTT) qs to 1mL with ultrapure [18 MΩ] water). Store for up to 1 year at -20°C.

7. Procedure

Sample to be analyzed: shake the bottle to homogenize its contents.

For a corked bottle: disinfect the neck of the bottle with 70% alcohol and uncork over a naked flame, using a corkscrew disinfected with 70% alcohol.

Transfer a 15-20mL sample of the wine into a 30-mL, sterile, plastic, single-use bottle.

The steps at which the protocol may be paused are identified by a * (max. interruption time, T°).

7.1. Separating the cells

This step must be duplicated.

The handling procedures must be carried out under a confined microbiological safety cabinet dedicated to this purpose.

- take a **1mL sample of wine** and transfer to a 2mL screw-capped microtube
- add 20µL of internal standard, at a concentration of 5.0×10^5 CFU/mL
- centrifuge for **30 sec. at 9,300g**
- eliminate the supernatant by gently inverting the microtube
- suspend the pellet in **1mL of Tris-HCl 10 mM pH 8**
- centrifuge for **30 sec. at 9,300g** and eliminate the supernatant.
- vortex briefly to suspend the pellet in the residual fluid * (3 months, -20°C).
-

One tube will be used for extracting the DNA and the other will be stored at -20°C until validated results have been obtained.

7.2. Extracting the DNA

From a fresh or frozen pellet. Do not process more than 24 samples at the same time.

- add **PVPP** (1% of final mass/volume) by weighing add **0.3 g** of **200-500µm glass beads**
- add **200µL of solution I**
- add **200µL of phenol:chloroform:IAA (24:25:1)**
- disrupt the cells with the automatic stirrer (for example a **GenieDisruptor**) **4x80 sec.** with cold intervals (-20°C refrigerated unit) lasting for about 80sec between each disruption phase
- add **200µL of TE**
- centrifuge for **5min at 15700g**.
- **carefully** collect 400µL of the upper aqueous phase in a 1.7mL microtube. **If the two phases mix, repeat the centrifugation step.**
- add **1mL of absolute ethanol** and mix the tube by inversion 4-5 times * (a few hours, room T°)
- centrifuge for **5 minutes at 15700g** and eliminate the supernatant by inverting the microtube
- suspend the pellet in **400µL of TE and 30µL of RNase at a concentration of 1 µg/µL**
- incubate the solution at **37°C for 5 minutes (then readjust to 48°C)**
- add **10µL of 4M ammonium acetate + 1mL of absolute ethanol**; mix by inversion
- centrifuge for **5 minutes at 15700g**

COMPENDIUM OF INTERNATIONAL ANALYSIS OF METHODS – OIV
Enumerating yeasts of the species *Brettanomyces bruxellensis*
using qPCR

- eliminate the supernatant by inversion; use filterpaper to absorb the final drops
- dry the pellet (leave the open tube in the dry bath at 48°C, for approximately 1 hour)
- add 25µL of TE to the pellet, vortex and leave at 4°C for between 1 and 18 hrs (to assist the solubilisation of the DNA). Mix using the automatic stirrer * (a few weeks, -20°C)

7.3. qPCR

For each sample of wine, provide 2 wells with Brett rad3/4 primers and 2 internal standard wells with YAL primers. For each plate, provide a negative control with TE for each pair of primers to be carried out as the final operation. Also perform a positive control on the *Brettanomyces bruxellensis* DNA available at -20°C. To prepare the positive control, add 5µL stock solution (4.5 UG / ml) in a final reaction volume of 25 µL.

PCR amplification programme:

<u>Cycle number</u>	<u>Time (seconds)</u>	<u>Temperature (°C)</u>
1	180	95
40	30	95
	10	64.6
<u>The merged curve is established after 90°C by reducing the heat by 0.5°C every 10 seconds</u>		

**COMPENDIUM OF INTERNATIONAL ANALYSIS OF METHODS – OIV
Enumerating yeasts of the species *Brettanomyces bruxellensis*
using qPCR**

Num. of Brett wells = Num. of YAL wells = 2 x no. of samples + 2

The table below indicates, as a function of the number of samples, the number of wells and the quantity of each constituent of the mixture.

number of samples	number of wells	water at 18 MΩ (μL)	iQ SYBR Green Supermix (μL)	Mixture of 4 μM primers (μL)
1	4	26.3	65.6	13.1
2	6	36.8	91.9	18.4
3	8	47.3	118.1	23.6
4	10	57.8	144.4	28.9
5	12	68.3	170.6	34.1
6	14	78.8	196.9	39.4
7	16	89.3	223.1	44.6
8	18	99.8	249.4	49.9
9	20	110.3	275.6	55.1
10	22	120.8	301.9	60.4
11	24	131.3	328.1	65.6
12	26	141.8	354.4	70.9
13	28	152.3	380.6	76.1
14	30	162.8	406.9	81.4
15	32	173.3	433.1	86.6
16	34	183.8	459.4	91.9
17	36	194.3	485.6	97.1
18	38	204.8	511.9	102.4
19	40	215.3	538.1	107.6
20	42	225.8	564.4	112.9
21	44	236.3	590.6	118.1
22	46	246.8	616.9	123.4
23	48	257.3	643.1	128.6

COMPENDIUM OF INTERNATIONAL ANALYSIS OF METHODS – OIV
Enumerating yeasts of the species *Brettanomyces bruxellensis*
using qPCR

- remove the Brett 4 μ M and the YAL 4 μ M primers from the freezer
- remove the SYBR Green (4°C if tube in current use, otherwise –20°C)
- prepare a Brett mixture and a YAL mixture using the quantities shown in the table above as a function of the number of samples.
- apply 20 μ L of mixture to the bottom of each well
- add 5 μ L of homogenized DNA solution to the automatic stirrer (or 5 μ L of water for the negative controls)
- adjust the optical film and load the plate

7.4. Reading the results

- remove the plate and place it directly in the bag for disposal (**do not open it**)
- set the baseline to 100.
- analyze (in the order indicated below):
 - o the negative controls, which should not produce a signal. If a Ct of less than 37 is observed, repeat the process, changing all the solutions,
 - o the positive control on Brett: its Ct must be approximately 25, with a melting point of 82.5°C (\pm 0.5°C),
 - o YAL internal standards: if a Ct is obtained, check the melting point of the product (84°C \pm 0.5°C). If the product does not conform, the absence of a Brett signal cannot be interpreted,
 - o samples: check the Tm of the *Brettanomyces bruxellensis* product (82°C \pm 0.5°C). If and only if the Tm is acceptable, check the exponential profile of the amplification. Then record the Ct values and plot them onto the standard curve.

NB: the Ct represents the time needed for the fluorescence of the target sequence to reach a threshold value. Consequently, it is the minimum number of PCR cycles required for the fluorescent signal to emerge from the background noise.

8. Calculations (Results)

Five *Brettanomyces bruxellensis* strains were inoculated at different concentrations, from $3,1 \times 10^5$ to 3 UFC/mL, on 14 wines (3 white wines, 2 rosé wines, 9 red wines whose phenolic compound content varied widely). The DNA was then extracted in the presence of 1% PVPP.

COMPENDIUM OF INTERNATIONAL ANALYSIS OF METHODS – OIV
Enumerating yeasts of the species *Brettanomyces bruxellensis*
using qPCR

A standard curve was established from the set of results obtained on the different combinations of wines and strains.

The results are obtained in GU/mL (genetic unit/mL) from the standard curve

$$\log GU = -\log(2.03) \times Ct + 12.34$$

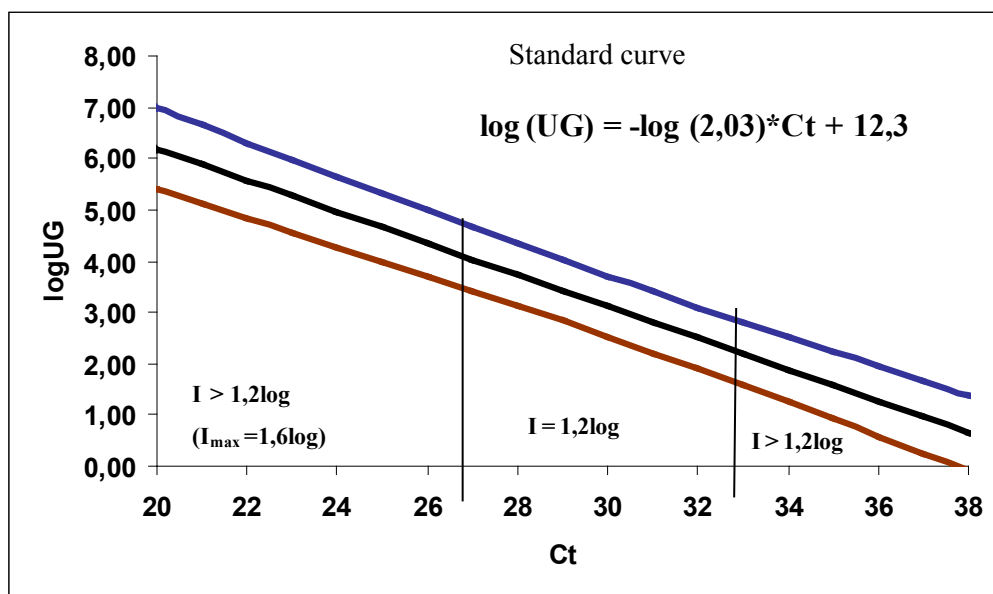

9. Method characteristics: intra-laboratory validation parameters

9.1. Linearity, repeatability and reproducibility [4]

The six-point calibration curve was prepared in the range of 0 to 2×10^5 CFU/mL of the L0211 strain in a wine with four replicates. This population range was selected according to the usual levels of *Brettanomyces bruxellensis* in wines. The measured log GU vs. theoretical log GU relationship was described by simple regression analysis. Regression parameters, slope and intercept were determined as shown in the Table below. The regression model was accepted with a risk $\alpha=1\%$ and the chosen linearity domain validated since no model error was detected.

COMPENDIUM OF INTERNATIONAL ANALYSIS OF METHODS – OIV
Enumerating yeasts of the species *Brettanomyces bruxellensis*
using qPCR

Fidelity of the method was compared to that obtained with the classical culture method. Three operators prepared DNA extracted from a wine inoculated with the L02I1 strain at two levels: 1.9×10^4 (high) or 1.9×10^2 (low) CFU/mL. Four repeats of PCR were performed for each DNA extract. The standard deviation for repeatability and reproducibility, respectively S_r and S_R , were calculated from log GU values for both levels (table below). For the qPCR method, both S_r and S_R were similar for the low population level, but S_R was greater than S_r at high population levels. Both standard deviations were twice as high as those obtained with the classical microbiology method. This effect was attributed to the increased number of steps during the qPCR method.

Table

Parameter	Values
Regression equation	
Range (CFU/mL)	0 to 2×10^5
Slope (\pm SD)	0.957 (0.044)
Intercept (\pm SD)	-0.049 (0.142)
Regression model	$F_{obs} > F(1.18)$: Linear model accepted
Model error	$F_{obs} < F(4.18)$: No model error
Fidelity	
S_r qPCR (low/high)	0.26/0.25
S_r microbio (low/high)	0.17/0.04
S_R qPCR (low/high)	0.29/0.41
S_R microbio (low/high)	0.17/0.04
Accuracy	
Mean 43 samples (D)	2.39 (qPCR)/2.25 (microbio)
S_R D	1.18
Equality test $W=D/S_R$ D	$0.11 < 3$ accuracy acceptable

9.2. Limit of detection (LoD) and limit of quantification (LoQ) [4]

LoD and LoQ indicate the sensitivity of the method. LoD is the lowest population detected by the method; LoQ is the minimum of the population that can be quantified accurately. In food product analysis, these parameters are calculated from the background. However in qPCR there is no

background. We thus used two other approaches to evaluate LoD and LoQ. The first method uses slope, intercept and standard error on intercept obtained from linearity validation experiments. With this method, LoD and LoQ values of 3 and 31 GU/mL respectively were obtained. In the second approach, the LD was obtained from the population level resulting in one negative result from 10 independent measurements. Analysis of our data obtained from 14 wines inoculated with five strains revealed that 96% of samples (48/50) containing 101 to 250 CFU/mL resulted in positive signals, while 83% (49/59) were positive if they contained 26 to 100 CFU/mL and 65% (44/68) if 5 to 25 CFU/mL. Thus the limit of detection evaluated from this method would be in the range of 26-100 CFU/mL. By the systematic repetition of each PCR assay, an LoD of 5 CFU/mL was certified thanks to probability calculations $(1 - p)^2$. Indeed for 5 CFU/mL, 88% of samples were positive. This increased to 97% for 25 CFU/mL.

10. References

1. Phister T.G., Mills D.A., 2003. Real-time PCR assay for detection and enumeration of *Dekkera bruxellensis* in wine. *Applied and Environmental Microbiology*, 69: 7430-7434.
2. Cocolin L., Rantsiou K., Iacumin L., Zironi R., Comi G., 2003. Molecular detection and identification of *Brettanomyces/Dekkera bruxellensis* *Brettanomyces/Dekkera anomalus* in spoiled wines. *Applied and Environmental Microbiology*, 70: 1347-1355.
3. Ibeas J.I., Lozano I., Perdignes F., Jimenez J., 1996. Detection of *Dekkera-Brettanomyces* strains in sherry by a nested PCR method. *Applied and Environmental Microbiology*, 62: 998-1003.
4. Tessonière H., Vidal S., Barnavon L., Alexandre H., Remize F., 2009. Design and performance testing of a real-time PCR assay for sensitive and reliable direct quantification of *Brettanomyces* in wine. *International Journal of Food Microbiology*, 129: 237-243.

Differentiation of Fortified Musts and Sweet Fortified Wines

1. Principle of the method

1.1 Method of screening

The product definitions given by the O.I.V. (International Code of Enological Practices) imposes for fortified wines, a minimum of 4% acquired alcohol derived naturally by fermentation; and allows, for fortified musts, a maximum of 1% acquired alcohol. Consequently, these products may be differentiated by identifying their fermentation by-products via gas chromatography.

This method is applicable only if, as the definition anticipates, the alcohol used for production of the fortified musts is neutral.

1.2 Scientific investigation of citramalic acid by thin layer chromatography.

The presence of citramalic acid characterizes sweet fortified wines. Its identification is carried out by thin layer chromatography after separation of the sugars with the use of an ion exchange column.

2. Method of screening

2.1 Apparatus

Gas chromatograph with:

- Flame ionization detector,
- 3 m stainless steel column, 2 mm interior diameter,
- Stationary phase: Carbowax 20 M 20%,
- Support: Chromosorb W 60/80 mesh.

Chromatography conditions:

- temperatures:
 - injector: 210°C
 - detector: 250°C
 - oven: isothermal at 70°C for 6 minutes; then programmed at 6°C/minute;
 - upper temperature limit: 170°C

Other types of columns can be used.

The procedure described below is given as an example.

2.2 Procedure

2.2.1. Sample preparation

Carry out a separation according to the following conditions: To 25 mL of sample (fortified must or sweet fortified wine) are added to 7 mL ethanol and

15 g of ammonium sulfate, (NH₄)₂SO₄, agitate. Allow to settle to obtain separation of the phases.

2.2.2 Chromatography

Inject 2 µL of the organic phase and carry out the chromatography in accordance with the conditions indicated above.

The chromatogram of the fortified wine is differentiated by the presence of the peaks of the secondary products of alcoholic fermentation.

3. Investigation of citramalic acid by thin layer chromatography.

3.1 Apparatus

3.1.1 Glass column about 300 mm in length and 10-11 mm interior diameter supplied with a flow regulator (stopcock)

3.1.2 Rotary vacuum evaporator

3.1.3 Oven at 100 °C

3.1.4 Chromatography developing chamber

3.1.5 Micrometric syringe or micropipette

3.2 Reagents

3.2.1 Formic acid solution, 4 M, containing 150.9 mL formic acid ($\rho_{20} = 1.227$ g/mL) per liter.

3.2.2 Plates for chromatography ready to use with a layer of cellulose powder (for example MN 300) (20 x 20 cm).

3.2.3 Solvent:

iso-Propyl alcohol containing 1 g/L bromophenol blue 5 vol.

Eucalyptol 5 vol.

Formic acid ($\rho_{20} = 1.227$ g/mL) 2 vol.

Saturate the solvent with water and allow to stand for 24 hours before use.

3.2.4 Standard solutions.

Prepare an aqueous solution of:

Citramalic acid 0.25 g/L

Lactic acid 0.5 g/L

Citric acid 0.5 g/L

Tartaric acid 1.0 g/L

Malic acid 1.0 g/L

3.3 Procedure

3.3.1 Preparation of the ion exchange column.

See chapter on *Tartaric acid*, usual method in 3.3.1.

3.3.2 Isolation of the organic acid of citramalic acid

Proceed as indicated in the chapter *Tartaric acid*, usual method in 3.3.2. for the fixation of organic acids on the ion exchanger.

Then elute the fixed acids using the 4 M formic acid solution (100 mL), collecting the eluate in a 100 mL volumetric flask.

Concentrate the eluate dry in a rotary evaporator at 40°C recovering the residue with 1 mL of distilled water.

3.3.3 Chromatography

The cellulose plate must be activated by placing it in the oven at 100°C for 2 hours.

Deposit on the starting line of the cellulose plate in a band 2 cm wide, 10 µL of this solution as well as 10 µL of the standard solutions of citramalic acid and the other organic acids.

Place the plate in the chromatography bath, above the solvent, for 45 minutes.

Proceed with the development and let the solvent migrate to a height of 15 cm.

3.3.4 Development of the chromatogram

Maintain the plate at ambient temperature under an air current, until the formic acid of the solvent is eliminated. Yellow spots appear on a blue background, indicating the presence of the acids.

Detect the presence or absence of citramalic acid in the product analyzed by comparing the spots of this chromatogram to the spots of standard solutions of citramalic acid and the other organic acids.

BIBLIOGRAPHY

Method of Screening:

HARVALIA A., *F.V., O.I.V.*, 1980, n° 728 bis.

Chromatography of citramalic acid:

DIMOTAKI-KOURAKOU V., *Ann. Fals. Exp. Chim.*, 1960, **53**, 149.

DIMOTAKI-KOURAKOU V., *C. R. Ac. Sci.*, Paris 1962, **254**, 4030.

CARLES J., LAMAZOU-BETBEDER M. & PECH M., *C. R. Ac. Sci.*, Paris 1958, **246**, 2160.

CASTINO M., *Riv. Vit. Enol.*, 1967, **6**, 247.

KOURAKOU V., *F.V., O.I.V.*, 1977, n° 642.

JUNGE Ch *F.V., O.I.V.*, 1978, n° 679.

ROUEN J., *F.V., O.I.V.*, 1979, n° 691.

Annex B

Certificates of analysis

Rules for the implementation of the analytical methods

The control of the quality of wines should always allow, on one hand, a sensory examination and, on the other hand, the determination of the essential characteristic elements of their composition.

Sensory analysis has not been studied in the present book; it is left to the evaluation of the various countries, but is required in every case.

With regard to the elements of the composition of wines, three types of determinations can or must be performed:

1. The determinations that serve to identify the wines and can serve as basis of commercial transactions (Certificate no. 1);
2. The determinations that permit us to ascertain satisfactorily the qualities and characteristics of a wine and which, in this manner, correspond to trade practices (Certificate no. 2).

Determinations other than anticipated in the Certificates numbers 1 and 2 can be required within a contractual framework.

3. A third Certificate (no. 3) can be considered which would contain specific determinations that are only carried out on an exceptional or special basis.

Resorting to the determinations aimed at Certificate no. 2 could be such as to exonerate the operators from liability.

The recourse to the determinations of the Certificate no. 3 could be such as to exonerate importers from liability.

When the public health is involved, other determinations can be required either by the OIV, the public authorities, or by all interested parties when serious doubts appear in the industry or among consumers.

The public health exception may be submitted, by all parties interested, to the special group of scientific experts of the Office according to an emergency procedure.

The analytical determinations are performed, when they exist, according to the methods described in the present book.

Certificates of Analysis

Certificate No. 1

- Color
- Clarity
- Specific gravity at 20°C
- Alcoholic content at 20°C
- Total dry extract g/L
- Sugar g/L
- Total sulfur dioxide mg/L
- pH
- Total acidity meq/L
- Volatile acidity meq/L
- Test for malvidin diglucoside
- Over pressure measurement of carbon dioxide in sparkling wines
- Differentiation of very sweet wine and fortified must in the case of sweet wines

Certificate No. 2

Certificate No. 1 is completed and the following determinations are added:

- Ash and alkaline ash g/L
- Potassium g/L
- Iron mg/L
- Copper mg/L
- Free sulfur dioxide mg/L
- Sorbic acid mg/L
- Verification of malolactic fermentation
- Citric acid mg/L
- Tartaric acid g/L
- Folin-Ciocalteu Index
- Chromatic Indexes

The following determinations are optional:

- Excess sodium mg/L
- Calcium, magnesium mg/L
- Sulfates mg/L
- Test of fermentability
- Test for artificial colorants

Annex C

**Maximum acceptable limits
of various substances**

**Maximum acceptable limits of various substances
contained in wine**
(2019 Issue)

Citric acid:	1 g/L
Volatile acidity:	20 milliequivalents/L The volatile acidity of various specially fortified old wines (wines subject to special legislation and controlled by the government) may exceed this limit.
Arsenic:	0.2 mg/L
Boron:	80 mg/L (expressed as boric acid)
Bromine:	1 mg/L (limit exceeded by way of exception in wines from certain vineyards with a brackish subsoil).
Cadmium:	0.01 mg/L
Copper: (oen 434-2011)	1 mg/L 2 mg/L for liqueur wines produced from unfermented or slightly fermented grape must
Diethylene glycol:	≤ 10 mg/L, to the quantification limit
Malvidol diglucoside:	15 mg/L (determined by the quantitative method diglucoside described in the Compendium)
Silver	< 0.1 mg/L

COMMENDIUM OF INTERNATIONAL METHODS OF ANALYSIS-OIV
Maximum acceptable limits of various substances contained in wine

Total sulfur dioxide at the time of sale to the consumer: (oenos 9/98)	
	<ul style="list-style-type: none">- 150 mg/L for red wines containing a maximum of 4 g/L of reducing substances.- 200 mg/L for white and rosé wines containing a maximum of 4 g/L of reducing substances.- 300 mg/L: red, rosé and white wines containing more than 4 g/L of reducing substances.- 400 mg/L: in exceptional cases some sweet white wines.

Ethanediol /Ethylene glycol:	≤ 10 mg/L
------------------------------	-----------

Fluoride: (oenos 8/91)	1 mg/L except for wines coming from vineyards treated in conformity with national law, with cryolite in which case, the level of fluoride must not exceed 3 mg/L.
------------------------	---

Methanol:	400 mg/L for red wines
(oenos 19/2004)	250 mg/L for white and rosé wines

Ochratoxin A :	2 µg/L (for wines obtained as from the 2005 harvest)
(CST 1/2002)	

Lead: (oenos 638/19)	0.10 mg/L for wine, produced starting from the 2019 harvest year
	0.15 mg/L for liqueur wines, produced starting from the 2019 harvest year ¹

¹ For liqueur wines subject to extended periods of aging, the applicable limit is that in force at the time of their production.

COMMENDIUM OF INTERNATIONAL METHODS OF ANALYSIS-OIV
Maximum acceptable limits of various substances contained in wine

Propan-1,2-diol/propylene glycol (oen 20/2003)	Still wines : = 150 mg/L Sparkling wines : = 300 mg/L
---	--

Excess sodium: (oen 09/2007)	80 mg/L
---------------------------------	---------

Sulfates: (expressed as potassium sulfate)	1 g/L	
	However this limit is raised to:	
	- for wines which have undergone a maturing period in casks for at least 2 years	} 1.5 g/L
	- for sweetened wines	
	- for wines obtained by the addition to the musts or wine of alcohol or potable spirit	
- for wines with added concentrated musts	} 2.0 g/L	
- for naturally sweet wines		
	- for wines obtained under a film "sous voile"	} 2.5 g/L

Zinc	5 mg/L
------	--------

Annex D

Advices

Gluconic acid

Resolution oeno 4/91

Gluconic acid is always present in musts and wines.

In wines derived from a sound, mature harvest, its level does not exceed 200—300 mg/L.

Gluconic acid increases through over—ripening by raisining and especially by the intervention of *Botrytis cinerea*.

Its presence at higher levels in wines — other than wines infected with noble rot of which gluconic acid is a characteristic constituent — cannot be considered a sign of bad quality linked to a harvest seized with gray rot, which must be demonstrated by other means. In fact, by appropriate vinification techniques, it is possible to obtain wines of quality in this case.

As to fraud by addition of gluconic acid, this is not a factor to be taken into account since there is no reason for it.

Characterization of wines resulting from overpressing

Resolution oeno 5/91

NOTICE

In view of the results of the discussions concerning the tests on DESCRIPTIVE CHARACTERISTICS OF WINES RESULTING FROM OVERPRESSING, the experts have confirmed that, for the group of tests done, the behavior of wines is very different depending on the variety. This renders impossible all interpretation concerning wines coming from several varieties.

Moreover, the effects of the different methods of pressing and of vinification techniques, such as prefermentation maceration, must be taken into account.

Studies must be pursued to show wines resulting from overpressing and a definition of overpressing sought after.

The level of sodium and chloride ions in wines

Resolution Oeno 6/91

NOTICE

The level of Chloride and sodium ions in wines essentially depends on the geographic, geologic and climatic conditions of vine culture.

As a general rule, the levels of these ions are low.

the content of these elements is increased in wines coming from vineyards which are near the sea coast, which have brackish sub—soil or which have arid ground irrigated with salt water and the molar ratio of Cl/Na⁺ therefore varies significantly and can even have a value close to one (1) which could imply the addition of salt (NaCl) to the wine.

When wine contains excess sodium (excess sodium is equal to the content of sodium ions less the content of chloride ions expressed as sodium), it is generally less than 60 mg/L, a limit which may be exceeded in exceptional cases.

The laboratories and official control agencies, confronted with elevated levels of Cl and/or Na⁺, must take the above conclusions into account and possibly make inquiries to the official agencies of the country *of origin* before expelling these wines.

Annex E

**Laboratory quality
assurance**

**Principle of validation of routine methods with respect to
reference methods**
(Resolution Oeno 7/98)

The OIV acknowledges the existence of methods of analysis of wines in addition to those described in the Summary of International Methods of Analysis of Wines and Musts, of common methods most often automated. These methods are economically and commercially important because they permit maintaining a complete and efficient analytical framework around the production and marketing of wine. Moreover, these methods allow the use of modern means of analysis and the development and adaptation of techniques of analysis.

In order to allow laboratories to use these methods and to insure their linkage to methods described within the Summary, the OIV decides to establish a plan of evaluation and validation by a laboratory of an alternative, common method, mechanized or not with respect to a reference method described in the Summary of International Methods of Analysis of Wines and Musts.

This principle, which will be adapted to the particular situation of the analysis of wines and musts, will take its inspiration from international standards in current use and allow the laboratory to assess and validate its alternative method in two ways:

Collaborative Study

The purpose of the collaborative study is to give a quantified indication of the precision of method of analysis, expressed as its repeatability r and reproducibility R .

Repeatability: the value below which the absolute difference between two single test results obtained using the same method on identical test material, under the same conditions (same operator, same apparatus, same laboratory and a short period of time) may be expected to lie within a specified probability.

Reproducibility: the value below which the absolute difference between two single test results obtained using the same method on identical test material, under different conditions (different operators, different apparatus and/or different laboratories and/or different time) may be expected to lie within a specified probability.

The term "individual result" is the value obtained when the standardized trial method is applied, once and fully, to a single sample. Unless otherwise stated, the probability is 95%.

General Principles

- The method subjected to trial must be standardized, that is, chosen from the existing methods as the method best suited for subsequent general use.
- The protocol must be clear and precise.
- The number of laboratories participating must be at least ten.
- The samples used in the trials must be taken from homogeneous batches of material.
- The levels of the analyte to be determined must cover the concentrations generally encountered.
- Those taking part must have a good experience of the technique employed.
- For each participant, all analyses must be conducted within the same laboratory by the same analyst.
- The method must be followed as strictly as possible. Any departure from the method described must be documented.
- The experimental values must be determined under strictly identical conditions: on the same type of apparatus, etc.
- They must be determined independently of each other and immediately after each other.
- The results must be expressed by all laboratories in the same units, to the same number of decimal places.
- Five replicate experimental values must be determined, free from outliers. If an experimental value is an outlier according to the Grubbs test, three additional measurements must be taken.

Statistical Model

The statistical methods set out in this document are given for one level (concentration, sample). If there are a number of levels, the statistical evaluation must be made separately for each. If a linear relationship is found ($y = bx$ or $y = a + bx$) as between the repeatability (r) or reproducibility (R) and the concentration (\bar{x}), a regression of r (or R) may be run as a function of \bar{x}

The statistical methods given below suppose normally-distributed random values.

The steps to be followed are as follows:

- A/ Elimination of outliers within a single laboratory by Grubbs test. Outliers are values which depart so far from the other experimental values that these deviations cannot be regarded as random, assuming the causes of such deviations are not known.
- B/ Examine whether all laboratories are working to the same precision, by comparing variances by the Bartlett test and Cochran test. Eliminate those laboratories for which statistically deviant values are obtained.
- C/ Track down the systematic errors from the remaining laboratories by a variance analysis and by a Dixon test identify the extreme outlier values. Eliminate those laboratories for which the outlier values are significant.
- D/ From the remaining figures, calculate standard deviation of repeatability); S_r , and repeatability r standard deviation of reproducibility S_R and reproducibility R .

Notation:

The following designations have been chosen:

m	Number of laboratories
$i(i = 1, 2... m)$	Index (No. of the laboratory)
n_i	Number of individual values from the i th laboratory
$N = \sum_{i=1}^m n_i$	Total number of individual values
$x(i = 1, 2... n_i)$	Individual value of the i th laboratory
$\bar{x}_i = \frac{1}{n_i} \sum_{i=1}^{n_i} x_i$	Mean value of the i th laboratory
$\bar{x} = \frac{1}{N} \sum_{i=1}^m \sum_{i=1}^{n_i} x_i$	Total mean value
$s_i = \sqrt{\frac{1}{n_i-1} \sum_{i=1}^{n_i} (x_i - \bar{x}_i)^2}$	Standard deviation of the i th laboratory

A/ Verification of outlier values within one laboratory

After determining five individual values x_i , a Grubbs test is performed at the laboratory, to identify the outliers' values.

Test the null hypothesis whereby the experimental value with the greatest absolute deviation from the mean is not an outlier observation.

$$\text{Calculate PG} = \frac{|x_i^* - \bar{x}_i|}{s_i}$$

x_i^* = suspect value

Compare PG with the corresponding value shown in Table 1 for P = 95%.

If PG < value as read, value x_i^* is not an outlier and s_i can be calculated.

If PG > value as read, value x_i^* probably is an outlier therefore make a further three determinations.

Calculate the Grubbs test for x_i^* with the eight determinations.

If PG > corresponding value for P = 99%, regard x_i^* as a deviant value and calculate s_i without x_i^* .

**B/ Comparison of variances among laboratories
- Bartlett Test**

The Bartlett test allows us to examine both major and minor variances. It serves to test the null hypothesis of the equality of variances in all laboratories, as against the alternative hypothesis whereby the variances are not equal in the case of some laboratories.

At least five individual values are required per laboratory.

Calculate the statistics of the test:

$$PB = \frac{1}{C} \left[(N-m) \ln S_r^2 - \sum_{i=1}^m f_i \ln s_i^2 \right]$$

$$C = \frac{\sum_{i=1}^m \frac{1}{f_i} \frac{1}{N-m}}{3(m-1)} + 1$$

$$S_r^2 = \frac{\sum_{i=1}^m f_i s_i^2}{N-m}$$

$f_i = n_i - 1$ degrees of freedom of s_i .

Compare PB with the value x^2 indicated in table 2 at $m - 1$ degrees of freedom.

If $PB >$ the value in the table, there are differences among the variances.

The Cochran test is used to confirm that the variance from one laboratory is greater than that from other laboratories.

Calculate the test statistics:

$$PC = \frac{s_i^2 \max}{\sum_{i=1}^m s_i^2}$$

Compare PC with the value shown in table 3 for m and n_i at $P = 99\%$.

If $PC >$ the table value, the variance is significantly greater than the others.

If there is a significant result from the Bartlett or Cochran tests, eliminate the outlier variance and calculate the statistical test again.

In the absence of a statistical method appropriate to a simultaneous test of several outlier values, the repeated application of the tests is permitted, but should be used with caution.

If the laboratories produce variances that differ sharply from each other, an investigation must be made to find the causes and to decide whether the experimental values found by those laboratories are to be eliminated or not. If they are, the coordinator will have to consider how representative the remaining laboratories are.

If statistical analysis shows that there are differing variances, this shows that the laboratories have operated the methods at varying precisions. This may be due to inadequate practice or to lack of clarity or inadequate description in the method.

C/ Systematic errors

Systematic errors made by laboratories are identified using either Fischer's method or Dixon's test.

R .A. Fischer variance analysis

This test is applied to the remaining experimental values from the laboratories with an identical variance.

The test is used to identify whether the spread of the mean values from the laboratories is very much greater than that for the individual values expressed by the variance among the laboratories (s_z^2) or the variance within the laboratories (s_f^2).

Calculate the test statistics:

$$PF = \frac{s_z^2}{s_l^2}$$

$$s_z^2 = \frac{1}{m-1} \sum_{i=1}^m n_i (\bar{x}_i - \bar{x})^2$$

$$s_l^2 = \frac{1}{N-m} \sum_{i=1}^m \sum_{j=1}^{n_i} (x_{ij} - \bar{x}_i)^2$$

Compare PF with the corresponding value shown in table 4 (distribution of F) where $f_1 = f_z = m - 1$ and $f_2 = f_l = N - m$ degrees of freedom.

If $PF >$ the table value, it can be concluded that there are differences among the means, that is, there are systematic errors.

Dixon test

This test enables us to confirm that the mean from one laboratory is greater or smaller than that from the other laboratories.

Take a data series $Z(h)$, $h = 1, 2, 3, \dots, H$, ranged in increasing order.

Calculate the statistics for the test:

$$3 \text{ to } 7 \quad Q_{10} = \frac{Z(2) - Z(1)}{Z(H) - Z(1)} \quad \text{or} \quad \frac{Z(H) - Z(H-1)}{Z(H) - Z(1)}$$

$$8 \text{ to } 12 \quad Q_{11} = \frac{Z(2) - Z(1)}{Z(H-1) - Z(1)} \quad \text{or} \quad \frac{Z(H) - Z(H-1)}{Z(H) - Z(2)}$$

$$13 \text{ plus} \quad Q_{22} = \frac{Z(3) - Z(1)}{Z(H-2) - Z(1)} \quad \text{or} \quad \frac{Z(H) - Z(H-2)}{Z(H) - Z(3)}$$

Compare the greatest value of Q with the critical values shown in table 5.

If the test statistic is $>$ the table value at $P = 95\%$, the mean in question can be regarded as an outlier.

If there is a significant result in the R A Fischer variance analysis or the Dixon test, eliminate one of the extreme values and calculate the test statistics again with the remaining values. As regards repeated application of the tests, see the explanations in paragraph (B).

If the systematic errors are found, the corresponding experimental values concerned must not be included in subsequent computations; the cause of the systematic error must be investigated.

D/Calculating repeatability (*r*) and reproducibility (*R*).

From the results remaining after elimination of outliers, calculate the standard deviation of repeatability s_r and repeatability r , and the standard deviation of reproducibility s_R and reproducibility R , which are shown as characteristic values of the method of analysis.

$$s_r = \sqrt{\frac{1}{N-m} \sum_{i=1}^m f_i s_i^2} \qquad r = s_r \cdot 2\sqrt{2}$$

$$s_R = \sqrt{\frac{1}{a} [s_Z^2 + (a-1)s_f^2]} \qquad R = s_R \cdot 2\sqrt{2}$$

$$a = \frac{1}{m-1} \left[\left(N - \sum_{i=1}^m \frac{n_i^2}{N} \right) \right]$$

If there is no difference between the means from the laboratories, then there is no difference between s_r and s_R or between r and R . But, if we find differences among the laboratory means, although these may be tolerated for practical considerations, we have to show s_r and s_R , and r and R .

BIBLIOGRAPHY

- AFNOR, norme NFX06041, *Fidélité des méthodes d'essai. Détermination de la répétabilité et de la reproductibilité par essais interlaboratoires.*
- DAVIES O. L., GOLDSMITH P.I., *Statistical Methods in Research and Production*, Oliver and Boyd, Edinburgh, 1972.
- GOETSCH F. H., KRÖNERT W., OLSCHIMKE D., OTTO U., VIERKÖTTER S., *Meth. An.*, 1978, No 667.
- GOTTSCHALK G., KAISER K. E., *Einführung in die Varianzanalyse und Ringversuche*, B-1 Hoschultaschenbücher, Band 775, 1976.
- GRAF, HENNING, WILRICH, *Statistische Methoden bei textilen Untersuchungen*, Springer Verlag, Berlin, Heidelberg, New York, 1974.
- GRUBBS F. E., *Sample Criteria for Testing Outlying Observations*, The Annals of Mathematical Statistics, 1950, vol. 21, p 27-58.
- GRUBBS F. E., *Procedures for Detecting Outlying Observations in Samples*, Technometrics, 1969, vol. 11, No 1, p 1-21.
- GRUBBS F. E. and BECK G., *Extension of Sample Sizes and Percentage Points for Significance Tests of Outlying Observations*, Technometrics, 1972, vol. 14, No 4, p 847-854.
- ISO, norme 5725.
- KAISER R., GOTTSCHALK G., *Elementare Tests zur Beurteilung von Messdaten*, B-I Hochschultaschenbücher, Band 774, 1972.
- LIENERT G. A., *Verteilungsfreie Verfahren in der Biostatistik*, Band I, Verlag Anton Hain, Meisenheim am Glan, 1973.
- NALIMOV V. V., *The Application of Mathematical Statistics to Chemical Analysis*, Pergamon Press, Oxford, London, Paris, Frankfurt, 1963.
- SACHS L., *Statistische Auswertungsmethoden*, Springer Verlag, Berlin, Heidelberg, New York, 1968.

**COMPENDIUM OF INTERNATIONAL METHODS OF ANALYSIS–OIV
Collaborative Study**

Table 1 - Critical values for the Grubbs test

n_i	P = 95%	P 99%
3	1,155	1,155
4	1,481	1,496
5	<u>1,715</u>	1,764
6	1,887	1,973
7	2,020	2,139
8	2,126	<u>2,274</u>
9	2,215	2,387
10	2,290	2,482
11	2,355	2,564
12	2,412	2,636

Table 2 – Critical values for the Bartlett test (P = 95%)

$f(m - 1)$	χ^2	$f(m - 1)$	χ^2
1	3,84	21	32,7
2	5,99	22	33,9
3	7,81	23	35,2
4	9,49	24	36,4
5	11,07	25	37,7
6	12,59	26	38,9
7	14,07	27	40,1
8	15,51	28	41,3
9	16,92	29	42,6
10	18,31	30	43,8
11	19,68	35	49,8
12	21,03	40	55,8
13	22,36	50	67,5
14	23,69	60	79,1
15	25,00	70	90,5
16	26,30	80	101,9
17	27,59	90	113,1
18	28,87	100	124,3
19	30,14		
20	31,41		

**COMPENDIUM OF INTERNATIONAL METHODS OF ANALYSIS–OIV
Collaborative Study**

Table 3 – Critical values for the Cochran test

<i>m</i>	$n_i = 2$		$n_i = 3$		$n_i = 4$		$n_i = 5$		$n_i = 6$	
	99%	95%	99%	95%	99%	95%	99%	95%	99%	95%
2	-	-	0.995	0.975	0.979	0.939	0.959	0.906	0.937	0.877
3	0.993	0.967	0.942	0.871	0.883	0.798	0.834	0.746	0.793	0.707
4	0.968	0.906	0.864	0.768	0.781	0.684	0.721	0.629	0.676	0.590
5	0.928	0.841	0.788	0.684	0.696	0.598	0.633	0.544	0.588	0.506
6	0.883	0.781	0.722	0.616	0.626	0.532	0.564	0.480	0.520	0.445
7	0.838	0.727	0.664	0.561	0.568	0.480	0.508	0.431	0.466	0.397
8	0.794	0.680	0.615	0.516	0.521	0.438	0.463	0.391	0.423	0.360
9	0.754	0.638	0.573	0.478	0.481	0.403	0.425	0.358	0.387	0.329
10	0.718	0.602	0.536	0.445	0.447	0.373	0.393	0.331	0.357	0.303
11	0.684	0.570	0.504	0.417	0.418	0.348	0.366	0.308	0.332	0.281
12	0.653	0.541	0.475	0.392	0.392	0.326	0.343	0.288	0.310	0.262
13	0.624	0.515	0.450	0.371	0.369	0.307	0.322	0.271	0.291	0.246
14	0.599	0.492	0.427	0.352	0.349	0.291	0.304	0.255	0.274	0.232
15	0.575	0.471	0.407	0.335	0.332	0.276	0.288	0.242	0.259	0.220
16	0.553	0.452	0.388	0.319	0.316	0.262	0.274	0.230	0.246	0.208
17	0.532	0.434	0.372	0.305	0.301	0.250	0.261	0.219	0.234	0.198
18	0.514	0.418	0.356	0.293	0.288	0.240	0.249	0.209	0.223	0.189
19	0.496	0.403	0.343	0.281	0.276	0.230	0.238	0.200	0.214	0.181
20	0.480	0.389	0.330	0.270	0.265	0.220	0.229	0.192	0.205	0.174
21	0.465	0.377	0.318	0.261	0.255	0.212	0.220	0.185	0.197	0.167
22	0.450	0.365	0.307	0.252	0.246	0.204	0.212	0.178	0.189	0.160
23	0.437	0.354	0.297	0.243	0.238	0.197	0.204	0.172	0.182	0.155
24	0.425	0.343	0.287	0.235	0.230	0.191	0.197	0.166	0.176	0.149
25	0.413	0.334	0.278	0.228	0.222	0.185	0.190	0.160	0.170	0.144
26	0.402	0.325	0.270	0.221	0.215	0.179	0.184	0.155	0.164	0.140
27	0.391	0.316	0.262	0.215	0.209	0.173	0.179	0.150	0.159	0.135
28	0.382	0.308	0.255	0.209	0.202	0.168	0.173	0.146	0.154	0.131
29	0.372	0.300	0.248	0.203	0.196	0.164	0.168	0.142	0.150	0.127
30	0.363	0.293	0.241	0.198	0.191	0.159	0.164	0.138	0.145	0.124
31	0.355	0.286	0.235	0.193	0.186	0.155	0.159	0.134	0.141	0.120
32	0.347	0.280	0.229	0.188	0.181	0.151	0.155	0.131	0.138	0.117
33	0.339	0.273	0.224	0.184	0.177	0.147	0.151	0.127	0.134	0.114
34	0.332	0.267	0.218	0.179	0.172	0.144	0.147	0.124	0.131	0.111
35	0.325	0.262	0.213	0.175	0.168	0.140	0.144	0.121	0.127	0.108
36	0.318	0.256	0.208	0.172	0.165	0.137	0.140	0.119	0.124	0.106
37	0.312	0.251	0.204	0.168	0.161	0.134	0.137	0.116	0.121	0.103
38	0.306	0.246	0.200	0.164	0.157	0.131	0.134	0.113	0.119	0.101
39	0.300	0.242	0.196	0.161	0.154	0.129	0.131	0.111	0.116	0.099
40	0.294	0.237	0.192	0.158	0.151	0.126	0.128	0.108	0.114	0.097

**COMPENDIUM OF INTERNATIONAL METHODS OF ANALYSIS–OIV
Collaborative Study**

Table 4 – Critical values for the F-Test (P=99%)

f_1 f_2	1	2	3	4	5	6	7	8	9	10	11	12	13	14	15
1	4052	4999	5403	5625	5764	5859	5928	5981	6023	6056	6083	6106	6126	6143	6157
2	98.5	99.0	99.2	99.3	99.3	99.3	99.4	99.4	99.4	99.4	99.4	99.4	99.4	99.4	99.4
3	34.1	30.8	29.4	28.7	28.2	27.9	27.7	27.5	27.3	27.2	27.1	27.1	27.0	26.9	26.9
4	21.2	18.0	16.7	16.0	15.5	15.2	15.0	14.8	14.7	14.5	14.5	14.4	14.3	14.2	14.2
5	16.3	13.3	12.1	11.4	11.0	10.7	10.5	10.3	10.2	10.1	9.96	9.89	9.82	9.77	9.72
6	13.7	10.9	9.78	9.15	8.75	8.47	8.26	8.10	7.98	7.87	7.79	7.72	7.66	7.60	7.56
7	12.2	9.55	8.45	7.85	7.46	7.19	6.99	6.84	6.72	6.62	6.54	6.47	6.41	6.36	6.31
8	11.3	8.65	7.59	7.01	6.63	6.37	6.18	6.03	5.91	5.81	5.73	5.67	5.61	5.56	5.52
9	10.6	8.02	6.99	6.42	6.06	5.80	5.61	5.47	5.35	5.26	5.18	5.11	5.05	5.01	4.96
10	10.0	7.56	6.55	5.99	5.64	5.39	5.20	5.06	4.94	4.85	4.77	4.71	4.65	4.60	4.56
11	9.64	7.20	6.21	5.67	5.31	5.07	4.88	4.74	4.63	4.54	4.46	4.39	4.34	4.29	4.25
12	9.33	6.93	5.95	5.41	5.06	4.82	4.64	4.50	4.39	4.30	4.22	4.16	4.10	4.05	4.01
13	9.07	6.70	5.74	5.21	4.86	4.62	4.44	4.30	4.19	4.10	4.02	3.96	3.90	3.86	3.82
14	8.86	6.51	5.56	5.04	4.69	4.46	4.28	4.14	4.03	3.94	3.86	3.80	3.75	3.70	3.66
15	8.68	6.36	5.42	4.89	4.56	4.32	4.14	4.00	3.89	3.80	3.73	3.67	3.61	3.56	3.52
16	8.53	6.23	5.29	4.77	4.44	4.20	4.03	3.89	3.78	3.69	3.62	3.55	3.50	3.45	3.41
17	8.40	6.11	5.18	4.67	4.34	4.10	3.93	3.79	3.68	3.59	3.52	3.46	3.40	3.35	3.31
18	8.29	6.01	5.09	4.58	4.25	4.01	3.84	3.71	3.60	3.51	3.43	3.37	3.32	3.27	3.23
19	8.18	5.93	5.01	4.50	4.17	3.94	3.77	3.63	3.52	3.43	3.36	3.30	3.24	3.19	3.15
20	8.10	5.85	4.94	4.43	4.10	3.87	3.70	3.56	3.46	3.37	3.29	3.23	3.18	3.13	3.09
21	8.02	5.78	4.87	4.37	4.04	3.81	3.64	3.51	3.40	3.31	3.24	3.17	3.12	3.07	3.03
22	7.95	5.72	4.82	4.31	3.99	3.76	3.59	3.45	3.35	3.26	3.18	3.12	3.07	3.02	2.98
23	7.88	5.66	4.76	4.26	3.94	3.71	3.54	3.41	3.30	3.21	3.14	3.07	3.02	2.97	2.93
24	7.82	5.61	4.72	4.22	3.90	3.67	3.50	3.36	3.26	3.17	3.09	3.03	2.98	2.93	2.89
25	7.77	5.57	4.68	4.18	3.85	3.63	3.46	3.32	3.22	3.13	3.06	2.99	2.94	2.89	2.85
26	7.72	5.53	4.64	4.14	3.82	3.59	3.42	3.29	3.18	3.09	3.02	2.96	2.90	2.86	2.81
27	7.68	5.49	4.60	4.11	3.78	3.56	3.39	3.26	3.15	3.06	2.99	2.93	2.87	2.82	2.78
28	7.64	5.45	4.57	4.07	3.75	3.53	3.36	3.23	3.12	3.03	2.96	2.90	2.84	2.79	2.75
29	7.60	5.42	4.54	4.04	3.73	3.50	3.33	3.20	3.09	3.00	2.93	2.87	2.81	2.77	2.73
30	7.56	5.39	4.51	4.02	3.70	3.47	3.30	3.17	3.07	2.98	2.91	2.84	2.79	2.74	2.70
40	7.31	5.18	4.31	3.83	3.51	3.29	3.12	2.99	2.89	2.80	2.73	2.66	2.61	2.56	2.52
50	7.17	5.06	4.20	3.72	3.41	3.19	3.02	2.89	2.78	2.70	2.62	2.56	2.51	2.46	2.42
60	7.07	4.98	4.13	3.65	3.34	3.12	2.95	2.82	2.72	2.63	2.56	2.50	2.44	2.39	2.35
70	7.01	4.92	4.07	3.60	3.29	3.07	2.91	2.78	2.67	2.59	2.51	2.45	2.40	2.35	2.31
80	6.96	4.88	4.04	3.56	3.25	3.04	2.87	2.74	2.64	2.55	2.48	2.42	2.36	2.31	2.27
90	6.92	4.85	4.01	3.53	3.23	3.01	2.84	2.72	2.61	2.52	2.45	2.39	2.33	2.29	2.24
100	6.89	4.82	3.98	3.51	3.21	2.99	2.82	2.69	2.59	2.50	2.43	2.37	2.31	2.27	2.22
200	6.75	4.71	3.88	3.41	3.11	2.89	2.73	2.60	2.50	2.41	2.34	2.27	2.22	2.17	2.13
500	6.69	4.65	3.82	3.36	3.05	2.84	2.68	2.55	2.44	2.36	2.29	2.22	2.17	2.12	2.07
∞	6.63	4.61	3.78	3.32	3.02	2.80	2.64	2.51	2.41	2.32	2.25	2.18	2.13	2.08	2.04

**COMPENDIUM OF INTERNATIONAL METHODS OF ANALYSIS–OIV
Collaborative Study**

Table 4 – Critical values for the F-Test (P=99%) [Continued]

f_1 f_2	16	17	18	19	20	30	40	50	60	70	80	100	200	500	□
1	6169	6182	6192	6201	6209	6261	6287	6303	6313	6320	6326	6335	6350	6361	6366
2	99.4	99.4	99.4	99.4	99.5	99.5	99.5	99.5	99.5	99.5	99.5	99.5	99.3	99.5	99.5
3	26.8	26.8	26.8	26.7	26.7	26.5	26.4	26.4	26.3	26.3	26.3	26.2	26.2	26.1	26.1
4	14.2	14.1	14.1	14.0	14.0	13.8	13.7	13.7	13.7	13.6	13.6	13.6	13.5	13.5	13.5
5	9.68	9.64	9.61	9.58	9.55	9.38	9.29	9.24	9.20	9.18	9.16	9.13	9.08	9.04	9.02
6	7.52	7.48	7.45	7.42	7.40	7.23	7.14	7.09	7.06	7.03	7.01	6.99	6.93	6.90	6.88
7	6.28	6.24	6.21	6.18	6.16	5.99	5.91	5.86	5.82	5.80	5.78	5.75	5.70	5.67	5.65
8	5.48	5.44	5.41	5.38	5.36	5.20	5.12	5.07	5.03	5.01	4.99	4.96	4.91	4.88	4.86
9	4.92	4.89	4.86	4.83	4.81	4.65	4.57	4.52	4.48	4.46	4.44	4.41	4.36	4.33	4.31
10	4.52	4.49	4.46	4.43	4.41	4.25	4.17	4.12	4.08	4.06	4.04	4.01	3.96	3.93	3.91
11	4.21	4.18	4.15	4.12	4.10	3.94	3.86	3.81	3.77	3.75	3.73	3.70	3.65	3.62	3.60
12	3.97	3.94	3.91	3.88	3.86	3.70	3.62	3.57	3.54	3.51	3.49	3.47	3.41	3.38	3.36
13	3.78	3.74	3.72	3.69	3.66	3.51	3.42	3.37	3.34	3.32	3.30	3.27	3.22	3.19	3.17
14	3.62	3.59	3.56	3.53	3.51	3.35	3.27	3.22	3.18	3.16	3.14	3.11	3.06	3.03	3.00
15	3.49	3.45	3.42	3.40	3.37	3.21	3.13	3.08	3.05	3.02	3.00	2.98	2.92	2.89	2.87
16	3.37	3.34	3.31	3.28	3.26	3.10	3.02	2.97	2.93	2.91	2.89	2.86	2.81	2.78	2.75
17	3.27	3.24	3.21	3.19	3.16	3.00	2.92	2.87	2.83	2.81	2.79	2.76	2.71	2.68	2.65
18	3.19	3.16	3.13	3.10	3.08	2.92	2.84	2.78	2.75	2.72	2.70	2.68	2.62	2.59	2.57
19	3.12	3.08	3.05	3.03	3.00	2.84	2.76	2.71	2.67	2.65	2.63	2.60	2.55	2.51	2.49
20	3.05	3.02	2.99	2.96	2.94	2.78	2.69	2.64	2.61	2.58	2.56	2.54	2.48	2.44	2.42
21	2.99	2.96	2.93	2.90	2.88	2.72	2.64	2.58	2.55	2.52	2.50	2.48	2.42	2.38	2.36
22	2.94	2.91	2.88	2.85	2.83	2.67	2.58	2.53	2.50	2.47	2.45	2.42	2.36	2.33	2.31
23	2.89	2.86	2.83	2.80	2.78	2.62	2.54	2.48	2.45	2.42	2.40	2.37	2.32	2.28	2.26
24	2.85	2.82	2.79	2.76	2.74	2.58	2.49	2.44	2.40	2.38	2.36	2.33	2.27	2.24	2.21
25	2.81	2.78	2.75	2.72	2.70	2.54	2.45	2.40	2.36	2.34	2.32	2.29	2.23	2.19	2.17
26	2.78	2.75	2.72	2.69	2.66	2.50	2.42	2.36	2.33	2.30	2.28	2.25	2.19	2.16	2.13
27	2.75	2.71	2.68	2.66	2.63	2.47	2.38	2.33	2.29	2.27	2.25	2.22	2.16	2.12	2.10
28	2.72	2.68	2.65	2.63	2.60	2.44	2.35	2.30	2.26	2.24	2.22	2.19	2.13	2.09	2.06
29	2.69	2.66	2.63	2.60	2.57	2.41	2.33	2.27	2.23	2.21	2.19	2.16	2.10	2.06	2.03
30	2.66	2.63	2.60	2.57	2.55	2.39	2.30	2.25	2.21	2.18	2.16	2.13	2.07	2.03	2.01
40	2.48	2.45	2.42	2.39	2.37	2.20	2.11	2.06	2.02	1.99	1.97	1.94	1.87	1.85	1.80
50	2.38	2.35	2.32	2.29	2.27	2.10	2.01	1.95	1.91	1.88	1.86	1.82	1.76	1.71	1.68
60	2.31	2.28	2.25	2.22	2.20	2.03	1.94	1.88	1.84	1.81	1.78	1.75	1.68	1.63	1.60
70	2.27	2.23	2.20	2.18	2.15	1.98	1.89	1.83	1.78	1.75	1.73	1.70	1.62	1.57	1.54
80	2.23	2.20	2.17	2.14	2.12	1.94	1.85	1.79	1.75	1.71	1.69	1.65	1.58	1.53	1.49
90	2.21	2.17	2.14	2.11	2.09	1.92	1.82	1.76	1.72	1.68	1.66	1.62	1.55	1.50	1.46
100	2.19	2.15	2.12	2.09	2.07	1.89	1.80	1.74	1.69	1.66	1.63	1.60	1.52	1.47	1.43
200	2.09	2.06	2.03	2.00	1.97	1.79	1.69	1.63	1.58	1.55	1.52	1.48	1.39	1.33	1.28
500	2.04	2.00	1.97	1.94	1.92	1.74	1.63	1.56	1.52	1.48	1.45	1.41	1.31	1.23	1.16
□	2.00	1.97	1.93	1.90	1.88	1.70	1.59	1.52	1.47	1.43	1.40	1.36	1.25	1.15	1.00

Table 5 – Critical values for the Dixon test

Test criteria	<i>m</i>	Critical values	
		95%	99%
$Q_{10} = \frac{Z(2) - Z(1)}{Z(H) - Z(1)} \text{ ou } \frac{Z(H) - Z(H-1)}{Z(H) - Z(1)}$ The greater of the two values	3	0,970	0,994
	4	0,829	0,926
	5	0,710	0,821
	6	0,628	0,740
	7	0,569	0,680
$Q_{11} = \frac{Z(2) - Z(1)}{Z(H-1) - Z(1)} \text{ ou } \frac{Z(H) - Z(H-1)}{Z(H) - Z(2)}$ The greater of the two values	8	0,608	0,717
	9	0,564	0,672
	10	0,530	0,635
	11	0,502	0,605
	12	0,479	0,579
$Q_{22} = \frac{Z(3) - Z(1)}{Z(H-2) - Z(1)} \text{ ou } \frac{Z(H) - Z(H-2)}{Z(H) - Z(3)}$ The greater of the two values	13	0,611	0,697
	14	0,586	0,670
	15	0,565	0,647
	16	0,546	0,627
	17	0,529	0,610
	18	0,514	0,594
	19	0,501	0,580
	20	0,489	0,567
	21	0,478	0,555
	22	0,468	0,544
	23	0,459	0,535
	24	0,451	0,526
	25	0,443	0,517
	26	0,436	0,510
	27	0,429	0,502
	28	0,423	0,495
	29	0,417	0,489
	30	0,412	0,483
	31	0,407	0,477
	32	0,402	0,472
	33	0,397	0,467
	34	0,393	0,462
	35	0,388	0,458
	36	0,384	0,454
	37	0,381	0,450
	38	0,377	0,446
	39	0,374	0,442
	40	0,371	0,438

**COMPENDIUM OF INTERNATIONAL METHODS OF ANALYSIS–OIV
Collaborative Study**

Table 6 – Results of the collaborative study

Analysis										Sample				
Lab n°	Individual values x_I													
	1	2	3	4	5	6	7	8		n_1	x_1	s_1	s_1^2	
1	548	556	558	553	542					5	551	6,47	41,8	
2	300	299	304	308	300					5	302	3,83	14,7	$x_I < x$
3	567	558	563	532*	560	560	563	567		7	563	3,51	12,3	
4	557	550	555	560	551					5	555	4,16	17,3	
5	569	575	565	560	572					5	568	5,89	34,7	
6	550	546	549	557	588	570	576	568		8	563	14,92	222,6	$s_I > s_I$
7	557	560	560	552	547					5	555	5,63	31,7	
8	548	543	560	551	548					5	550	6,28	39,5	
9	558	563	551	555	560					5	556	5,63	31,7	
10	554	559	551	545	557					5	553	5,5	30,2	

Statistical Figures:

Bartlett Test:

Within laboratory: $s_1 = \pm 5.37$ $f_1 = 34$

$PB = 3.16 < 15.51$ (95%; $f = 8$)

Between laboratory: $s_z = \pm 13.97$ $fz = 7$

Analysis of variance:

$s_t = \pm 5.37$ $r = 15$ $s_R = \pm 7.78$ $R = 22$ $PF = 6.76 > 3.21$ (99%; $f_1 = 7$; $f_2 = 34$)

Reliability of analytical results

(Resolution Oeno 5/99)

Data concerning the reliability of analytical methods, as determined by collaborative studies, are applicable in the following cases:

- 1) Verifying the results obtained by a laboratory with a reference method
- 2) Evaluating analytical results which indicate a legal limit has been exceeded
- 3) Comparing results obtained by two or more laboratories and comparing those results with a reference value
- 4) Evaluating results obtained from a non-validated method

1) VERIFICATION OF THE ACCEPTABILITY OF RESULTS OBTAINED WITH A REFERENCE METHOD

The validity of analytical results depends on the following:

- the laboratory should perform all analyses within the framework of an appropriate quality control system which includes the organization, responsibilities, procedures, etc.
- as part of the quality control system, the laboratory should operate according to an internal Quality Control Procedure
- results should be obtained in accordance with the acceptability criteria described in the internal Quality Control Procedure

Internal quality control shall be established in accordance with internationally recognized standards, such those of the IUPAC document titled, "Harmonized Guidelines for Internal Quality Control in Analytical Laboratories."

Internal Quality Control implies an analysis of the reference material.

Reference samples should consist of a template of the samples to be analyzed and should contain an appropriate, known concentration of the substance analyzed which is similar to that found in the sample.

To the extent possible, reference material shall be certified by an internationally recognized organization.

However, for many types of analysis, there are no certified reference materials. In this case, one could use, for example, material analyzed by several laboratories in a competence test and considering the average of the results to be the value assigned to the substance analyzed.

One could also prepare reference material by formulation (model solution with known components) or by adding a known quantity of the substance analyzed to a

sample which does not contain (or not yet contain) the substance by means of a recovery test (dosed addition) on one of the samples to analyze.

Quality Control is assured by adding reference material to each series of samples, and analyzing these pairs (test samples and reference material). This verifies correct implementation of the method and should be independent of the analytical calibration and protocol as its goal is to verify the aforementioned.

Series means a number of samples analyzed under repeatable conditions. Internal controls serve to ensure the appropriate level of uncertainty is not exceeded.

If the analytical results are considered to be part of a normal population whose mean is m and standard deviation is s , only around 0.3% of the results will be outside the limits $m \pm 3s$. When aberrant results are obtained (outside these limits), the system is considered to be outside statistical control (unreliable data).

The control is graphically represented using Shewhart Control Graphs. To produce these graphical results, the measured values obtained from the reference material are placed on the vertical axis while the series numbers are placed on the horizontal axis. The graph also includes horizontal lines representing the mean, m , $m \pm 2$ (warning limits) and $m \pm 3$ (action limits) (Figure 1).

To estimate the standard deviation, a control should be analyzed, in pairs, in at least 12 trials. Each analytical pair shall be analyzed under repeatable conditions and randomly inserted in a sample series. Analyses will be duplicated on different days to reflect reasonable changes from one series to another. Variations can have several causes: modification of the reactants composition, instrument re-calibration and even different operators. After eliminating aberrant data using the Grubbs test, calculate the standard deviation to construct the Shewhart graphs. This standard deviation is compared to that of the reference method. If a published precision level is not obtained for the reference method, caused should be investigated.

The precision limits of the laboratory should be periodically revised by repeating the indicated procedure.

Once the Quality Control graph is constructed, graph the results obtained from each series for the control material.

A series is considered outside statistical control if:

- I) a value is outside the action limit,
- II) the current and previous values are situated outside the attention limits even in within the action limits,
- III) nine successive values lie on the same side of the mean.

The laboratory response to "outside control" conditions is to reject the results for the series and perform tests to determine the cause, then take action to remedy the situation.

A Shewhart Control Graph can also be produced for the differences between analytical pairs in the same sample, especially when reference material does not exist. In this case, the absolute difference between two analyses of the same sample is graphed. The graph's lower line is 0 and the attention limit is $1.128S_w$ while the action limit is $3.686S_w$ where S_w = the standard deviation of a series.

This type of graph only accounts for repeatability. It should be no greater than the published repeatability limit for the method.

In the absence of control material, it sometimes becomes necessary to verify that the reproducibility limit of the reference method is not exceeded by comparing the results obtained to those of obtained by an experimental laboratory using the same sample.

Each laboratory performs two tests and the following formula is used:

$$C_r D_{95}(\bar{y}_1 - \bar{y}_2) = \sqrt[2]{R^2 - \frac{r^2}{2}}$$

$C_r D_{95}$	=	Critical difference (P=0,95)
\bar{y}_1	=	Means of 2 results obtained by lab 1
\bar{y}_2	=	Means of 2 results obtained by lab 2
R	=	Reproducibility of reference method
r	=	Repeatability of reference method

If the critical difference has been exceeded, the underlying reason is to be found and the test is to be repeated within one month.

2) EVALUATION OF ANALYTIC RESULTS INDICATING THAT A LEGAL LIMIT HAS BEEN EXCEEDED.

When analytical results indicated that a legal limit has been exceeded, the following procedure should be followed:

- 1) In the case of an individual result, conduct a second test under repeatable conditions. If it is not possible to conduct a second test under repeatable conditions, conduct a double analysis under repeatable conditions and use these data to evaluate the critical difference.
- 2) Determine the absolute value of the difference between the mean of the results obtained under repeatable conditions and the legal limit. An absolute value of the difference which is greater than the critical distance indicates that the sample does not fit the specifications.

Critical difference is calculated by the formula:

$$C_r D_{95}(\bar{y} - m_0) = \frac{1}{\sqrt[2]{2}} \sqrt{R^2 - r^2 \frac{n-1}{n}}$$

\bar{y}	=	Mean of results obtained
m_0	=	Limit
n	=	Number of analyses
R	=	reproducibility
r	=	repeatability

In other words, this is a maximal limit where the average of the results obtained should not be greater than:

$$m_0 + C_r D_{95}(y - m_0)$$

If the limit is a minimum, the average of the results obtained should not be less than:

$$m_0 - C_r D_{95}(y - m_0)$$

3) COMPARING RESULTS OBTAINED USING TWO OR MORE LABORATORIES AND COMPARING THESE RESULTS TO A REFERENCE VALUE

To determine whether or not data originating in two laboratories are in agreement, calculate the absolute difference between the two results and compare to the critical difference:

$$C_r D_{95}(\bar{y}_1 - \bar{y}_2) = \sqrt[3]{R^2 - r^2 \left(1 - \frac{1}{2n_1} - \frac{1}{2n_2}\right)}$$

\bar{y}_1	=	Mean of 2 results obtained by lab 1
\bar{y}_2	=	Mean of 2 results obtained by lab 2
n_1	=	number of analyses in lab 1 sample
n_2	=	number of analyses in lab 2 sample
R	=	Reproducibility of reference method
r	=	Repeatability of reference method

If the result is the average of two tests, the equation can be simplified to:

$$C_r D_{95}(\bar{y}_1 - \bar{y}_2) = \sqrt[3]{R^2 - \frac{r^2}{2}}$$

If the data are individual results, the critical difference is R.

If the critical difference is not exceeded, the conclusion is that the results of the two laboratories are in agreement.

Comparing results obtained by several laboratories with a reference value:

Suppose p laboratories have made n₁ determinations, whose mean for each laboratory is \bar{y}_1 and whose total mean is:

$$\bar{y} = \frac{1}{p} \sum \bar{y}_i$$

The mean of all laboratories is compared with the reference value. If the absolute difference exceeds the critical difference, as calculated using the following formula, we conclude the results are not in agreement with the reference value:

$$C_r D_{95}(\bar{y} - m_0) = \frac{1}{\sqrt[3]{2p}} \sqrt[3]{R^2 - r^2 \left(1 - \frac{1}{p} \sum \frac{1}{n_i}\right)}$$

$C_r D_{95}$ = Critical difference, calculated as indicated in point 2, for the reference method.

For example, the reference value can be the value assigned to a reference material or the value obtained by the same laboratory or by a different laboratory with a different method.

4) EVALUATING ANALYTICAL RESULTS OBTAINED USING NON-VALIDATED METHODS

A provisional reproducibility value can be assigned to a non-validated method by comparing it to that of a second laboratory:

$$R_{prov} = \sqrt[3]{(\bar{y}_1 - \bar{y}_2)^2 + \frac{r^2}{2}}$$

\bar{y}_1 = Mean of 2 results obtained by lab 1
 \bar{y}_2 = Mean of 2 results obtained by lab 2
 r = Repeatability of reference method

Provisional reproducibility can be used to calculate critical difference.

If provisional reproducibility is less than twice the value of repeatability, it should be set to $2r$.

A reproducibility value greater than three times repeatability or twice the value calculated using the Horwitz equation is not acceptable.

Horwitz equation:

$$RSD_R \% = 2^{1-0,5 \log_{10} C}$$

RSD_R % = Standard deviation for reproducibility
(expressed as a percentage of the mean)

C = concentration, expressed as a decimal fraction (for example, 10g/100g = 0.1)

This equation was empirically obtained from more than 3000 collaborative studies including a diverse group of analyzed substances, matrices and measurement techniques. In the absence of other information, RSD_R values that are lower or equal to the RSD_R values calculated using the Horwitz equation can be considered acceptable.

RSD_R values calculated by the Horwitz equation:

Concentration	RSD _R %
10 ⁻⁹	45
10 ⁻⁸	32
10 ⁻⁷	23
10 ⁻⁶	16
10 ⁻⁵	11
10 ⁻⁴	8
10 ⁻³	5,6
10 ⁻²	4
10 ⁻¹	2,8
1	2

If the result obtained using a non-validated method is close to the limit specified by legislation, the decision on the limit shall be decided as follows (for upper limits):

$$S = m_0 + \{(R_{\text{rout}}/R_{\text{ref}})-1\} \times C_r D_{95}$$

and, for lower limits,

$$S = m_0 - \{(R_{\text{rout}}/R_{\text{ref}})-1\} \times C_r D_{95}$$

S = decision limit

m₀ = legal limit

R_{rout} = provisional reproducibility for non-validated method

R_{ref} = reproducibility for reference method

C_rD₉₅ = critical difference, calculated as indicated in point 2, for the reference method

The result which exceeds the decision limit should be replaced with a final result obtained using the reference method.

Critical differences for probability levels other than 95%

COMPENDIUM OF INTERNATIONAL METHODS OF ANALYSIS- OIV
Reliability of Analytical Methods

This difference can be determined by multiplying the critical differences at the 95% level by the coefficients shown in Table 1.

Table 1 - Multiplicative coefficients allowing
the calculation of critical differences for
probability levels other than 95%

Probability level P	Multiplicative coefficient
90	0,82
95	1,00
98	1,16
99	1,29
99,5	1,40

SHEWHART CONTROL GRAPH

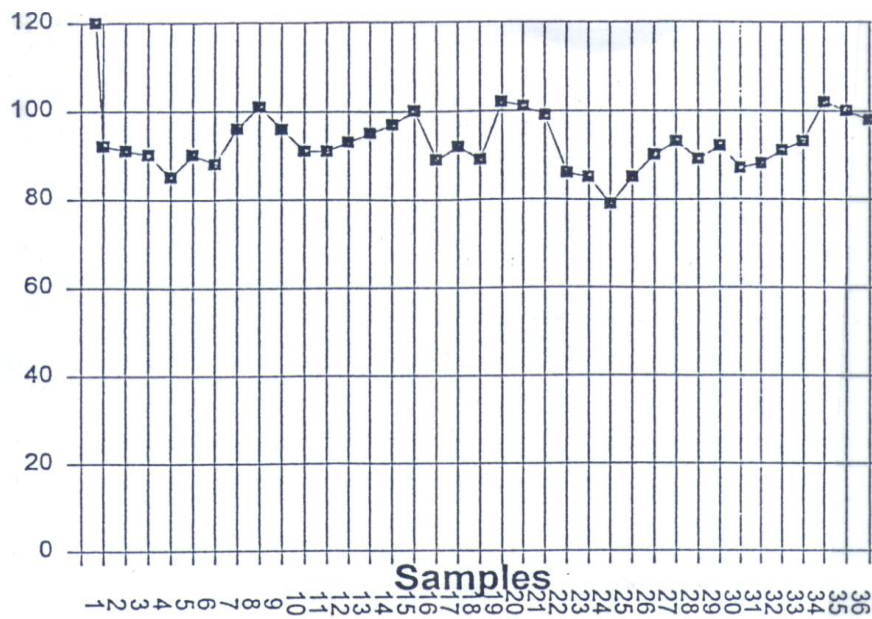

BIBLIOGRAPHY

- "Harmonized Guidelines for Internal Quality Control in Analytical Chemistry Laboratories". IUPAC. Pure and App. Chem. Vol 67, n° 4, 649-666, 1995
- "Shewhart Control Charts" ISO 8258. 1991.
- "Precision of test methods - Determination of repeatability and reproducibility for a standard test method by inter-laboratory tests". ISO 5725, 1994.
- "Draft Commission Regulation of establishing rules for the application of reference and routine methods for the analysis and quality evaluation of milk and milk products". Commission of the European Communities, 1995.
- "Harmonized protocols for the adoption of standardized analytical methods and for the presentation of their performance characteristics". IUPAC. Pure and App. Chem., Vol. 62, n° 1, 149-162. 1990.

**Protocol for the design, conducts and interpretation of
collaborative studies**
(Resolution Oeno 6/2000)

INTRODUCTION

After a number of meetings and workshops, a group of representatives from 27 organizations adopted by consensus a "Protocol for the design, conducts and interpretation of collaborative studies" which was published in Pure & Appl. Chem. 60, 855-864, 1995. A number of organizations have accepted and used this protocol. As a result of their experience and the recommendations of the Codex Committee on Methods of Analysis and Sampling (Joint FAO/WHO Food Standards Programme, Report of the Eighteenth Session, 9-13 November, 1992; FAO, Rome Italy, ALINORM 93/23, Sections 34-39), three minor revisions were recommended for incorporation into the original protocol. These are: (1) Delete the double split level design because the interaction term it generates depends upon the choice of levels and if it is statistically significant, the interaction cannot be physically interpreted. (2) Amplify the definition of "material". (3) Change the outlier removal criterion from 1% to 2.5%.

The revised protocol incorporating the changes is reproduced below. Some minor editorial revisions to improve readability have also been made. The vocabulary and definitions of the document 'Nomenclature of Interlaboratory Studies (Recommendations 1994)' [published in Pure Appl Chem., 66, 1903-1911 (1994)] has been incorporated into this revision, as well as utilizing, as far as possible, the appropriate terms of the International Organization for Standardization (ISO), modified to be applicable to analytical chemistry.

PROTOCOL

1 Preliminary work

Method-performance (collaborative) studies require considerable effort and should be conducted only on methods that have received adequate prior testing. Such within-laboratory testing should include, as applicable, information on the following:

1.1 Preliminary estimates of precision

Estimates of the total within-laboratory standard deviation of the analytical results over the concentration range of interest as a minimum at the upper and lower limits

of the concentration range, with particular emphasis on any standard or specification value.

NOTE 1: The total within-laboratory standard deviation is a more inclusive measure of imprecision than the ISO repeatability standard deviation, §3.3 below. This standard deviation is the largest of the within-laboratory type precision variables to be expected from the performance of a method; it includes at least variability from different days and preferably from different calibration curves. It includes between-run (between-batch) as well as within-run (within-batch) variations. In this respect it can be considered as a measure of within-laboratory reproducibility. Unless this value is well within acceptable limits, it cannot be expected that the between-laboratory standard deviation (reproducibility standard deviation) will be any better. This precision term is not estimated from the minimum study described in this protocol.

NOTE 2: The total within-laboratory standard deviation may also be estimated from ruggedness trials that indicate how tightly controlled the experimental factors must be and what their permissible ranges are. These experimentally determined ranges should be incorporated into the description of the method.

1.2 Systematic error (bias)

Estimates of the systematic error of the analytical results over the concentration range and in the substances of interest, as a minimum at the upper and lower limits of the concentration range, with particular emphasis on any standard or specification value.

The results obtained by applying the method to relevant reference materials should be noted.

1.3 Recoveries

The recoveries of "spikes" added to real materials and to extracts, digests, or other treated solutions thereof.

1.4 Applicability

The ability of the method to identify and measure the physical and chemical forms of the analyte likely to be present in the materials, with due regard to matrix effects.

1.5 Interference

The effect of other constituents that are likely to be present at appreciable concentrations in matrices of interest and which may interfere in the determination.

1.6 Method comparison

The results of comparison of the application of the method with existing tested methods intended for similar purposes.

1.7 Calibration Procedures

The procedures specified for calibration and for blank correction must not introduce important bias into the results.

1.8 Method description

The method must be clearly and unambiguously written.

1.9 Significant figures

The initiating laboratory should indicate the number of significant figures to be reported, based on the output of the measuring instrument.

NOTE: In making statistical calculations from the reported data, the full power of the calculator or computer is to be used with no rounding or truncating until the final reported mean and standard deviations are achieved. At this point the standard deviations are rounded to 2 significant figures and the means and related standard deviations are rounded to accommodate the significant figures of the standard deviation. For example, if $S_R = 0.012$, c is reported as 0.147, not as 0.1473 or 0.15, and RSD_R is reported as 8.2%. (Symbols are defined in Appendix L) If standard deviation calculations must be conducted manually in steps, with the transfer of intermediate results, the number of significant figures to be retained for squared numbers should be at least 2 times the number of figures in the data plus 1.

2. Design of the method-performance study

2.1 Number of materials

For a single type of substance, at least 5 materials (test samples) must be used; only when a single level specification is involved for a single matrix may this minimum required number of materials to be reduced to 3. For this design parameter, the two portions of a split level and the two individual portions of blind replicates per laboratory are considered as a single material.

NOTE 1: A material is an 'analyte/matrix/concentration' combination to which the method-performance parameters apply. This parameter determines the applicability of a method. For application to a number of different substances, a sufficient

number of matrices and levels should be chosen to include potential interferences and the concentration of typical use.

NOTE 2: The 2 or more test samples of blind or open replicates statistically, are a single material (they are not independent).

NOTE 3: A single split level (Youden pair) statistically analyzed as a pair is a single material; if analyzed statistically and reported as single test samples, they are 2 materials. In addition, the pair can be used to calculate the within-laboratory standard deviation, s_r as

$$s_r = \sqrt{(\sum d_i^2) / 2n} \quad (\text{for duplicates, blind or open}),$$

$$s_r = \sqrt{(\sum (d_i^2) / 2(n - 1))} \quad (\text{for Youden pairs}),$$

where d_i , the difference between the 2 individual values from the split level for each laboratory and n is the number of laboratories. In this special case, S_R , the among laboratories standard deviation, is merely the average of the two S_R values calculated from the individual components of the split level, and it is used only as a check of the calculations.

NOTE 4: The blank or negative control may be a material or not depending on the usual purpose of the analysis. For example, in trace analysis, where very low levels (near the limit of quantitation) are often sought, the blanks are considered as materials and are necessary to determine certain 'limits of measurement.' However, if the blank is merely a procedural control in macro analysis (e.g., fat in cheese), it would not be considered a material.

2.2 Number of laboratories

At least 8 laboratories must report results for each material; only when it is impossible to obtain this number (e.g., very expensive instrumentation or specialized laboratories required) may the study be conducted with less, but with an absolute minimum of 5 laboratories. If the study is intended for international use, laboratories from different countries should participate. In the case of methods requiring the use of specialized instruments, the study might include the entire population of available laboratories. In such cases, "n" is used in the denominator for calculating the standard deviation instead of "(n - 1)". Subsequent entrants to the field should demonstrate the ability to perform as well as the original participant.

2.3 Number of Replicates

The repeatability precision parameters must be estimated by using one of the following sets of designs (listed in approximate order of desirability):

2.3.1 Split Level

For each level that is split and which constitutes only a single material for purposes of design and statistical analysis, use 2 nearly identical test samples that differ only slightly in analyte concentration (e.g., <1-5%). Each laboratory must analyse each test sample once and only once.

NOTE: The statistical criterion that must be met for a pair of test samples to constitute a split level is that the reproducibility standard deviation of the two parts of the single split level must be equal.

2.3.2 Combination blind replicates and split level

Use split levels for some materials and blind replicates for other materials in the same study (single values from each submitted test sample).

2.3.3 Blind replicates

For each material, use blind identical replicates, when data censoring is impossible (e.g., automatic input, calculation, and printout) non-blind identical replicates may be used.

2.3.4 Known replicates

For each material, use known replicates (2 or more analyses of test portions from the same test sample), but only when it is not practical to use one of the preceding designs.

2.3.5 Independent analyses

Use only a single test portion from each material (i.e., do not perform multiple analyses) in the study, but rectify the inability to calculate repeatability parameters by quality control parameters or other within-laboratory data obtained independently of the method-performance study.

3. Statistical analysis (See Flowchart, A.4. 1)

For the statistical analysis of the data, the required statistical procedures listed below must be performed and the results reported. Supplemental, additional procedures are not precluded.

3.1 Valid data

Only valid data should be reported and subjected to statistical treatment. Valid data are those data that would be reported as resulting from the normal performance of laboratory analyses; they are not marred by method deviations, instrument malfunctions, unexpected occurrences during performance, or by clerical, typographical and arithmetical errors.

3.2 One-way analysis of variance

One-way analysis of variance and outlier treatments must be applied separately to each material (test sample) to estimate the components of variance and repeatability and reproducibility parameters.

3.3 Initial estimation

Calculate the mean, \bar{c} (= the average of laboratory averages), repeatability relative standard deviation, RSD_r , and reproducibility relative standard deviation, RSD_R with no outliers removed, but using only valid data.

3.4 Outlier treatment

The estimated precision parameters that must also be reported are based on the initial valid data purged of all outliers flagged by the harmonized 1994 outlier removal procedure. This procedure essentially consists of sequential application of the Cochran and Grubbs tests (at 2.5% probability (P) level, 1-tail for Cochran and 2-tail for Grubbs) until no further outliers are flagged or until a drop of 22.2% (= 2/9) in the original number of laboratories providing valid data would occur.

NOTE: Prompt consultation with a laboratory reporting suspect values may result in correction of mistakes or discovering conditions that lead to invalid data, 3.1. Recognizing mistakes and invalid data per se is much preferred to relying upon statistical tests to remove deviate values.

3.4.1 Cochran test

First apply Cochran outlier test (1-tail test a $P = 2.5\%$) and remove any laboratory whose critical value exceeds the tabular value given in the table, Appendix A.3. 1, for the number of laboratories and replicates involved.

3.4.2 Grubbs tests

Apply the single value Grubbs test (2 tail) and remove any outlying laboratory. If no laboratory is flagged, then apply the pair value tests (2 tail) - - 2 at the same end and 1 value at each end, $P = 2.5\%$ overall. Remove any laboratory(ies) flagged by these tests whose critical value exceeds the tabular value given in the appropriate column of the table Appendix A.3.3. Stop removal when the next application of the test will flag as table, A outliers more than 22.2% (2 of 9) of the laboratories.

NOTE: The Grubbs tests are to be applied one material at a time to the set of replicate means from all laboratories, and not to the individual values from replicated designs because the distribution of all the values taken together is multimodal, not Gaussian, i.e., their differences from the overall mean for that material are not independent.

3.4.3 Final estimation

Recalculate the parameters as in §3.3 after the laboratories flagged by the preceding procedure have been removed. If no outliers were removed by the Cochran-Grubbs sequence, terminate testing. Otherwise, reapply the Cochran-Grubbs sequence to the data purged of the flagged outliers until no further outliers are flagged or until more than a total of 22.2% (2 of 9 laboratories) would be removed in the next cycle. See flowchart A.3.4.

4. Final report

The final report should be published and should include all valid data. Other information and parameters should be reported in a format similar (with respect to the reported items) to the following, as applicable:

[x] Method-performance tests carried out at the international level in [year(s)] by [organisation] in which [y and z] laboratories participated, each performing [k] replicates, gave the following statistical results:

TABLE OF METHOD-PERFORMANCE PARAMETERS

Analyte; Results expressed in [units]

Material [Description and listed in columns across top of table in increasing order of magnitude of means]

Number of laboratories retained after eliminating outliers

Number of outlying laboratories

Code (or designation) of outlying laboratories

Number of accepted results

Mean

True or accepted value, if known

Repeatability standard deviation (S_r)

Repeatability relative standard deviation (RSD_R)

Repeatability limit, r ($2.8 \times S_r$)

Reproducibility standard deviation (S_R)

Reproducibility relative standard deviation (RSD_R)

Reproducibility limit, R ($2.8 \times S_R$)

4.1 Symbols

A set of symbols for use in reports and publications is attached as Appendix 1 (A.1.).

4.2 Definitions

A set of definitions for use in study reports and publications is attached as Appendix 2 (A.2.).

4.3 Miscellaneous

4.3.1 Recovery

Recovery of added analyte as a control on method or laboratory bias should be calculated as follows:

[Marginal] Recovery, % =

$(\text{Total analyte found} - \text{analyte originally present}) \times 100 / (\text{analyte added})$

Although the analyte may be expressed as either concentration or amount, the units must be the same throughout. When the quantity of analyte is determined by analysis, it must be determined in the same way throughout.

Analytical results should be reported uncorrected for recovery. Report recoveries separately.

4.3.2 When S_r is negative

By definition, S_R is greater than or equal to S_r in method-performance studies; occasionally the estimate of S_r is greater than the estimate of S_R (the average of the replicates is greater than the range of laboratory averages and the calculated S_L^2 is then negative). When this occurs, set $S_L = 0$ and $S_R = S_r$.

5. REFERENCES

Horwitz, W. (1988) Protocol for the design, conduct, and interpretation of method performance studies. *Pure & Appl. Chem.* 60, 855-864.

Pocklington, W.D. (1990) Harmonized protocol for the adoption of standardized analytical methods and for the presentation of their performance characteristics. *Pure and Appl. Chem.* 62, 149-162.

International Organization for Standardization. International Standard 5725-1986. Under revision in 6 parts; individual parts may be available from National Standards member bodies.

A. APPENDICES

APPENDIX 1. - SYMBOLS

Use the following set of symbols and terms for designating parameters developed by a method-performance study.

Mean (of laboratory averages)	\bar{x}
Standard deviations:	s (estimates)
Repeatability	S_r
'Pure' between-laboratory	S_L
Reproducibility	S_R
Variances:	S^2 (with subscripts, r, L, and R)
$S_R^2 = S_L^2 + S_r^2$	
Relative standard deviations:	RSD (with subscripts, r, L, and r)
Maximum tolerable differences (as defined by ISO 5725-1986); See A.2.4 and A.2.5)	
Repeatability limit	$r = (2.8 \times S_r)$
Reproducibility limit	$R = (2.8 \times S_R)$
Number of replicates per laboratory	k (general)
Average number of replicates per laboratory i	k (for a balanced design)
Number of laboratories	L
Number of materials (test samples)	m
Total number of values in a given assay n (= kL for a balanced design)	
Total number of values in a given study N (= kLm for an overall balanced design)	

If other symbols are used, their relationship to the recommended symbols should be explained fully.

APPENDIX 2. - DEFINITIONS

Use the following definitions. The first three definitions utilize the IUPAC document "Nomenclature of Interlaboratory Studies" (approved for publication 1994). The next two definitions are assembled from components given in ISO 3534-1:1993. All test results are assumed to be independent, i.e., 'obtained in a manner not influenced by any previous result on the same or similar test object. Quantitative measures of precision depend critically on the stipulated conditions. Repeatability and reproducibility conditions are particular sets of extreme stipulated conditions.'

A.2.1 Method-performance studies

An interlaboratory study in which all laboratories follow the same written protocol and use the same test method to measure a quantity in sets of identical test items [test samples, materials]. The reported results are used to estimate the performance characteristics of the method. Usually these characteristics are within-laboratory and among-laboratories precision, and when necessary and possible, other pertinent characteristics such as systematic error, recovery, internal quality control parameters, sensitivity, limit of determination, and applicability.

A.2.2. Laboratory-performance study

An interlaboratory study that consists of one or more analyses or measurements by a group of laboratories on one or more homogeneous, stable test items, by the method selected or used by each laboratory. The reported results are compared with those of other laboratories or with the known or assigned reference value, usually with the objective of evaluating or improving laboratory performance.

A.2.3 Material certification stud

An interlaboratory study that assigns a reference value ('true value') to a quantity (concentration or property) in the test item, usually with a stated uncertainty.

A.2.4 Repeatability limit (r)

When the mean of the values obtained from two single determinations with the same method on identical test items in the same laboratory by the same operator using the same equipment within short intervals of time, lies within the range of the mean values cited in the Final Report, 4.0, the absolute difference between the two test results obtained should be less than or equal to the repeatability limit (r) [= 2.8 x s_r) that can generally be inferred by linear interpolation of s_r from the Report.

NOTE: This definition, and the corresponding definition for reproducibility limit, has been assembled from five cascading terms and expanded to permit application by interpolation to a test item whose mean is not the same as that used to establish the original parameters, which is the usual case in applying these definitions. The term 'repeatability [and reproducibility] limit' is applied specifically to a probability

of 95% and is taken as $2.8 \times s$, [or SRI. The general term for this statistical concept applied to any measure of location (e.g., median) and with other probabilities (e.g., 99%) is "repeatability [and reproducibility] critical difference".

A.2.5 Reproducibility limit (R)

When the mean of the values obtained from two single determinations with the same method on identical test items in different laboratories with different operators using different equipment, lies within the range of the mean values cited in the Final Report, 4.0, the absolute difference between the two test results obtained should be less than or equal to the reproducibility limit (R) [= $2.8 \times S_R$] that can generally be inferred by linear interpolation of S_R from the Report.

NOTE 1: When the results of the interlaboratory test make it possible, the value of r and R can be indicated as a relative value (e.g., as a percentage of the determined mean value) as an alternative to the absolute value.

NOTE 2: When the final reported result in the study is an average derived from more than a single value, i.e., k is greater than 1, the value for R must be adjusted according to the following formula before using R to compare the results of a single routine analyses between two laboratories.

$$R' = (R^2 + r^2 (1 - [1/k])^{1/2})$$

Similar adjustments must be made for replicate results constituting the final values for S_R and RSD_R , if these will be the reported parameters used for quality control purposes.

NOTE 3: The repeatability limit, r , may be interpreted as the amount within which two determinations should agree with each other within a laboratory 95% of the time. The reproducibility limit, R , may be interpreted as the amount within which two separate determinations conducted in different laboratories should agree with each other 95% of the time.

NOTE 4: Estimates Of S_R can be obtained only from a planned, organized method performance study; estimates of S_r can be obtained from routine work within a laboratory by use of control charts. For occasional analyses, in the absence of control charts, within-laboratory precision may be approximated as one half S_R (Pure and Appl. Chem., 62, 149-162 (1990) , Sec. L3, Note.).

A.2.6 One-way analysis of variance

One-way analysis of variance is the statistical procedure for obtaining the estimates of within laboratory and between-laboratory variability on a material-by-material basis. Examples of the calculations for the single level and single-split-level designs can be found in ISO 5725-1986.

APPENDIX 3. - CRITICAL VALUES

A.3.1 Critical values for the Cochran maximum variance ratio at the 2.5% (1 -tail) rejection level, expressed as the percentage the highest variance is of the total variance; r = number of replicates.

No. of Labs	r=2	r = 3	r=4	r = 5	r = 6
4	94.3	81.0	72.5	65.4	62.5
5	88.6	72.6	64.6	58.1	53.9
6	83.2	65.8	58.3	52.2	47.3
7	78.2	60.2	52.2	47.3	42.3
8	73.6	55.6	47.4	43.0	38.5
9	69.3	51.8	43.3	39.3	35.3
10	65.5	48.6	39.9	36.2	32.6
11	62.2	45.8	37.2	33.6	30.3
12	59.2	43.1	35.0	31.3	28.3
13	56.4	40.5	33.2	29.2	26.5
14	53.8	38.3	31.5	27.3	25.0
15	51.5	36.4	29.9	25.7	23.7
16	49.5	34.7	28.4	24.4	22.0
17	47.8	33.2	27.1	23.3	21.2
18	46.0	31.8	25.9	22.4	20.4
19	44.3	30.5	24.8	21.5	19.5
20	42.8	29.3	23.8	20.7	18.7
21	41.5	28.2	22.9	19.9	18.0
22	40.3	27.2	22.0	19.2	17.3
23	39.1	26.3	21.2	18.5	16.6
24	37.9	25.5	20.5	17.8	16.0
25	36.7	24.8	19.9	17.2	15.5
26	35.5	24.1	19.3	16.6	15.0
27	34.5	23.4	18.7	16.1	14.5
28	33.7	22.7	18.1	15.7	14.1
29	33.1	22.1	17.5	15.3	13.7
30	32.5	21.6	16.9	14.9	13.3
35	29.3	19.5	15.3	12.9	11.6
40	26.0	17.0	13.5	11.6	10.2
50	21.6	14.3	11.4	9.7	8.6

Tables A.3.1 and A.3.3 were calculated by R. Albert (October, 1993) by computer simulation involving several runs of approximately 7000 cycles each for each value, and then smoothed. Although Table A.3.1 is strictly applicable only to a balanced design (same number of replicates from all laboratories), it can be applied to an unbalanced design without too much error, if there are only a few deviations.

A.3.2 Calculation of Cochran maximum variance outlier ratio

**COMPENDIUM OF INTERNATIONAL METHODS OF ANALYSIS – OIV
Protocol for collaborative studies**

Compute the within-laboratory variance for each laboratory and divide the largest of these variances by the sum of the all of the variances and multiply by 100. The resulting quotient is the Cochran statistic which indicates the presence of a removable outlier if this quotient exceed the critical value listed above in the Cochran table for the number of replicates and laboratories specified.

A.3.3 Critical values for the Grubbs extreme deviation outlier tests at the 2.5% (2-tail), 1.25% (1tail) rejection level, expressed as the percent reduction in standard deviations caused by the removal of the suspect value(s).

No. of labs	One highest or lowest	Two highest or two lowest	One highest and one lowest
4	86.1	98.9	99.1
5	73.5	90.9	92.7
6	64.0	81.3	84.0
7	57.0	73.1	76.2
8	51.4	66.5	69.6
9	46.8	61.0	64.1
10	42.8	56.4	59.5
11	39.3	52.5	55.5
12	36.3	49.1	52.1
13	33.8	46.1	49.1
14	31.7	43.5	46.5
15	29.9	41.2	44.1
16	28.3	39.2	42.0
17	26.9	37.4	40.1
18	25.7	35.9	38.4
19	24.6	34.5	36.9
20	23.6	33.2	35.4
21	22.7	31.9	34.0
22	21.9	30.7	32.8
23	21.2	29.7	31.8
24	20.5	28.8	30.8
25	19.8	28.0	29.8
26	19.1	27.1	28.9
27	18.4	26.2	28.1
28	17.8	25.4	27.3
29	17.4	24.7	26.6
30	17.1	24.1	26.0
40	13.3	19.1	20.5
50	11.1	16.2	17.3

A.3.4 Calculation of the Grubbs test values

To calculate the single Grubbs test statistic, compute the average for each laboratory and then calculate the standard deviation (M) of these L averages (designate as the original s). Calculate the SD of the set of averages with the highest average removed (SH); calculate the SD of the set of averages with the lowest average removed (SL). Then calculate the percentage decrease in SD for both as follows:

$$100 \times [1 - (sL/s)] \text{ and } 100 \times [1 - (sH/s)].$$

The higher of these two percentage decreases is the single Grubbs test statistic, which signals the presence of an outlier to be omitted at the $P = 2.5\%$ level, 2-tail, if it exceeds the critical value listed in the single value column, Column 2, of Table A.3.3, for the number of laboratory averages used to calculate the original s.

To calculate the paired Grubbs test statistics, calculate the percentage decrease in standard deviation obtained by dropping the two highest averages and also by dropping the two lowest averages, as above. Compare the higher of the percentage changes in standard deviation with the tabular values in column 3 and proceed with (1) or (2): (1) If the tabular value is exceeded, remove the responsible pair. Repeat the cycle again, starting at the beginning with the Cochran extreme variance test again, the Grubbs extreme value test, and the paired Grubbs extreme value test. (2) If no further values are removed, then calculate the percentage change in standard deviation obtained by dropping both the highest extreme value and the lowest extreme value together, and compare with the tabular values in the last column of A.3.3. If the tabular value is exceeded, remove the high-low pair of averages, and start the cycle again with the Cochran test until no further values are removed. In all cases, stop outlier testing when more than 22.2% (2/9) of the averages are removed.

APPENDIX 4

A.4.1. Flowchart for outlier removal

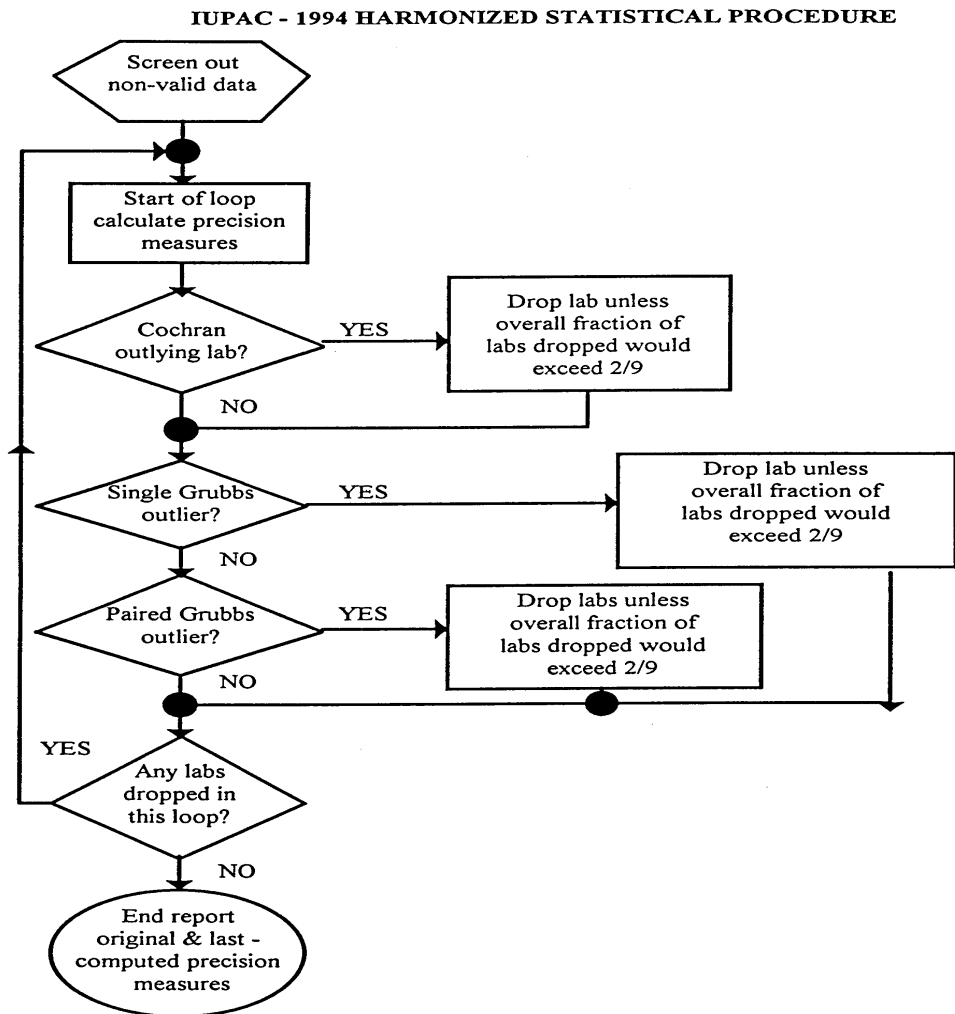

Estimation of the detection and quantification limits of a method of analysis

(Resolution Oeno 7/2000)

1 - Purpose: to establish the detection and quantification limits of a method

N.B. : The proposed calculation procedure sets « detection and quantification limiting » values with respect to the instrumental response. For a given method, the final calculation of these values must take cognizance of factors arising from the preparation of the sample.

2 - Definitions

- Detection limit: the smallest concentration or proportion of the analyzed substance that can be detected with an acceptable level of uncertainty, but that is not quantified under the experimental conditions described in the method
- Quantification limit: the smallest concentration or proportion of the analyzed substance that can be quantified with an acceptable level of uncertainty, under the experimental conditions described in the method.

3 – Logic Diagram for Decision-Making

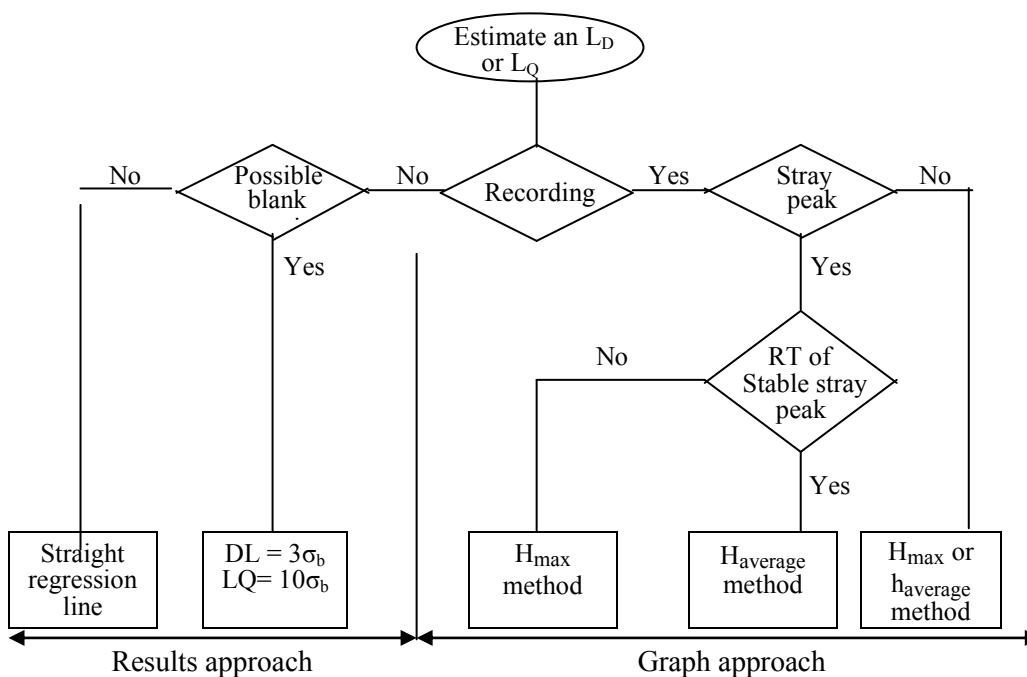

4 - Methodology

4.1 "Results" approach

When the analytical method produces no recorded graph, but only numerical values (i.e., colorimetry), the detection limit (L_D) and the quantification limit (L_Q) are estimated using one of the two following methods.

4.1.1 - Method 1:

Directly read n measurements (analyte quantity or response) of separate analytic « blank » samples that contain all of the constituents, with the exception of the substance to be tested for.

$$L_D = m_{\text{blank}} + 3S_{\text{blank}} \text{ and}$$

$$L_Q = m_{\text{blank}} + 10S_{\text{blank}}$$

where m_{blank} and S_{blank} are the mean and standard deviation for n measurements.

Note: A multiplication factor of 3 corresponds to a 0.13% chance of concluding that the substance sought is present, when, in fact, it is lacking. 10 corresponds to a 0.5% chance.

4.1.2 - Method 2:

Using the straight calibration line: $Y = a + bX$

The detection limit is the smallest concentration of a substance that can be distinguished from the blank, with a 0.13% risk of retaining samples containing nothing ; in other words, the value beginning at which a statistical test comparing the response to 0 becomes significant with an error level α of 0.13%. Hence:

$$Y_{DL} = a + 3S_a$$

$$X_{DL} = (a + 3S_a)/b$$

Where S_a is the standard deviation on the ordinate at the origin of the straight regression line. The logic is the same for L_Q , where the multiplication factor is 10 (risk of 0.5%).

4.2 - "Graph" Approach

For analytical methods which generate graphs (i.e., chromatography), the detection limit is estimated based on the ground noise of the analytic blank recording for a given sample.

$$L_D = 3 \times h \times R \text{ (associated risk is below 0.13\%)} \text{ and}$$

$$L_Q = 10 \times h \times R \text{ (associated risk is below 0.5\%), where}$$

- h is the average or maximum amplitude of the signal window corresponding to 10 width s of the mid-height peak on either side of the retention time, as a function of stability.

- R is the quantity/signal response factor expressed as a function of the quantity of substance/height.
On each occasion, three series of three injections each are performed on test blanks at an interval of several days.

4.2.1 h_{\max} method

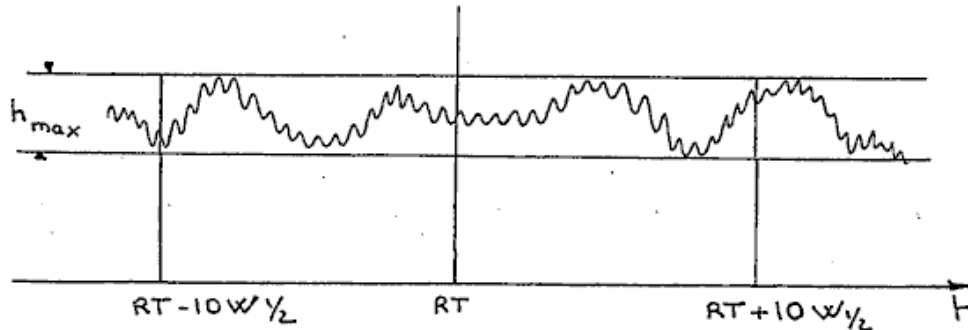

- Increase ground noise to the maximum (Fig. 1 above) ;
- center around the retention time (RT) of the product ;
- draw a window of 10 widths of the mid-height peak ($W_{1/2}$) on either side of the RT ;
- draw two parallel lines, one running through the highest point of the highest peak, the other through the base of the deepest trough ;
- evaluate height $\rightarrow h_{\max}$;
- calculate the response factor (R factor) ;
- $L_{D\max} = 3 \times h_{\max} \times R$
- $L_{Q\max} = 10 \times h_{\max} \times R$

4.2.2 h_{average} Method

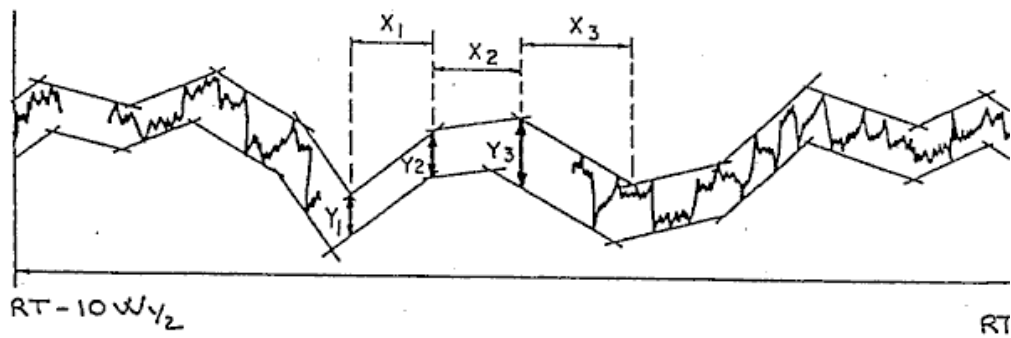

- increase the ground noise to the maximum (Fig. 2 above) ;
- center around the retention time (RT) of the product ;
- draw a window of 10 widths of the mid-height peak ($W_{1/2}$) on either side of the RT ;
- divide into 20 equal sections (x) ;
- draw two parallel lines in each block, one running through the highest point of the highest peak, the other through the base of the deepest trough ;
- measure the heights, y ;
- calculate the average ($y = h_{\text{average}}$);
- calculate the response factor (R factor);
- $L_{\text{Daverage}} = 3 \times h_{\text{average}} \times R$;
- $L_{\text{Qaverage}} = 10 \times h_{\text{average}} \times R$

These estimates can themselves be validated by injecting quantities of solute that are close to the calculated limits (Figures 3 and 4).

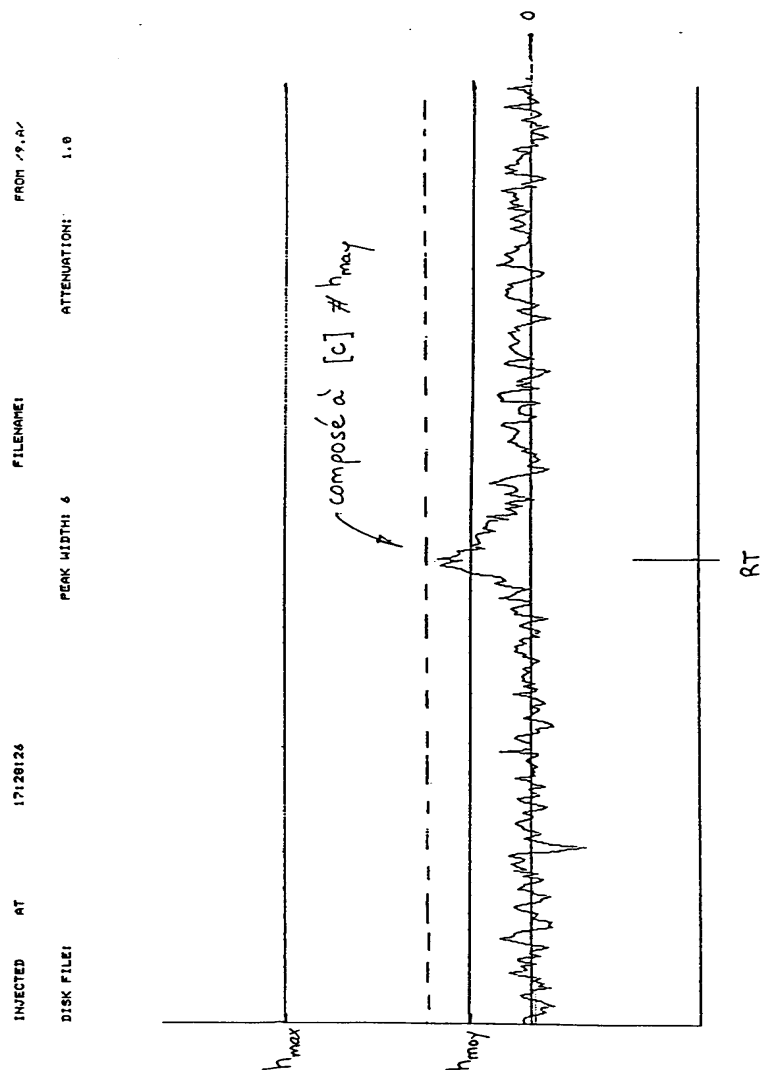

Compound at [c] # h_{max}

Figure No. 3: Validating calculations of limits.
Concentration of the compound approaches $H_{average}$

N.B.: The dotted line corresponds to the real injected value however, since this figure is provided as an example, it may be deleted from the final text.

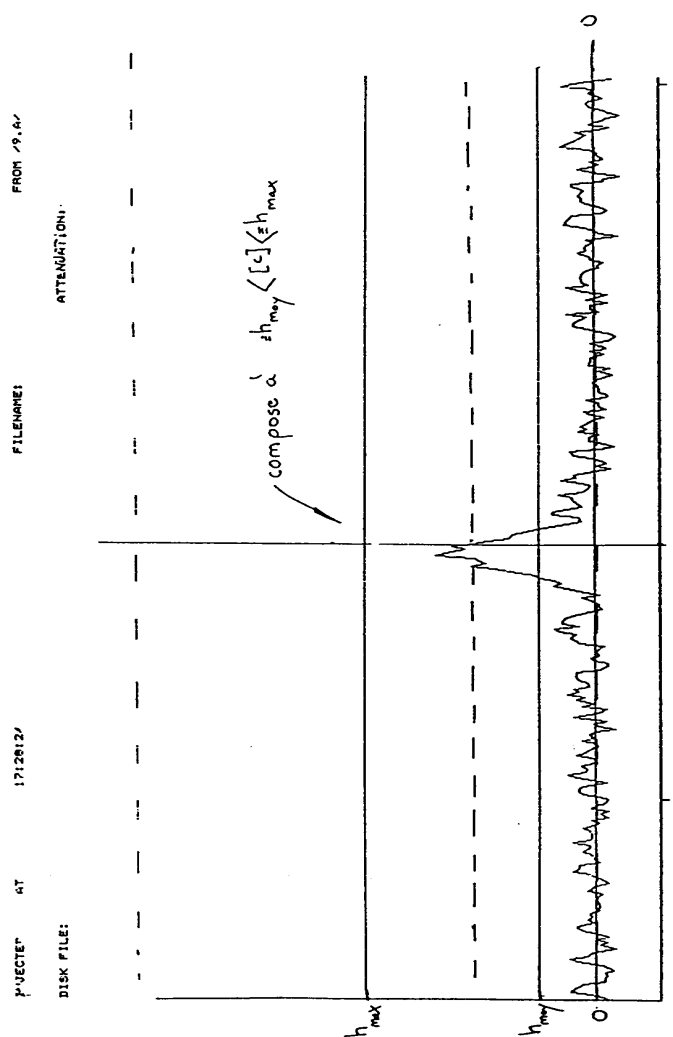

Compound at $h_{average} < [c] < \approx h_{max}$

Figure No. 4: Validating calculations of limits.
 Concentration of compound between $H_{average}$ and H_{max}

N.B. : The dotted line corresponds to the real injected value; however, since this figure is provided as an example, it may be deleted from the final text.

**Harmonized guidelines for internal quality control
in analytical chemistry laboratories**

(Resolution Oeno 19/2002)

CONTENTS

1. INTRODUCTION

- 1.1 Basic concepts**
- 1.2. Scope of this document**
- 1.3. Internal quality control and uncertainties**

2. DEFINITIONS

- 2.1. International definitions**
- 2.2. Definition of terms specific to this document**

3. QUALITY ASSURANCE PRACTICES AND INTERNAL QUALITY CONTROL

- 3.1. Quality assurance**
- 3.2. Choice of analytical method**
- 3.3. Quality control and aptitude tests**

4. INTERNAL QUALITY CONTROL PROCEDURES

- 4.1. Introduction**
- 4.2. General approach. Statistical control**
- 4.3. Internal quality control and fitness for purpose**
- 4.4. The nature of errors**

5. IQC AND WITHIN-RUN PRECISION

- 5.1. Precision and duplication**
- 5.2. Interpretation of duplicate data**

6. CONTROL MATERIALS IN IQC

- 6.1. Introduction**
- 6.2. The role of certified reference materials**
- 6.3. Preparation of control material**

**COMPENDIUM OF INTERNATIONAL METHODS OF ANALYSIS –OIV
Harmonized guidelines for internal quality control in analytical
chemistry laboratories**

6.4. Blank determinations

6.5. Traceability in spiking and recovery checks

7. RECOMMENDATIONS

8. CONCLUSIONS

9. REFERENCES

APPENDIX 1. SHEWHART CONTROL CHARTS

1. INTRODUCTION

1.1 Basic concept

This document sets out guidelines for the implementation of internal quality control (IQC) in analytical laboratories. IQC is one of a number of concerted measures that analytical chemists can take to ensure that the data produced in the laboratory are fit for their intended purpose. In practice, fitness for purpose is determined by a comparison of the accuracy achieved in a laboratory at a given time with a required level of accuracy. Internal quality control therefore comprises the routine practical procedures that enable the analytical chemist to accept a result or group of results as fit for purpose, or reject the results and repeat the analysis. As such, IQC is an important determinant of the quality of analytical data, and is recognised as such by accreditation agencies.

Internal quality control is undertaken by the inclusion of particular reference materials, here called "control materials", into the analytical sequence and by duplicate analysis. The control materials should, wherever possible, be representative of the test materials under consideration in respect of matrix composition, the state of physical preparation and the concentration range of the analyte. As the control materials are treated in exactly the same way as the test materials, they are regarded as surrogates that can be used to characterise the performance of the analytical system, both at a specific time and over longer intervals.

Internal quality control is a final check of the correct execution of all of the procedures (including calibration) that are prescribed in the analytical protocol and all of the other quality assurance measures that underlie good analytical practice. IQC is therefore necessarily retrospective. It is also required to be as far as possible independent of the analytical protocol, especially the calibration, that it is designed to test.

Ideally both the control materials and those used to create the calibration should be traceable to appropriate certified reference materials or a recognised empirical reference method. When this is not possible, control materials should be traceable at least to a material of guaranteed purity or other well characterised material. However, the two paths of traceability must not become coincident at too late a stage in the analytical process. For instance, if control materials and calibration standards were prepared from a single stock solution of analyte, IQC would not detect any inaccuracy stemming from the incorrect preparation of the stock solution.

**COMPENDIUM OF INTERNATIONAL METHODS OF ANALYSIS –OIV
Harmonized guidelines for internal quality control in analytical
chemistry laboratories**

In a typical analytical situation several, or perhaps many, similar test materials will be analysed together, and control materials will be included in the group. Often determinations will be duplicated by the analysis of separate test portions of the same material. Such a group of materials is referred to in this document as an analytical "run". (The words "set", "series" and "batch" have also been used as synonyms for "run".) Runs are regarded as being analysed under effectively constant conditions. The batches of reagents, the instrument settings, the analyst, and the laboratory environment will, under ideal conditions, remain unchanged during analysis of a run. Systematic errors should therefore remain constant during a run, as should the values of the parameters that describe random errors. As the monitoring of these errors is of concern, the run is the basic operational unit of IQC.

A run is therefore regarded as being carried out under repeatability conditions, *i.e.*, the random measurement errors are of a magnitude that would be encountered in a "short" period of time. In practice the analysis of a run may occupy sufficient time for small systematic changes to occur. For example, reagents may degrade, instruments may drift, minor adjustments to instrumental settings may be called for, or the laboratory temperature may rise. However, these systematic effects are, for the purposes of IQC, subsumed into the repeatability variations. Sorting the materials making up a run into a randomised order converts the effects of drift into random errors.

1.2 Scope of this document

This document is a harmonisation of IQC procedures that have evolved in various fields of analysis, notably clinical biochemistry, geochemistry and environmental studies, occupational hygiene and food analysis⁽³⁻⁹⁾. There is much common ground in the procedures from these various fields. Analytical chemistry comprises an even wider range of activities and the basic principles of IQC should be able to encompass all of these. The present document provides guidelines that will be applicable in most instances. This policy necessarily excludes a number of IQC practices that are restricted to individual sectors of the analytical community. In addition in some sectors it is common to combine IQC as defined here with other aspects of quality assurance practice. There is no harm in such combination, but it must remain clear what are the essential aspects of IQC.

**COMPENDIUM OF INTERNATIONAL METHODS OF ANALYSIS –OIV
Harmonized guidelines for internal quality control in analytical
chemistry laboratories**

In order to achieve a harmonisation and provide basic guidance on IQC, some types of analytical activity have been excluded from this document. Issues specifically excluded are as follows.

(i) *Quality control of sampling.* While it is recognised that the quality of the analytical result can be no better than that of the sample, quality control of sampling is a separate subject and in many areas is not fully developed. Moreover, in many instances analytical laboratories have no control over sampling practice and quality.

(ii) *In-line analysis and continuous monitoring.* In this style of analysis there is no possibility of repeating the measurement, so the concept of IQC as used in this document is inapplicable.

(iii) *Multivariate IQC.* Multivariate methods in IQC are still the subject of research and cannot be regarded as sufficiently established for inclusion here. The current document regards multianalyte data as requiring a series of univariate IQC tests. Caution is necessary in the interpretation of this type of data to avoid inappropriately frequent rejection of data.

(iv) *Statutory and contractual requirements.*

(v) *Quality assurance measures* such as checks on instrumental stability before and during analysis, wavelength calibration, balance calibration, tests on resolution of chromatography columns, and problem diagnostics are not included. For present purposes they are regarded as part of the analytical protocol, and IQC tests their effectiveness together with the other aspects of the methodology.

1.3 Internal quality control and uncertainty

A prerequisite of analytical chemistry is the recognition of "fitness for purpose", the standard of accuracy that is required for an effective use of the analytical data. This standard is arrived at by consideration of the intended uses of the data although it is seldom possible to foresee all of the potential future applications of analytical results. For this reason in order to prevent inappropriate interpretation, it is important that a statement of the uncertainty should accompany analytical results, or be readily available to those who wish to use the data.

COMPENDIUM OF INTERNATIONAL METHODS OF ANALYSIS –OIV
Harmonized guidelines for internal quality control in analytical
chemistry laboratories

Strictly speaking, an analytical result cannot be interpreted unless it is accompanied by knowledge of its associated uncertainty at a stated level of confidence. A simple example demonstrates this principle. Suppose that there is a statutory requirement that a foodstuff must not contain more than $10 \mu\text{g g}^{-1}$ of a particular constituent. A manufacturer analyses a batch and obtains a result of $9 \mu\text{g g}^{-1}$ for that constituent. If the uncertainty of the result expressed as a half range (assuming no sampling error) is $0.1 \mu\text{g g}^{-1}$ (i.e. the true result falls, with a high probability, within the range 8.9-9.1) then it may be assumed that the legal limit is not exceeded. If, in contrast, the uncertainty is $2 \mu\text{g g}^{-1}$ then there is no such assurance. The interpretation and use that may be made of the measurement thus depends on the uncertainty associated with it.

Analytical results should therefore have an associated uncertainty if any definite meaning is to be attached to them or an informed interpretation made. If this requirement cannot be fulfilled, the use to which the data can be put is limited. Moreover, the achievement of the required measurement uncertainty must be tested as a routine procedure, because the quality of data can vary, both in time within a single laboratory and between different laboratories. IQC comprises the process of checking that the required uncertainty is achieved in a run.

2. DEFINITIONS

2.1 International definitions

Quality assurance. All those planned and systematic actions necessary to provide adequate confidence that a product or service will satisfy given requirements for quality⁽¹⁰⁾.

Trueness: closeness of the agreement between the average value obtained from a large series of test results and an accepted reference value⁽¹¹⁾.

Precision: closeness of agreement between independent test results obtained under prescribed conditions⁽¹²⁾.

Bias: difference between the expectation of the test results and an accepted reference value⁽¹¹⁾.

**COMPENDIUM OF INTERNATIONAL METHODS OF ANALYSIS –OIV
Harmonized guidelines for internal quality control in analytical
chemistry laboratories**

Accuracy: closeness of the agreement between the result of a measurement and a true value of the measurand⁽¹³⁾.

Note 1. Accuracy is a qualitative concept.

Note 2. The term *precision* should not be used for *accuracy*.

Error: result of a measurement minus a true value of the measurand⁽¹³⁾.

Repeatability conditions. conditions where independent test results are obtained with the same method on identical test items in the same laboratory by the same operator using the same equipment within short intervals of time⁽¹¹⁾.

Uncertainty of measurement: parameter, associated with the result of a measurement, that characterises the dispersion of the values that could reasonably be attributed to the measurand⁽¹⁴⁾.

Note 1. The parameter may be, for example, a standard deviation (or a given multiple of it), or the half-width of an interval having a stated level of confidence.

Note 2. Uncertainty of measurement comprises, in general, many components. Some of these components may be evaluated from the statistical distribution of results of a series of measurements and can be characterised by experimental standard deviations. The other components, which can also be characterised by standard deviations, are evaluated from assumed probability distributions based on experience or other information.

Note 3. It is understood that the result of a measurement is the best estimate of the value of a measurand, and that all components of uncertainty, including those arising from systematic effects, such as components associated with corrections and reference standards, contribute to the dispersion.

Traceability: property of the result of a measurement or the value of a standard whereby it can be related to stated references, usually national or international standards, through an unbroken chain of comparisons all having stated uncertainties⁽¹³⁾.

Reference material: material or substance one of whose property values are sufficiently homogeneous and well established to be used for the

**COMPENDIUM OF INTERNATIONAL METHODS OF ANALYSIS –OIV
Harmonized guidelines for internal quality control in analytical
chemistry laboratories**

calibration of an apparatus, the assessment of a measurement method, or for assigning values to materials⁽¹³⁾.

Certified reference material: reference material, accompanied by a certificate, one or more of whose property values are certified by a procedure which establishes its traceability to an accurate realisation of the unit in which the property values are expressed, and for which each certified value is accompanied by an uncertainty at a stated level of confidence⁽¹³⁾.

2.2 Definitions of terms specific to this document

Internal quality control: set of procedures undertaken by laboratory staff for the continuous monitoring of operation and the results of measurements in order to decide whether results are reliable enough to be released.

Control material: material used for the purposes of internal quality control and subjected to the same or part of the same measurement procedure as that used for test materials.

Run (analytical run): set of measurements performed under repeatability conditions.

Fitness for purpose: degree to which data produced by a measurement process enables a user to make technically and administratively correct decisions for a stated purpose

Analytical system: range of circumstances that contribute to the quality of analytical data, including equipment, reagents, procedures, test materials, personnel, environment and quality assurance measures.

3. QUALITY ASSURANCE PRACTICES AND INTERNAL QUALITY CONTROL

3.1 Quality assurance

Quality assurance is the essential organisational infrastructure that underlies all reliable analytical measurements. It is concerned with achieving appropriate levels in matters such as staff training and management, adequacy of the laboratory environment, safety, the storage, integrity and identity of samples, record keeping, the maintenance and

calibration of instruments, and the use of technically validated and properly documented methods . Failure in any of these areas might undermine vigorous efforts elsewhere to achieve the desired quality of data. In recent years these practices have been codified and formally recognised as essential. However, the prevalence of these favourable circumstances by no means ensures the attainment of appropriate data quality unless IQC is conducted.

3.2 Choice of analytical method

It is important that laboratories restrict their choice of methods to those that have been characterised as suitable for the matrix and analyte of interest. The laboratory must possess documentation describing the performance characteristics of the method, estimated under appropriate conditions.

The use of a method does not in itself guarantee the achievement of its established performance characteristics. There is, for a given method, only the potential to achieve a certain standard of reliability when the method is applied under a particular set of circumstances. It is this collection of circumstances, known as the "analytical system", that is therefore responsible for the accuracy of analytical data. Hence it is important to monitor the analytical system in order to achieve fitness for purpose. This is the aim of the IQC measures undertaken in a laboratory.

3.3 Internal quality control and proficiency tests

Proficiency testing is a periodic assessment of the performance of individual laboratories and groups of laboratories that is achieved by the distribution by an independent testing body of typical materials for unsupervised analysis by the participants⁽²⁾. Although important, participation in proficiency testing schemes is not a substitute for IQC measures, or *vice versa*.

Proficiency testing schemes can be regarded as a routine, but relatively infrequent, check on analytical errors. Without the support of a well-developed IQC system, the value of participation in a proficiency test is negligible. Probably the main beneficial effect of proficiency tests is that of encouraging participants to install effective quality control systems. It has been shown that laboratories with effective IQC systems performed better in a proficiency testing scheme⁽¹⁵⁾.

4. INTERNAL QUALITY CONTROL PROCEDURES

4.1 Introduction

Internal quality control involves the practical steps undertaken to ensure that errors in analytical data are of a magnitude appropriate for the use to which the data will be put. The practice of IQC depends on the use of two strategies, the analysis of reference materials to monitor trueness and statistical control, and duplication to monitor precision.

The basic approach to IQC involves the analysis of control materials alongside the test materials under examination. The outcome of the control analyses forms the basis of a decision regarding the acceptability of the test data. Two key points are worth noting in this context.

- (i) The interpretation of control data must be based on documented, objective criteria, and on statistical principles wherever possible.
- (ii) The results of control analyses should be viewed primarily as indicators of the performance of the analytical system, and only secondarily as a guide to the errors associated with individual test results. Substantial changes in the apparent accuracy of control determinations can sometimes be taken to imply similar changes to data for contemporary test materials, but correction of analytical data on the basis of this premise is unacceptable.

4.2 General Approach - Statistical Control

The interpretation of the results of IQC analyses depends largely on the concept of statistical control, which corresponds with stability of operation. Statistical control implies that an IQC result x can be interpreted as arising independently and at random from a normal population with mean μ and variance σ^2 .

Under these constraints only about 0.27% of results (x) would fall outside the bounds of $\mu \pm 3\sigma$. When such extreme results are encountered they are regarded as being "out-of-control" and interpreted to mean that the analytical system has started to behave differently. Loss of control therefore implies that the data produced by the system are of unknown accuracy and hence cannot be relied upon. The analytical system therefore requires investigation and remedial action before further analysis is undertaken. Compliance with statistical control can be monitored graphically with Shewhart control charts (see Appendix 1). An equivalent

numerical approach, comparing values of $z = (x-\mu)/\sigma$ against appropriate values of the standard normal deviate, is also possible.

4.3 Internal quality control and fitness for purpose.

For the most part, the process of IQC is based on a description in terms of the statistical parameters of an ongoing analytical system in normal operation. Control limits are therefore based on the estimated values of these parameters rather than measures derived from considerations of fitness for purpose. Control limits must be narrower than the requirements of fitness for purpose or the analysis would be futile.

The concept of statistical control is inappropriate, however, when the so-called *ad hoc* analysis is being undertaken. In *ad hoc* analysis the test materials may be unfamiliar or rarely encountered, and runs are often made up of only a few such test materials. Under these circumstances there is no statistical basis for the construction of control charts. In such an instance the analytical chemist has to use fitness for purpose criteria, historical data or consistency with the visual properties of the test material for judging the acceptability of the results obtained.

Either way, agreed methods of establishing quantitative criteria to characterise fitness for purpose would be desirable. Unfortunately, this is one of the less-developed aspects of IQC. In specific application areas guidelines may emerge by consensus. For example, in environmental studies it is usually recognised that relative uncertainties of less than ten percent in the concentration of a trace analyte are rarely of consequence. In food analysis the Horwitz curve⁽¹⁶⁾ is sometimes used as a fitness for purpose criterion. Such criteria have been defined for clinical analysis^(17,18). In some areas of applied geochemistry a systematic approach has given rise to fitness for purpose criteria for sampling and analytical precisions. However, it is not practicable here to give guidelines in these areas, and at present no general principles can be advanced that would allow specific applications to be addressed.

4.4 The nature of errors

Two main categories of analytical error are recognised, namely random errors and systematic errors, which give rise to imprecision and bias respectively. The importance of categorising errors in this way lies in the fact that they have different sources, remedies and consequences for the interpretation of data.

**COMPENDIUM OF INTERNATIONAL METHODS OF ANALYSIS –OIV
Harmonized guidelines for internal quality control in analytical
chemistry laboratories**

Random errors determine the precision of measurement. They cause random positive and negative deviations of results about the underlying mean value. *Systematic errors* comprise displacement of the mean of many determinations from the true value. For the purposes of IQC two levels of systematic error are worth consideration.

(i) *Persistent bias* affects the analytical system (for a given type of test material) over a long period and affects all data. Such bias, if small in relation to random error, may be identifiable only after the analytical system has been in operation for a long time. It might be regarded as tolerable, provided it is kept within prescribed bounds.

(ii) *The run effect* is exemplified by a deviation of the analytical system during a particular run. This effect, where it is sufficiently large, will be identified by IQC at the time of occurrence as an out-of-control condition.

The conventional division of errors between the random and the systematic depends on the timescale over which the system is viewed. Run effects of unknown source can be regarded in the long-term as the manifestation of a random process. Alternatively, if a shorter-term view is taken, the same variation could be seen as a bias-like change affecting a particular run.

The statistical model used for IQC in this document is as follows¹. The value of a measurement (x) in a particular run is given by:

$x = \text{true value} + \text{persistent bias} + \text{run effect} + \text{random error} (+ \text{gross error}).$

The variance of x (σ_x^2) in the absence of gross errors is given by:

$$\sigma_x^2 = \sigma_0^2 + \sigma_1^2$$

where

σ_0^2 = variance of the random error (within run) and

σ_1^2 = variance of the run effect.

¹ The model could be extended if necessary to include other features of the analytical system

The variances of the true value and the persistent bias are both zero. An analytical system in control is fully described by σ_0^2 , σ_1^2 and the value of the persistent bias. Gross errors are implied when the analytical system does not comply with such a description.

5 IQC AND WITHIN-RUN PRECISION

5.1 Precision and duplication

A limited control of within-run precision is achieved by the duplication within a run of measurements made on test materials. The objective is to ensure that the differences between paired results are consistent with or better than the level implied by the value of σ_0 used by a laboratory for IQC purposes². Such a test alerts the user to the possibility of poor within-run precision and provides additional information to help in interpreting control charts. The method is especially useful in *ad hoc* analysis, where attention is centred on a single run and information obtained from control materials is unlikely to be completely satisfactory.

As a general approach all of the test materials, or a random selection from them, are analysed in duplicate. The absolute differences $|d| = |x_1 - x_2|$ between duplicated analytical results x_1 and x_2 are tested against an upper control limit based on an appropriate value of σ_0 . However, if the test materials in the run have a wide range of concentration of analyte, no single value of σ_0 can be assumed⁽¹⁹⁾.

Duplicates for IQC must reflect as far as possible the full range of variation present in the run. They must not be analysed as adjacent members of the run, otherwise they will reveal only the smallest possible measure of analytical variability. The best placing of duplicates is at random within each run. Moreover the duplication required for IQC requires the complete and independent analysis (preferably blind) of separate test portions of the test material. A duplication of the instrumental measurement of a single test solution would be ineffective because the variations introduced by the preliminary chemical treatment of the test material would be absent.

²There is no intention here of estimating the standard deviation of repeatability σ_r from the IQC data or of comparing estimates: there would usually be too few results for a satisfactory outcome. Where such an estimate is needed the formula $s_r = \sqrt{\sum d^2 / 2n}$ can be used.

5.2 Interpretation of duplicate data

5.2.1 Narrow concentration range. In the simplest situation the test materials comprising the run have a small range of analyte concentrations so that a common within-run standard deviation σ_0 can be applied.

A value of this parameter must be estimated to provide a control limit. The upper 95% bound of $|d|$ is $2\sqrt{2}\sigma_0$ and on average only about three in a thousand results should exceed $3\sqrt{2}\sigma_0$. A group of n duplicated results can be interpreted in several ways.

For example, the standardised difference

$$z_d = d/\sqrt{2}\sigma_0$$

should have a normal distribution with zero mean and unit standard deviation. The sum of a group of n such results would have a standard deviation of \sqrt{n} so only about three runs in a thousand would produce a value of $|\sum z_d| > 3\sqrt{n}$. Alternatively a group of n values of z_d from a run can be combined to form $\sum z_d^2$ and the result interpreted as a sample from a chi-squared distribution with n degrees of freedom, (χ_n^2). Some caution is needed in the use of this statistic, however, as it is sensitive to outlying results.

5.2.2 Wide concentration range. If the test materials comprising a run have a wide range of analyte concentrations, no common standard of precision (σ_0) can be assumed. In such an instance σ_0 must be expressed as a functional relationship with concentration. The value of concentration for a particular material is taken to be $(x_1 + x_2)/2$, and an appropriate value of σ_0 obtained from the functional relationship, the parameters of which have to be estimated in advance.

6. CONTROL MATERIALS IN IQC

6.1 Introduction

Control materials are characterised substances that are inserted into the run alongside the test materials and subjected to exactly the same treatment. A

control material must contain an appropriate concentration of the analyte, and a value of that concentration must be assigned to the material. Control materials act as surrogates for the test materials and must therefore be representative, *i.e.*, they should be subject to the same potential sources of error. To be fully representative, a control material must have the same matrix in terms of bulk composition, including minor constituents that may have a bearing on accuracy. It should also be in a similar physical form, *i.e.*, state of comminution, as the test materials. There are other essential characteristics of a control material. It must be adequately stable over the period of interest. It must be possible to divide the control material into effectively identical portions for analysis. It is often required in large amounts to allow its use over an extended period.

Reference materials in IQC are used in combination with control charts that allow both persistent bias and run effects to be addressed (Appendix 1). Persistent bias is evident as a significant deviation of the centre line from the assigned value. The variation in the run effect is predictable in terms of a standard deviation when the system is under statistical control, and that standard deviation is used to define action limits and warning limits at appropriate distances from the true value.

6.2 The role of certified reference materials

Certified reference materials (CRM) as defined in Section 2 (*i.e.*, with a statement of uncertainty and traceability), when available and of suitable composition, are ideal control materials in that they can be regarded for traceability purposes as ultimate standards of trueness⁽²⁰⁾. In the past CRMs were regarded as being for reference purposes only and not for routine use. A more modern approach is to treat CRMs as consumable and therefore suitable for IQC.

The use of CRMs in this way is, however, subject to a number of constraints.

- (i) Despite the constantly increasing range of CRMs available, for the majority of analyses there is no closely matching CRM available.
- (ii) Although the cost of CRMs is not prohibitive in relation to the total costs of analysis, it may not be possible for a laboratory with a wide range of activities to stock every relevant kind of reference material.
- (iii) The concept of the reference material is not applicable to materials where either the matrix or the analyte is unstable.

(iv) CRMs are not necessarily available in sufficient amounts to provide for IQC use over extended periods.

(v) It must be remembered that not all apparently certified reference materials are of equal quality. Caution is suggested when the information on the certificate is inadequate.

If for any of the above reasons the use of a CRM is not appropriate it falls on individual laboratories or groups of laboratories to prepare their own control materials and assign traceable³ values of analyte concentration to them. Such a material is sometimes referred to as a "house reference material" (HRM). Suggestions for preparing HRMs are listed in Section 6.3. Not all of the methods described there are applicable to all analytical situations.

6.3 Preparation of control materials

6.3.1 Assigning a true value by analysis. In principle a working value can be assigned to a stable reference material simply by careful analysis. However, precautions are necessary to avoid biases in the assigned value. This requires some form of independent check such as may be provided by analysis of the materials in a number of laboratories and where possible, the use of methods based on different physico-chemical principles. Lack of attention to independent validation of control materials has been shown to be a weakness in IQC systems⁽¹⁵⁾.

One way of establishing a traceable assigned value in a control material is to analyse a run comprising the candidate material and a selection of matching CRMs, with replication and randomisation. This course of action would be appropriate if only limited amounts of CRMs were available. The CRMs must be appropriate in both matrix composition and analyte concentration. The CRMs are used directly to calibrate the analytical procedure for the analysis of the control material. An appropriate analytical method is a prerequisite for this approach. It would be a dangerous approach if, say, a minor and variable fraction of the analyte

³Where a CRM is not available traceability only to a reference method or to a batch of a reagent supplied by a manufacturer may be necessary.

were extracted for measurement. The uncertainty introduced into the assigned value must also be considered.

6.3.2 Materials validated in proficiency testing comprise a valuable source of control materials. Such materials would have been analysed by many laboratories using a variety of methods. In the absence of counter-indications, such as an obvious bias or unusual frequency distribution of results, the consensus of the laboratories could be regarded as a validated assigned value to which a meaningful uncertainty could be attached. (There is a possibility that the consensus could suffer from a bias of consequence, but this potential is always present in reference values.) There would be a theoretical problem of establishing the traceability of such a value, but that does not detract from the validity of the proposed procedure. The range of such materials available would be limited, but organisers of proficiency tests could ensure a copious supply by preparing batches of material in excess of the immediate requirements of the round. The normal requirements of stability would have to be demonstrable.

6.3.3 Assigning a true value by formulation. In favourable instances a control material can be prepared simply by mixing constituents of known purity in predetermined amounts. For example, this approach would often be satisfactory in instances where the control material is a solution. Problems are often encountered in formulation in producing solid control materials in a satisfactory physical state or in ensuring that the speciation and physical distribution of the analyte in the matrix is realistic. Moreover an adequate mixing of the constituents must be demonstrable.

6.3.4 Spiked control materials. "Spiking" is a way of creating a control material in which a value is assigned by a combination of formulation and analysis. This method is feasible when a test material essentially free of the analyte is available. After exhaustive analytical checks to ensure the background level is adequately low, the material is spiked with a known amount of analyte. The reference sample prepared in this way is thus of the same matrix as the test materials to be analysed and of known analyte level - the uncertainty in the assigned concentration is limited only by the possible error in the unspiked determination. However, it may be difficult to ensure that the speciation, binding and physical form of the added analyte is the same as that of the native analyte and that the mixing is adequate.

6.3.5 Recovery Checks. If the use of a reference material is not practicable then a limited check on bias is possible by a test of recovery. This is especially useful when analytes or matrices cannot be stabilised or when *ad*

hoc analysis is executed. A test portion of the test material spiked with a known amount of the analyte and analysed alongside the original test material. The recovery of the added analyte (known as the "marginal recovery") is the difference between the two measurements divided by the amount that is added. The obvious advantages of recovery checks are that the matrix is representative and the approach is widely applicable - most test materials can be spiked by some means. However, the recovery check suffers from the disadvantage previously noted regarding the speciation, binding and physical distribution of the analyte. Furthermore, the assumption of an equivalent recovery of the analyte added as a spike and of the native analyte may not be valid. However, it can normally be assumed that a poor performance in a recovery check is strongly indicative of a similar or worse performance for the native analyte in the test materials.

Spiking and recovery testing as an IQC method must be distinguished from the method of standard additions, which is a measurement procedure: a single spiking addition cannot be used to fulfil the roles of both measurement and IQC.

6.4 Blank determinations

Blank determinations are nearly always an essential part of the analytical process and can conveniently be effected alongside the IQC protocol. The simplest form of blank is the "reagent blank", where the analytical procedure is executed in all respects apart from the addition of the test portion. This kind of blank, in fact, tests more than the purity of the reagents. For example it is capable of detecting contamination of the analytical system originating from any source, *e.g.*, glassware and the atmosphere, and is therefore better described as a "procedural blank". In some instances, better execution of blank determinations is achieved if a simulated test material is employed. The simulant could be an actual test material known to be virtually analyte-free or a surrogate (*e.g.*, ashless filter paper used instead of plant material). Where it can be contrived, the best type of blank is the "field blank", which is a typical matrix with zero concentration of analyte.

An inconsistent set of blanks in a run suggests sporadic contamination and may add weight to IQC evidence suggesting the rejection of the results. When an analytical protocol prescribes the subtraction of a blank value, the blank value must be subtracted also from the results of the control materials before they are used in IQC.

6.5 Traceability in spiking and recovery checks

Potential problems of the traceability of reagents used for spikes and recovery checks must be guarded against. Under conditions where CRMs are not available, traceability can often be established only to the batch of analyte provided by a manufacturer. In such cases, confirmation of identity and a check on purity must be made before use. A further precaution is that the calibration standards and spike should not be traceable to the same stock solution of analyte or the same analyst. If such a common traceability existed, then the corresponding sources of error would not be detected by the IQC.

7. RECOMMENDATIONS

The following recommendations represent integrated approaches to IQC that are suitable for many types of analysis and applications areas. Managers of laboratory quality systems will have to adapt the recommendations to the demands of their own particular requirements. Such adaptation could be implemented, for example, by adjusting the number of duplicates and control material inserted into a run, or by the inclusion of any additional measures favoured in the particular application area. The procedure finally chosen and its accompanying decision rules must be codified in an IQC protocol that is separate from the analytical system protocol.

The practical approach to quality control is determined by the frequency with which the measurement is carried out and the size and nature of each run. The following recommendations are therefore made. The use of control charts and decision rules are covered in Appendix 1.

In each of the following the order in the run in which the various materials are analysed should be randomised if possible. A failure to randomise may result in an underestimation of various components of error.

(i) *Short (e.g., $n < 20$) frequent runs of similar materials.* Here the concentration range of the analyte in the run is relatively small, so a common value of standard deviation can be assumed.

Insert a control material at least once per run. Plot either the individual values obtained, or

The mean value, on an appropriate control chart. Analyse in duplicate at least half of the

Test materials, selected at random. Insert at least one blank determination.

COMPENDIUM OF INTERNATIONAL METHODS OF ANALYSIS –OIV
Harmonized guidelines for internal quality control in analytical
chemistry laboratories

(ii) *Longer (e.g., $n > 20$) frequent runs of similar materials.* Again a common level of standard deviation is assumed.

Insert the control material at an approximate frequency of one per ten test materials. If the run size is likely to vary from run to run it is easier to standardise on a fixed number of insertions per run and plot the mean value on a control chart of means. Otherwise plot individual values.

Analyse in duplicate a minimum of five test materials selected at random. Insert one blank determination per ten test materials.

(iii) *Frequent runs containing similar materials but with a wide range of analyte concentration.*

Here we cannot assume that a single value of standard deviation is applicable.

Insert control materials in total numbers approximately as recommended above. However, there should be at least two levels of analyte represented, one close to the median level of typical test materials, and the other approximately at the upper or lower decile as appropriate. Enter values for the two control materials on separate control charts. Duplicate a minimum of five test materials, and insert one procedural blank per ten test materials.

(iv) *Ad hoc analysis.* Here the concept of statistical control is not applicable. It is assumed, however, that the materials in the run are of a single type, *i.e.*, sufficiently similar for general conclusions on errors to be made.

Carry out duplicate analysis on all of the test materials. Carry out spiking or recovery tests or use a formulated control material, with an appropriate number of insertions (see above), and with different concentrations of analyte if appropriate. Carry out blank determinations. As no control limits are available, compare the bias and precision with fitness for purpose limits or other established criteria..

8. CONCLUSIONS

Internal quality control is an essential aspect of ensuring that data released from a laboratory are fit for purpose. If properly executed, quality control methods can monitor the various aspects of data quality on a run-by-run basis. In runs where performance falls outside acceptable limits, the data produced can be rejected and, after remedial action on the analytical system, the analysis can be repeated.

COMPENDIUM OF INTERNATIONAL METHODS OF ANALYSIS –OIV
Harmonized guidelines for internal quality control in analytical
chemistry laboratories

It must be stressed, however, that internal quality control is not foolproof even when properly executed. Obviously it is subject to "errors of both kinds", *i.e.*, runs that are in control will occasionally be rejected and runs that are out of control occasionally accepted. Of more importance, IQC cannot usually identify sporadic gross errors or short-term disturbances in the analytical system that affect the results for individual test materials. Moreover, inferences based on IQC results are applicable only to test materials that fall within the scope of the analytical method validation. Despite these limitations, which professional experience and diligence can alleviate to a degree, internal quality control is the principal recourse available for ensuring that only data of appropriate quality are released from a laboratory. When properly executed it is very successful.

Finally, it must be appreciated that a perfunctory execution of any quality system will not guarantee the production of data of adequate quality. The correct procedures for feedback, remedial action and staff motivation must also be documented and acted upon. In other words, there must be a genuine commitment to quality within a laboratory for an internal quality control programme to succeed, *i.e.*, the IQC must be part of a total quality management system.

9. REFERENCES

- 1 "Protocol for the Design, Conduct and Interpretation of Method Performance Studies", Edited W Horwitz, *Pure Appl. Chem.*, 1988, **60**, 855- 864. (*Revision in press*)
- 2 "The International Harmonised Protocol for the Proficiency Testing of (Chemical) Analytical Laboratories", Edited M Thompson and R Wood, *Pure Appl. Chem.*, 1993, **65**, 2123-2144. (Also published in *J. AOAC International*, 1993, **76**, 926-940.
- 3 "IFCC approved recommendations on quality control in clinical chemistry. Part 4: internal quality control", *J. Clin. Chem. Clin. Biochem.*, 1980, **18**, 534-541.
- 4 S Z Cekan, S B Sufi and E W Wilson, "Internal quality control for assays of reproductive hormones: Guidelines for laboratories". WHO, Geneva, 1993.
- 5 M Thompson, "Control procedures in geochemical analysis", in R J Howarth (Ed), "Statistics and data analysis in geochemical prospecting", Elsevier, Amsterdam, 1983.
- 6 M Thompson, "Data quality in applied geochemistry: the requirements and how to achieve them", *J. Geochem. Explor.*, 1992, **44**, 3-22.
- 7 Health and Safety Executive, "Analytical quality in workplace air monitoring", London, 1991.

**COMPENDIUM OF INTERNATIONAL METHODS OF ANALYSIS –OIV
Harmonized guidelines for internal quality control in analytical
chemistry laboratories**

- 8 "A protocol for analytical quality assurance in public analysts' laboratories", Association of Public Analysts, 342 Coleford Road, Sheffield S9 5PH, UK, 1986.
- 9 "Method evaluation, quality control, proficiency testing" (AMIQAS PC Program), National Institute of Occupational Health, Denmark, 1993.
- 10 ISO 8402:1994. "Quality assurance and quality management - vocabulary".
- 11 ISO 3534 -1: 1993 (E/F). "Statistics, vocabulary and symbols - Part 1: Probability and general statistical terms".
- 12 ISO Guide 30:1992. "Terms and definitions used in connections with reference materials"
- 13 "International vocabulary for basic and general terms in metrology" , 2nd Edition, 1993, ISO, Geneva.
- 14 "Guide to the expression of uncertainty in measurement", ISO, Geneva, 1993.
- 15 M Thompson and P J Lowthian, *Analyst*, 1993, **118**, 1495-1500.
- 16 W Horwitz, L R Kamps and K W Boyer, *J. Assoc. Off. Anal. Chem.*, 1980, **63**, 1344.
- 17 D Tonks, *Clin. Chem.*, 1963, **9**, 217-223.
- 18 G C Fraser, P H Petersen, C Ricos and R Haeckel, "Proposed quality specifications for the imprecision and inaccuracy of analytical systems for clinical chemistry", *Eur. J. Clin. Chem. Clin. Biochem.*, 1992, **30**, 311-317.
- 19 M Thompson, *Analyst*, 1988, **113**, 1579-1587.
- 20 ISO Guide 33: 1989, "Uses of Certified Reference Materials", Geneva.

APPENDIX 1. SHEWHART CONTROL CHARTS

1. INTRODUCTION

The theory, construction and interpretation of the Shewhart chart⁽¹⁾ are detailed in numerous texts on process quality control and applied statistics, and in several ISO standards⁽²⁻⁵⁾. There is a considerable literature on the use of the control chart in clinical chemistry^(6,7). Westgard and co-workers have formulated multiple rules for the interpretation of such control charts⁽⁸⁾, and the power of these results has been studied in detail⁽⁹⁻¹⁰⁾. In this appendix only simple Shewhart charts are considered.

In IQC a Shewhart control chart is obtained when values of concentration measured on a control material in successive runs are plotted on a vertical axis against the run number on the horizontal axis. If more than one analysis of a particular control material is made in a run, either the individual results x or the mean value \bar{x} can be used to form a control chart. The chart is completed by horizontal lines derived from the normal distribution $N(\mu, \sigma^2)$ that is taken to describe the random variations in the plotted values. The selected lines for control purposes are $\mu \pm 2\sigma$ and $\mu \pm 3\sigma$. Different values of σ are required for charts of individual values and of means. For a system in statistical control, on average about one in twenty values fall outside the $\mu \pm 2\sigma$ lines, called the "warning limits", and only about three in one thousand fall outside the $\mu \pm 3\sigma$ lines, the "action limits". In practice the estimates \bar{x} and s of the parameters μ and σ are used to construct the chart. A persistent bias is indicated by a significant difference between \bar{x} and the assigned value

2. ESTIMATES OF THE PARAMETERS μ and σ

An analytical system under control exhibits two sources of random variation, the within-run, characterised by variance σ_0^2 and the between-run with variance σ_1^2 . The two variances are typically comparable in magnitude. The standard deviation σ_x used in a chart of individual values is given by

$$\sigma_x = (\sigma_0^2 + \sigma_1^2)^{1/2}$$

whereas for a control chart of mean values the standard deviation is given by

$$\sigma_{\bar{x}} = (\sigma_0^2/n + \sigma_1^2)^{1/2}$$

COMPENDIUM OF INTERNATIONAL METHODS OF ANALYSIS –OIV
Harmonized guidelines for internal quality control in analytical
chemistry laboratories

where n is the number of control measurements in a run from which the mean is calculated. The value of n therefore must be constant from run to run, otherwise control limits would be impossible to define. If a fixed number of repeats of a control material per run cannot be guaranteed (e.g., if the run length were variable) then charts of individual values must be used. Furthermore the equation indicates that σ_x or $\sigma_{\bar{x}}$ must be estimated with care. An attempt to base an estimate on repeat values from a single run would result in unduly narrow control limits.

Estimates must therefore include the between-run component of variance. If the use of a particular value of n can be assumed at the outset, then $\sigma_{\bar{x}}$ can be

estimated directly from the m means $\bar{x}_i = \sum_{j=1}^n x_{ij} / n$

($i = 1, \dots, m$) of the n repeats in each of m successive runs.

Thus the estimate of μ is

$$\bar{x} = \sum_i \bar{x}_i / m$$

and the estimate of $\sigma_{\bar{x}}$ is

$$s_{\bar{x}} = \sqrt{\frac{\sum_i (\bar{x}_i - \bar{x})^2}{m-1}}$$

If the value of n is not predetermined, then separate estimates of σ_0 and σ_1 could be obtained by one-way analysis of variance. If the mean squares within- and between- groups are MS_w and MS_b respectively, then

σ_0^2 is estimated by MS_w and

σ_1^2 is estimated by $(MS_b - MS_w)/n$

Often in practice it is necessary to initiate a control chart with data collected from a small number of runs, which may be to a degree unrepresentative, as estimates of standard deviation are very variable unless large numbers of observations are used. Moreover, during the initial period, the occurrence of out-of-control conditions are

more than normally likely and will produce outlying values. Such values would bias \bar{x} and inflate s beyond its proper value. It is therefore advisable to recalculate \bar{x} and s after a further "settling down" period. One method of obviating the effects of outliers in the calculation is to reject them after the application of Dixon's Q or Grubbs⁽¹¹⁾ test, and then use the classical statistics given above. Alternatively, the methods of robust statistics could be applied to the data^(12, 13).

3. THE INTERPRETATION OF CONTROL CHARTS

The following simple rules can be applied to control charts of individual results or of means.

Single control chart. An out-of-control condition in the analytical system is signalled if any of the following occur.

- (i) The current plotting value falls outside the action limits.
- (ii) The current value and the previous plotting value fall outside the warning limits but within the actions limits.
- (iii) Nine successive plotting values fall on the same side of the mean line.

Two control charts. When two different control materials are used in each run, the respective control charts are considered simultaneously. This increases the chance of a type 1 error (rejection of a sound run) but decreases the chance of a type 2 error (acceptance of a flawed run). An out-of-control condition is indicated if any of the following occur.

- (i) At least one of the plotting values falls outside the action limits.
- (ii) Both of the plotting values are outside the warning limits.
- (iii) The current value and the previous plotting value on the same control chart both fall outside the warning limits.
- (iv) Both control charts simultaneously show that four successive plotting values on the same side of the mean line.

- (v) One of the charts shows nine successive plotting values falling on the same side of the mean line.

A more thorough treatment of the control chart can be obtained by the application of the full Westgard rules, illustrated in Figure 2.

COMPENDIUM OF INTERNATIONAL METHODS OF ANALYSIS –OIV
Harmonized guidelines for internal quality control in analytical
chemistry laboratories

The analytical chemist should respond to an out-of-control condition by cessation of analysis pending diagnostic tests and remedial action followed by rejection of the results of the run and reanalysis of the test materials.

4. REFERENCES

- 1 W A Shewhart, *"Economic control of quality in manufactured product"*, Van Nostrand, New York, 1931.
- 2 ISO 8258:1991. *"Shewhart control charts"*.
- 3 ISO 7873:1993 *"Control charts for arithmetic means with warning limits"*.
- 4 ISO 7870:1993. *"Control charts - general guide and introduction"*.
- 5 ISO 7966:1993. *"Acceptance control charts"*.
- 6 S Levey and E R Jennings, *Am. J. Clin. Pathol.*, 1950, **20**, 1059-1066.
- 7 A B J Nix, R J Rowlands, K W Kemp, D W Wilson and K Griffiths, *Stat. Med.*, 1987,**6**,425-440.
- 8 J O Westgard, P L Barry and M R Hunt, *Clin. Chem.*, 1981, **27**, 493-501.
- 9 C A Parvin, *Clin. Chem.*, 1992, **38**, 358-363.
- 10 J Bishop and A B J Nix, *Clin. Chem.*, 1993, **39**, 1638-1649.
- 11 W Horwitz, *Pure Appl. Chem.*, (in press).
- 12 Analytical Methods Committee, *Analyst*, 1989, **114**, 1693-1697.
- 13 Analytical Methods Committee, *Analyst*, 1989, **114**, 1699-1702.

Technical report from the Symposium on the 'Harmonisation of quality assurance systems for Analysis Laboratories, Washington DC, USA, 22-23 July 1993 sponsored by IUPAC, ISO et AOAC International

Prepared for publication by MICHAEL THOMPSON¹ and ROGER WOOD²

¹*Department of Chemistry, Birkbeck College (University of London), London WC1H 0PP, UK*

²*MAFF Food Science Laboratory, Norwich Research Park, Colney, Norwich NR4 7UQ, UK*

1991-95 work group :

Chairman : M. Parkany (Switzerland) ; Membres : T. Anglov (Denmark) ; K. Bergknut (Norway and Sweden) ; P. De Biève (Belgium) ; K.-G. von Boroviczény (Germany) ; J.M. Christensen (Denmark) ; T.D. Geary (South Australia) ; R. Greenhalgh (Canada) ; A.J. Head (United Kingdom) ; P.T. Holland (New Zealand) ; W. Horwitz (USA) ; A. Kallner (Sweden) ; J. Kristiansen (Denmark) ; S.H.H. Orlachs (Netherlands) ; N. Palmer (USA) ; M. Thompson (United Kingdom) ; M.J. Vernengo (Argentina) ; R. Wood (United Kingdom).

**Practical guide for the validation, quality control, and
uncertainty assessment of an alternative
oenological analysis method**
(Resolution 10/2005)

Contents

1. PURPOSE	5
2. PREAMBLE AND SCOPE	5
3. GENERAL VOCABULARY.....	6
4. GENERAL PRINCIPLES	12
4.1 METHODOLOGY	12
4.2 DEFINITION OF MEASUREMENT ERROR.....	13
5. VALIDATING A METHOD.....	14
5.1 METHODOLOGY.....	14
5.2 SECTION ONE: SCOPE OF METHOD	15
5.2.1 <i>Definition of analyzable matrices.....</i>	<i>15</i>
5.2.2 <i>Detection and quantification limit.....</i>	<i>15</i>
5.2.2.1 Normative definition.....	16
5.2.2.2 Reference documents	16
5.2.2.3 Application	16
5.2.2.4 Procedure.....	16
5.2.2.4.1 Determination on blank.....	16
5.2.2.4.1.1 Scope.....	16
5.2.2.4.1.2 Basic protocol and calculations.....	17
5.2.2.4.2 Approach by linearity study	18
5.2.2.4.2.1 Scope.....	18
5.2.2.4.2.2 Basic protocol and calculations.....	19
5.2.2.4.3 Graphic approach based on the background noise of the recording.....	21
5.2.2.4.3.1 Scope.....	21
5.2.2.4.3.2 Basic protocol and calculation.....	21
5.2.2.4.4 Checking a predetermined quantification limit	21
5.2.2.4.4.1 Scope.....	21
5.2.2.4.4.2 Basic protocol and calculation.....	22
5.2.3 <i>Robustness.....</i>	<i>24</i>
5.2.3.1 Definition.....	24
5.2.3.2 Determination	24
5.3 SECTION TWO: SYSTEMATIC ERROR STUDY.....	24
5.3.1 <i>Linearity study.....</i>	<i>24</i>
5.3.1.1 Normative definition.....	24
5.3.1.2 Reference documents	24
5.3.1.3 Application	24

COMPENDIUM OF INTERNATIONAL ANALYSIS OF METHODS - OIV
Guide for the validation – quality control

5.3.1.4	ISO 11095-type approach	25
5.3.1.4.1	Basic protocol	25
5.3.1.4.2	Calculations and results.....	26
5.3.1.4.2.1	Defining the regression model.....	26
5.3.1.4.2.2	Estimating parameters	27
5.3.1.4.2.3	Charts	27
5.3.1.4.2.4	Test of the linearity assumption.....	29
5.3.1.4.2.4.1	Definitions of errors linked to calibration.....	29
5.3.1.4.2.4.2	Fischer-Snedecor test.....	31
5.3.1.5	ISO 8466-type approach	32
5.3.1.5.1	Basic protocol	32
5.3.1.5.2	Calculations and results.....	33
5.3.1.5.2.1	Defining the linear regression model.....	33
5.3.1.5.2.2	Defining the polynomial regression model.....	33
5.3.1.5.2.3	Comparing residual standard deviations.....	34
5.3.2	<i>Specificity</i>	36
5.3.2.1	Normative definition.....	36
5.3.2.2	Application	36
5.3.2.3	Procedures	36
5.3.2.3.1	Standard addition test.....	36
5.3.2.3.1.1	Scope.....	36
5.3.2.3.1.2	Basic protocol.....	36
5.3.2.3.1.3	Calculations and results.....	37
5.3.2.3.1.3.1	Study of the regression line $r = a + b.v$	37
5.3.2.3.1.3.2	Analysis of the results.....	38
5.3.2.3.1.3.3	Overlap line graphics	40
5.3.2.3.2	Study of the influence of other compounds on the measurement result	40
5.3.2.3.2.1	Scope.....	40
5.3.2.3.2.2	Basic protocol and calculations	40
5.3.2.3.2.3	Interpretation	41
5.3.3	<i>Study of method accuracy</i>	43
5.3.3.1	Presentation of the step	43
5.3.3.1.1	Definition	43
5.3.3.1.2	General principles	43
5.3.3.1.3	Reference documents	43
5.3.3.2	Comparison of the alternative method with the OIV reference method.....	44
5.3.3.2.1	Scope.....	44
5.3.3.2.2	Accuracy of the alternative method compared with the reference method	44
5.3.3.2.2.1	Definition	44
5.3.3.2.2.2	Scope.....	44
5.3.3.2.2.3	Basic protocol and calculations	44
5.3.3.2.2.4	Interpretation	46
5.3.3.3	Comparison by interlaboratory tests	47
5.3.3.3.1	Scope.....	47
5.3.3.3.2	Basic protocol and calculations.....	48
5.3.3.3.3	Interpretation.....	49
5.3.3.4	Comparison with reference materials	50
5.3.3.4.1	Scope.....	50
5.3.3.4.2	Basic protocol and calculations.....	50
5.3.3.4.3	Interpretation.....	51
5.4	SECTION THREE: RANDOM ERROR STUDY.....	52
5.4.1	<i>General principle</i>	52

COMPENDIUM OF INTERNATIONAL ANALYSIS OF METHODS - OIV
Guide for the validation – quality control

5.4.2	<i>Reference documents</i>	53
5.4.3	<i>Precision of the method</i>	53
5.4.3.1	Definition.....	53
5.4.3.2	Scope.....	53
5.4.3.3	General theoretical case.....	54
5.4.3.3.1	Basic protocol and calculations.....	54
5.4.3.3.1.1	Calculations with several test materials.....	54
5.4.3.3.1.2	Calculations with 1 test material.....	56
5.4.3.4	Repeatability.....	57
5.4.3.4.1	Definitions.....	57
5.4.3.4.2	Scope.....	58
5.4.3.4.3	Basic protocol and calculations.....	58
5.4.3.4.3.1	General case.....	58
5.4.3.4.3.2	Particular case applicable to only 1 repetition.....	58
5.4.3.4.4	Comparison of repeatability.....	60
5.4.3.4.4.1	Determination of the repeatability of each method.....	60
5.4.3.4.4.2	Fischer-Snedecor test.....	61
5.4.3.5	Intralaboratory reproducibility.....	62
5.4.3.5.1	Definition.....	62
5.4.3.5.2	Scope.....	62
5.4.3.5.3	Basic protocol and calculations.....	62
6.	QUALITY CONTROL OF ANALYSIS METHODS (IQC).....	64
6.1	REFERENCE DOCUMENTS.....	64
6.2	GENERAL PRINCIPLES.....	64
6.3	REFERENCE MATERIALS.....	64
6.4	CHECKING THE ANALYTICAL SERIES.....	66
6.4.1	<i>Definition</i>	66
6.4.2	<i>Checking accuracy using reference materials</i>	66
6.4.3	<i>Intraseries precision</i>	66
6.4.4	<i>Internal standard</i>	67
6.5	CHECKING THE ANALYSIS SYSTEM.....	67
6.5.1	<i>Definition</i>	67
6.5.2	<i>Shewhart chart</i>	67
6.5.2.1	Data acquisition.....	67
6.5.2.2	Presentation of results and definition of limits.....	68
6.5.2.3	Using the Shewhart chart.....	69
6.5.3	<i>Internal comparison of analysis systems</i>	70
6.5.4	<i>External comparison of the analysis system</i>	70
6.5.4.1	Analysis chain of interlaboratory comparisons.....	70
6.5.4.2	Comparison with external reference materials.....	70
6.5.4.2.1	Standard uncertainty of reference material.....	71
6.5.4.2.2	Defining the validity limits of measuring reference material.....	71
7.	ASSESSMENT OF MEASUREMENT UNCERTAINTY.....	72
7.1	DEFINITION.....	72
7.2	REFERENCE DOCUMENTS.....	73
7.3	SCOPE.....	73
7.4	METHODOLOGY.....	74

COMPENDIUM OF INTERNATIONAL ANALYSIS OF METHODS - OIV
Guide for the validation – quality control

7.4.1	<i>Definition of the measurand, and description of the quantitative analysis method</i>	74
7.4.2	<i>Critical analysis of the measurement process</i>	75
7.4.3	<i>Estimation calculations of standard uncertainty (intralaboratory approach)</i>	75
7.4.3.1	Principle.....	75
7.4.3.2	Calculating the standard deviation of intralaboratory reproducibility.....	78
7.4.3.3	Estimating typical sources of systematic errors not taken into account under μ reproducibility conditions	79
7.4.3.3.1	Gauging error (or calibration error).....	79
7.4.3.3.1.1	Procedure.....	79
7.4.3.3.1.2	Calculations and results.....	80
7.4.3.3.1.3	Estimating the standard uncertainty associated the gauging line (or calibration line).....	81
7.4.3.3.2	Bias error.....	82
7.4.3.3.2.1	Methods adjusted with only one certified reference material	82
7.4.3.3.2.2	Methods adjusted with several reference materials (gauging ranges etc).....	82
7.4.3.3.3	Matrix effect.....	83
7.4.3.3.3.1	Definition	83
7.4.3.3.4	Sample effect.....	86
7.4.4	<i>Estimating standard uncertainty by interlaboratory tests</i>	86
7.4.4.1	Principle.....	86
7.4.4.2	Using the standard deviation of interlaboratory and intramethod reproducibility SR_{inter} (method).....	87
7.4.4.3	Using the standard deviation of interlaboratory and intermethod reproducibility SR_{inter}	87
7.4.4.4	Other components in the uncertainty budget.....	88
7.5	EXPRESSING EXPANDED UNCERTAINTY	88

1. Purpose

The purpose of this guide is to assist oenological laboratories carrying out serial analysis as part of their validation, internal quality control and uncertainty assessment initiatives concerning the standard methods they use.

2. Preamble and scope

International standard ISO 17025, defining the "General Requirements for the Competence of Testing and Calibration Laboratories", states that the accredited laboratories must, when implementing an alternative analytical method, make sure of the quality of the results obtained. To do so, it indicates several steps. The first step consists in defining the customers' requirements concerning the parameter in question, in order to determine, thereafter, whether the method used meets those requirements. The second step includes initial validation for non-standardized, modified or laboratory-developed methods. Once the method is applied, the laboratories must use inspection and traceability methods in order to monitor the quality of the results obtained. Finally, they must assess the uncertainty of the results obtained.

In order to meet these requirements, the laboratories have a significant reference system at their disposal comprising a large number of international guides and standards. However, in practice, the application of these texts is delicate since, because they address every category of calibration and test laboratory, they remain very general and presuppose, on behalf of the reader, in-depth knowledge of the mathematical rules applicable to statistical data processing.

This guide is based on this international reference system, taking into account the specific characteristics of oenology laboratories routinely carrying out analyses on series of must or wine samples. Defining the scope of application in this way enabled a relevant choice of suitable tools to be made, in order to retain only those methods most suitable for that scope. Since it is based on the international reference system, this guide is therefore strictly compliant with it. Readers, however, wishing to study certain points of the guide in greater detail can do so by referring to the international standards and guides, the references for which are given in each chapter.

The authors have chosen to combine the various tools meeting the requirements of the ISO 17025 standard since there is an obvious solution of continuity in their

application, and the data obtained with certain tools can often be used with the others. In addition, the mathematical resources used are often similar.

The various chapters include application examples, taken from oenology laboratories using these tools.

It is important to point out that that this guide does not pretend to be exhaustive. It is only designed to present, in as clear and applicable a way as possible, the contents of the requirements of the ISO 17025 standard and the basic resources that can be implemented in a routine laboratory to meet them. Each laboratory remains perfectly free to supplement these tools or to replace them by others that they consider to be more efficient or more suitable.

Finally, the reader's attention should be drawn to the fact that the tools presented do not constitute an end in themselves and that their use, as well as the interpretation of the results to which they lead, must always be subject to critical analysis. It is only under these conditions that their relevance can be guaranteed, and laboratories will be able to use them as tools to improve the quality of the analyses they carry out.

3. General vocabulary

The definitions indicated below used in this document result from the normative references given in the bibliography.

Analyte

Object of the analysis method

Blank

Test carried out in the absence of a matrix (reagent blank) or on a matrix which does not contain the analyte (matrix blank).

Bias

Difference between the expected test results and an accepted reference value.

Uncertainty budget

The list of uncertainty sources and their associated standard uncertainties, established in order to assess the compound standard uncertainty associated with a measurement result.

Gauging (of a measuring instrument)

Material positioning of each reference mark (or certain principal reference marks only) of a measuring instrument according to the corresponding value of the measurand.

NOTE "gauging" and "calibration" are not be confused

Repeatability conditions

Conditions where independent test results are obtained with the same method on identical test items in the same laboratory by the same operator using the same equipment within short intervals of time.

Reproducibility conditions (intralaboratory)

Conditions where independent test results are obtained with the same method on identical test items in the same laboratory by the same or different operator(s) using different gauges on different days.

Experimental standard deviation

For a series of n measurements of the same measurand, the quantity s characterizing the dispersion of the results and given by the formula:

$$s = \sqrt{\frac{\sum_{i=1}^n (x_i - \bar{x})^2}{n - 1}}$$

x_i being the result of the measurement i^{th} and \bar{x} the arithmetic mean of the n results considered.

Repeatability standard deviation

Standard deviation of many repetitions obtained in a single laboratory by the same operator on the same instrument, i.e. under repeatable conditions.

Internal reproducibility standard deviation (or total intralaboratory variability)

Standard deviation of repetitions obtained in a single laboratory with the same method, using several operators or instruments and, in particular, by taking measurements on different dates, i.e. under reproducibility conditions.

Random error

Result of a measurement minus the mean that would result from an infinite number of measurements of the same measurand carried out under reproducibility conditions.

Measurement error

Result of a measurement minus a true value of the measurand.

Systematic error

Mean error that would result from an infinite number of measurements of the same measurand carried out under reproducibility conditions minus a true value of the measurand.

NOTE Error is a highly theoretical concept in that it calls upon values that are not accessible in practice, in particular the true values of measurands. On principle, the error is unknown.

Mathematical expectation

For a series of n measurements of the same measurand, if n tends towards the infinite, the mean \bar{x} tends towards the expectation $E(x)$.

$$E(x) = n \lim_{n \rightarrow \infty} \frac{\sum_{i=1}^n x_i}{n}$$

Calibration

Series of operations establishing under specified conditions the relation between the values of the quantity indicated by a measuring instrument or system, or the values represented by a materialized measurement or a reference material, and the corresponding values of the quantity measured by standards.

Intralaboratory evaluation of an analysis method

Action which consists in submitting an analysis method to an intralaboratory statistical study, based on a standardized and/or recognized protocol, demonstrating that within its scope, the analysis method meets pre-established performance criteria.

Within the framework of this document, the evaluation of a method is based on an intralaboratory study, which includes the comparison with a reference method.

Precision

Closeness of agreement between independent test results obtained under prescribed conditions

NOTE 1 Precision depends only on the distribution of random errors and does not have any relationship with the true or specified value.

NOTE 2 The measurement of precision is expressed on the basis of the standard deviation of the test results.

NOTE 3 The expression "independent test results" refers to results obtained such that they are not influenced by a previous result on the same or a similar test

material. Quantitative measurements of precision are critically dependent upon the prescribed conditions. Repeatability and reproducibility conditions are particular sets of extreme conditions.

Quantity (measurable)

An attribute of a phenomenon, body or substance that may be distinguished qualitatively and determined quantitatively.

Uncertainty of measurement

A parameter associated with the result of a measurement, which characterizes the dispersion of the values that could reasonably be attributed to the measurand.

Standard uncertainty ($u(x_i)$)

Uncertainty of the result of a measurement expressed in the form of a standard deviation.

Accuracy

Closeness of agreement between the mean value obtained starting from a broad series of test results and an accepted reference value.

NOTE The measurement of accuracy is generally expressed in terms of bias.

Detection limit

Lowest amount of an analyte to be examined in a test material that can be detected and regarded as different from the blank value (with a given probability), but not necessarily quantified. In fact, two risks must be taken into account:

- the risk α of considering the substance is present in test material when its quantity is null;
- the risk β of considering a substance is absent from a substance when its quantity is not null.

Quantification limit

Lowest amount of an analyte to be examined in a test material that can be quantitatively determined under the experimental conditions described in the method with a defined variability (given coefficient of variation).

Linearity

The ability of a method of analysis, within a certain range, to provide an instrumental response or results proportional to the quantity of analyte to be determined in the laboratory sample.

This proportionality is expressed by an a priori defined mathematical expression.

The linearity limits are the experimental limits of concentrations between which a linear calibration model can be applied with a known confidence level (generally taken to be equal to 1%).

Test material

Material or substance to which a measuring can be applied with the analysis method under consideration.

Reference material

Material or substance one or more of whose property values are sufficiently homogeneous and well established to be used for the calibration of an apparatus, the assessment of a measurement method, or for assigning values to materials.

Certified reference material

Reference material, accompanied by a certificate, one or more whose property values are certified by a procedure which establishes its traceability to an accurate realization of the unit in which the property values are expressed, and for which each certified value is accompanied by an uncertainty at a stated level of confidence.

Matrix

All the constituents of the test material other than the analyte.

Analysis method

Written procedure describing all the means and procedures required to carry out the analysis of the analyte, i.e.: scope, principle and/or reactions, definitions, reagents, apparatus, procedures, expression of results, precision, test report.

WARNING The expressions "titration method" and "determination method" are sometimes used as synonyms for the expression "analysis method". These two expressions should not be used in this way.

Quantitative analysis method

Analysis method making it possible to measure the analyte quantity present in the laboratory test material.

Reference analysis method (Type I or Type II methods)

Method, which gives the accepted reference value for the quantity of the analyte to be measured.

Non-classified alternative method of analysis

A routine analysis method used by the laboratory and not considered to be a reference method.

NOTE An alternative method of analysis can consist in a simplified version of the reference method.

Measurement

Set of operations having the object of determining a value of a quantity.

NOTE The operations can be carried out automatically.

Measurand

Particular quantity subject to measurement.

Mean

For a series of *n* measurements of the same measurand, mean value, given by the formula:

$$\bar{x} = \frac{\sum_{i=1}^n x_i}{n}$$

x_i being the result of the *ith* measurement.

Result of a measurement

Value assigned to a measurand, obtained by measurement

Sensitivity

Ratio between the variation of the information value of the analysis method and the variation of the analyte quantity.

The variation of the analyte quantity is generally obtained by preparing various standard solutions, or by adding the analyte to a matrix.

NOTE 1 Defining, by extension, the sensitivity of a method as its capacity to detect small quantities should be avoided.

NOTE 2 A method is said to be “sensitive” if a low variation of the quantity or analyte quantity incurs a significant variation in the information value.

Measurement signal

Quantity representing the measurand and is functionally linked to it.

Specificity

Property of an analysis method to respond exclusively to the determination of the quantity of the analyte considered, with the guarantee that the measured signal comes only from the analyte.

Tolerance

Deviation from the reference value, as defined by the laboratory for a given level, within which a measured value of a reference material can be accepted.

Value of a quantity

Magnitude of a particular quantity generally expressed as a unit of measurement multiplied by a number.

True value of a quantity

Value compatible with the definition of a given particular quantity.

NOTE 1 The value that would be obtained if the measurement was perfect

NOTE 2 Any true value is by nature indeterminate

Accepted reference value

A value that serves as an agreed-upon reference for comparison and which is derived as:

- a) a theoretical or established value, based on scientific principles;
- b) an assigned or certified value, based on experimental work of some national or international organization;
- c) a consensus or certified value, based on collaborative experimental work under the auspices of a scientific or engineering group;

Within the particular framework of this document, the accepted reference value (or conventionally true value) of the test material is given by the arithmetic mean of the values of measurements repeated as per the reference method.

Variance

Square of the standard deviation.

4. General principles

4.1 Methodology

When developing a new alternative method, the laboratory implements a protocol that includes several steps. The first step, applied only once at the initial stage, or on a regular basis, is the validation of the method. This step is followed by permanent quality control. All the data collected during these two steps make it possible to assess the quality of the method. **The data collected during these two**

steps are used to evaluate the measurement uncertainty. The latter, which is regularly assessed, is an indicator of the quality of the results obtained by the method under consideration.

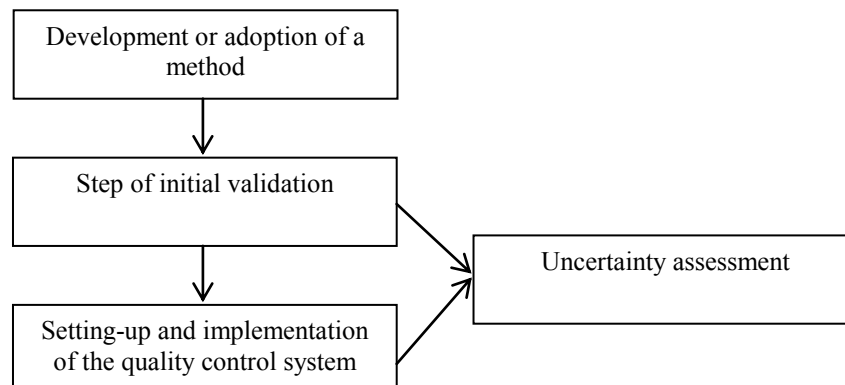

All these steps are inter-connected and constitute a global approach that can be used to assess and control measurement errors.

4.2 Definition of measurement error

Any measurement carried out using the method under study gives a result which is inevitably associated with a measurement error, defined as being the difference between the result obtained and the true value of the measurand. In practice, **the true value of the measurand is inaccessible** and a value conventionally accepted as such is used instead.

The measurement error includes two components:

$$\text{True value} = \text{Analysis result} + \underbrace{\text{Systematic error} + \text{Random error}}_{\text{Measurement error}}$$

In practice, the systematic error results in a bias in relation to the true value, the random error being all the errors associated with the application of the method.

These errors can be graphically represented in the following way:

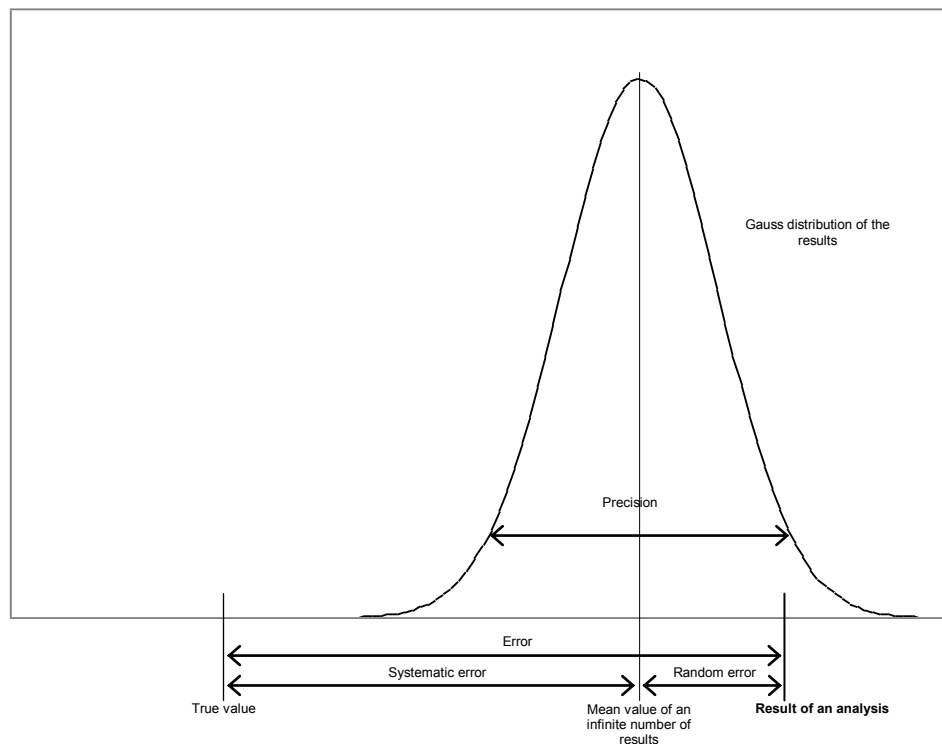

The validation and quality control tools are used to evaluate the systematic errors and the random errors, and to monitor their changes over time.

5. Validating a method

5.1 Methodology

Implementing the validation comprises 3 steps, each with objectives. To meet these objectives, the laboratory has validation tools. Sometimes there are many tools for a given objective, and are suitable for various situations. It is up to the laboratory to correctly choose the most suitable tools for the method to be validated.

<u>Steps</u>	<u>Objectives</u>	<u>Tools for validation</u>
Scope of application	<ul style="list-style-type: none"> - To define the analyzable matrices - To define the analyzable range 	<ul style="list-style-type: none"> Detection and quantification limit Robustness study
Systematic error or bias	<ul style="list-style-type: none"> - Linear response in the scale of analyzable values - Specificity of the method - Accuracy of the method 	<ul style="list-style-type: none"> Linearity study Specificity study Comparison with a reference method Comparison with reference materials Interlaboratory comparison
Random error	<ul style="list-style-type: none"> - Precision of the method 	<ul style="list-style-type: none"> Repeatability study Intralaboratory reproducibility study

5.2 Section one: Scope of method

5.2.1 Definition of analyzable matrices

The matrix comprises all constituents in the test material other than the analyte. If these constituents are liable to influence the result of a measurement, the laboratory should define the matrices on which the method is applicable.

For example, in oenology, the determination of certain parameters can be influenced by the various possible matrices (wines, musts, sweet wines, etc.).

In case of doubt about a matrix effect, more in-depth studies can be carried out as part of the specificity study.

5.2.2 Detection and quantification limit

This step is of course not applicable and not necessary for those methods whose lower limit does not tend towards 0, such as alcoholic strength by volume in wines, total acidity in wines, pH, etc.

5.2.2.1 Normative definition

The detection limit is the lowest amount of analyte that can be detected but not necessarily quantified as an exact value. The detection limit is a parameter of limit tests.

The quantification limit is the lowest quantity of the compound that can be determined using the method.

5.2.2.2 Reference documents

- NF V03-110 Standard, intralaboratory validation procedure for an alternative method in relation to a reference method.
- International compendium of analysis methods – OIV, Assessment of the detection and quantification limit of an analysis method (Oeno resolution 7/2000).

5.2.2.3 Application

In practice, the quantification limit is generally more relevant than the detection limit, the latter being by convention 1/3 of the first.

There are several approaches for assessing the detection and quantification limits:

- Determination on blank
- Approach by the linearity study
- Graphic approach

These methods are suitable for various situations, but in every case they are mathematical approaches giving results of informative value only. It seems crucial, whenever possible, to introduce a check of the value obtained, whether by one of these approaches or estimated empirically, using the checking protocol for a predetermined quantification limit.

5.2.2.4 Procedure

5.2.2.4.1 Determination on blank

5.2.2.4.1.1 Scope

This method can be applied when the blank analysis gives results with a non-zero standard deviation. The operator will judge the advisability of using reagent blanks, or matrix blanks.

If the blank, for reasons related to uncontrolled signal preprocessing, is sometimes not measurable or does not offer a recordable variation (standard deviation of 0), the operation can be carried out on a very low concentration in analyte, close to the blank.

5.2.2.4.1.2 Basic protocol and calculations

Carry out the analysis of n test materials assimilated to blanks, n being equal to or higher than 10.

- Calculate the mean of the x_i results obtained:

$$\bar{x}_{blank} = \frac{\sum_{i=1}^n x_i}{n}$$

- Calculate the standard deviation of the x_i results obtained:

$$S_{blank} = \sqrt{\frac{\sum_{i=1}^n (x_i - \bar{x}_{blank})^2}{n-1}}$$

- From these results the detection limit is conventionally defined by the formula:

$$L_d = \bar{x}_{blank} + (3 \cdot S_{blank})$$

- From these results the quantification limit is conventionally defined by the formula:

$$L_q = \bar{x}_{blank} + (10 \cdot S_{blank})$$

Example: *The table below gives some of the results obtained when assessing the detection limit for the usual determination of free sulfur dioxide.*

<i>Test material #</i>	<i>X</i> <i>(mg/l)</i>
1	0
2	1
3	0
4	1.5
5	0
6	1
7	0.5
8	0
9	0
10	0.5
11	0
12	0

The calculated values are as follows:

$$q = 12$$

$$M_{blank} = 0.375$$

$$S_{blank} = 0.528 \text{ mg/l}$$

$$DL = 1.96 \text{ mg/l}$$

$$QL = 5.65 \text{ mg/l}$$

5.2.2.4.2 Approach by linearity study

5.2.2.4.2.1 Scope

This method can be applied in all cases, and is required when the analysis method does not involve background noise. It uses the data calculated during the linearity study.

NOTE This statistical approach may be biased and give pessimistic results when linearity is calculated on a very wide range of values for reference materials, and whose measurement results include variable standard deviations. In such cases, a linearity study limited to a range of low values, close to 0 and with a more homogeneous distribution will result in a more relevant assessment.

5.2.2.4.2.2 Basic protocol and calculations

Use the results obtained during the linearity study which made it possible to calculate the parameters of the calibration function $y = a + b \cdot x$

The data to be recovered from the linearity study are (see chapter 5.3.1. linearity study):

- slope of the regression line:

$$b = \frac{\sum_{i=1}^n (x_i - M_x)(y_i - M_y)}{\sum_{i=1}^n (x_i - M_x)^2}$$

- residual standard deviation:

$$S_{res} = \sqrt{\frac{\sum_{i=1}^n \sum_{j=1}^p (y_{i,j} - \hat{y}_{i,j})^2}{pn - 2}}$$

- standard deviation at the intercept point (to be calculated):

$$S_a = S_{res} \sqrt{\left(\frac{1}{np} + \frac{M_x^2}{\sum_{i=1}^n p(x_i - M_x)^2} \right)}$$

The estimates of the detection limit **DL** and the quantification limit **QL** are calculated using following formulae:

$$DL = \frac{3 \times S_a}{b} \quad \text{Estimated detection limit}$$

$$QL = \frac{10 \times S_a}{b} \quad \text{Estimated quantification limit}$$

COMPENDIUM OF INTERNATIONAL ANALYSIS OF METHODS - OIV
Guide for the validation – quality control

Example: Estimation of the detection and quantification limits in the determination of sorbic acid by capillary electrophoresis, based on linearity data acquired on a range from 1 to 20 mg.L⁻¹.

X (ref)	Y1	Y2	Y3	Y4
1	1.9	0.8	0.5	1.5
2	2.4	2	2.5	2.1
3	4	2.8	3.5	4
4	5.3	4.5	4.7	4.5
5	5.3	5.3	5.2	5.3
10	11.6	10.88	12.1	10.5
15	16	15.2	15.5	16.1
20	19.7	20.4	19.5	20.1

Number of reference materials

$$n = 8$$

Number of replicas

$$p = 4$$

Straight line ($y = a + b \cdot x$)

$$b = 0.9972$$

$$a = 0.51102$$

residual standard deviation:

$$S_{res} = 0.588$$

Standard deviation on the intercept
point

$$S_a = 0.1597$$

The estimated detection limit is $DL = 0.48 \text{ mg.L}^{-1}$
The estimated quantification limit is $QL = 1.6 \text{ mg.L}^{-1}$

5.2.2.4.3 Graphic approach based on the background noise of the recording

5.2.2.4.3.1 Scope

This approach can be applied to analysis methods that provide a graphic recording (chromatography, etc.) with a background noise. The limits are estimated from a study of the background noise.

5.2.2.4.3.2 Basic protocol and calculation

Record a certain number of reagent blanks, using 3 series of 3 injections separated by several days.

Determine the following values:

- h_{\max} the greatest variation in amplitude on the y-axis of the signal observed between two acquisition points, excluding drift, at a distance equal to twenty times the width at mid-height of the peak corresponding to the analyte, centered over the retention time of the compound under study.
- R, the quantity/signal response factor, expressed in height.

The detection limit **DL**, and the quantification limit **QL** are calculated according to the following formulae:

$$DL = 3 h_{\max} R \qquad QL = 10 h_{\max} R$$

5.2.2.4.4 Checking a predetermined quantification limit

This approach can be used to validate a quantification value obtained by statistical or empirical approach.

5.2.2.4.4.1 Scope

This method can be used to check that a given quantification limit is *a priori* acceptable. It is applicable when the laboratory can procure at least 10 test materials with known quantities of analyte, at the level of the estimated quantification limit.

In the case of methods with a specific signal, not sensitive to matrix effects, the materials can be synthetic solutions whose reference value is obtained by formulation.

In all other cases, wines (or musts) shall be used whose measurand value as obtained by the reference method is equal to the limit to be studied. Of course, in this case the quantification limit of the reference method must be lower than this value.

5.2.2.4.4.2 *Basic protocol and calculation*

Analyze n independent test materials whose accepted value is equal to the quantification limit to be checked; n must at least be equal to 10.

- Calculate the mean of n measurements:

$$\bar{x}_{LQ} = \frac{\sum_{i=1}^n x_i}{n}$$

- Calculate the standard deviation of n measurements:

$$S_{LQ} = \sqrt{\frac{\sum_{i=1}^n (x_i - \bar{x}_{LQ})^2}{n-1}}$$

with x_i results of the measurement of the i^{th} test material.

The two following conditions must be met:

a) the measured mean quantity \bar{x}_{LQ} must not be different from the predetermined quantification limit QL :

If $\frac{|QL - \bar{x}_{LQ}|}{\frac{S_{QL}}{\sqrt{n}}} < 10$ then quantification limit QL is considered to be valid.

$$\frac{S_{QL}}{\sqrt{n}}$$

NOTE 10 is a purely conventional value relating to the QL criterion.

b) the quantification limit must be other than 0:

If $5 S_{QL} < QL$ then the quantification limit is other than 0.

A value of 5 corresponds to an approximate value for the spread of the standard deviation, taking into account risk α and risk β to ensure that the QL is other than 0.

This is equivalent to checking that the coefficient of variation for QL is lower than 20%.

NOTE1 Remember that the detection limit is obtained by dividing the quantification limit by 3.

NOTE2 A check should be made to ensure that the value of S_{LQ} is not too large (which would produce an artificially positive test), and effectively corresponds to a reasonable standard deviation of the variability of the results for the level under consideration. It is up to the laboratory to make this critical evaluation of the value of S_{LQ} .

Example: Checking the quantification limit of the determination of malic acid by the enzymatic method.

Estimated quantification limit: 0.1 g.L^{-1}

Wine	Values
1	0.1
2	0.1
3	0.09
4	0.1
5	0.09
6	0.08
7	0.08
8	0.09
9	0.09
10	0.08

Mean: 0.090

Standard deviation: 0.008

First condition: $\frac{|LQ - \bar{x}_{QL}|}{\frac{S_{QL}}{\sqrt{n}}} = 3.87 < 10$ The quantification

limit of 0.1 is considered to be valid.

Second condition: $5 \cdot S_{LQ} = 0.04 < 0.1$ The quantification limit is considered to be significantly different from 0.

5.2.3 *Robustness*

5.2.3.1 *Definition*

Robustness is the capacity of a method to give close results in the presence of slight changes in the experimental conditions likely to occur during the use of the procedure.

5.2.3.2 *Determination*

If there is any doubt about the influence of the variation of operational parameters, the laboratory can use the scientific application of experiment schedules, enabling these critical operating parameters to be tested within the variation range likely to occur under practical conditions. In practice, these tests are difficult to implement.

5.3 Section two: systematic error study

5.3.1 *Linearity study*

5.3.1.1 *Normative definition*

The linearity of a method is its ability (within a given range) to provide an informative value or results proportional to the amount of analyte to be determined in the test material.

5.3.1.2 *Reference documents*

- NF V03-110 standard. Intralaboratory validation procedure of an alternative method in relation to a reference method.
- ISO 11095 Standard, linear calibration using reference materials.
- ISO 8466-1 Standard, Water quality – Calibration and evaluation of analytical methods and estimation of performance characteristics

5.3.1.3 *Application*

The linearity study can be used to define and validate a linear dynamic range.

This study is possible when the laboratory has stable reference materials whose accepted values have been acquired with certainty (in theory these values should have an uncertainty equal to 0). These could therefore be internal reference materials titrated with calibrated material, wines or musts whose value is given by

the mean of at least 3 repetitions of the reference method, external reference materials or certified external reference materials.

In the last case, and only in this case, this study also enables the traceability of the method. The experiment schedule used here could then be considered as a calibration.

In all cases, it is advisable to ensure that the matrix of the reference material is compatible with the method.

Lastly, calculations must be made with the final result of the measurement and not with the value of the signal.

Two approaches are proposed here:

- An ISO 11095 type of approach, the principle of which consists in comparing the residual error with the experimental error using a Fischer's test. This approach is valid above all for relatively narrow ranges (in which the measurand does not vary by more than a factor 10). In addition, under experimental conditions generating a low reproducibility error, the test becomes excessively severe. On the other hand, in the case of poor experimental conditions, the test will easily be positive and will also lose its relevance. This approach requires good homogeneity of the number of measurements over the entire range studied.
- An ISO 8466 type of approach, the principle of which consists in comparing the residual error caused by the linear regression with the residual error produced by a polynomial regression (of order 2 for example) applied to the same data. If the polynomial model gives a significantly lower residual error, a conclusion of nonlinearity could be drawn. This approach is appropriate in particular when there is a risk of high experimental dispersion at one end of the range. It is therefore naturally well-suited to analysis methods for traces. There is no need to work with a homogeneous number of measurements over the whole range, and it is even recommended to increase the number of measurements at the borders of the range.

5.3.1.4 ISO 11095-type approach

5.3.1.4.1 Basic protocol

It is advisable to use a number *n* of reference materials. The number must be higher than 3, but there is no need, however, to exceed 10. The reference materials

should be measured p times, under **reproducibility conditions**, p shall be higher than 3, a number of 5 being generally recommended. The accepted values for the reference materials are to be regularly distributed over the studied range of values. The number of measurements must be identical for all the reference materials.

NOTE It is essential that the reproducibility conditions use a maximum of potential sources of variability, with the risk that the test shows non-linearity in an excessive way.

The results are reported in a table presented as follows:

Reference materials	Accepted reference value material	Measured values				
		Replica 1	...	Replica j	...	Replica p
1	x_1	y_{11}	...	y_{1j}	...	y_{1p}
...
i	x_i	y_{i1}	...	y_{ij}	...	y_{ip}
...
n	x_n	y_{n1}	...	y_{nj}	...	y_{np}

5.3.1.4.2 Calculations and results

5.3.1.4.2.1 Defining the regression model

The model to be calculated and tested is as follows:

$$y_{ij} = a + b.x_i + \varepsilon_{ij}$$

where

y_{ij} is the j^{th} replica of the i^{th} reference material.

x_i is the accepted value of the i^{th} reference material.

b is the slope of the regression line.

a is the intercept point of the regression line.

$a+b.x_i$ represents the expectation of the measurement value of the i^{th} reference material.

ε_{ij} is the difference between y_{ij} and the expectation of the measurement value of the i^{th} reference material.

5.3.1.4.2.2 Estimating parameters

The parameters of the regression line are obtained using the following formulae:

- mean of p measurements of the i^{th} reference material

$$y_i = \frac{1}{p} \sum_{j=1}^p y_{ij}$$

- mean of all the accepted values of n reference materials

$$M_x = \frac{1}{n} \sum_{i=1}^n x_i$$

- mean of all the measurements

$$M_y = \frac{1}{n} \sum_{i=1}^n y_i$$

- estimated slope b

$$b = \frac{\sum_{i=1}^n (x_i - M_x)(y_i - M_y)}{\sum_{i=1}^n (x_i - M_x)^2}$$

- estimated intercept point a

$$a = M_y - b \times M_x$$

- regression value associated with the i^{th} reference material \hat{y}_i

$$\hat{y}_i = a + b \times x_i$$

- residual e_{ij}

$$e_{ij} = y_{ij} - \hat{y}_i$$

5.3.1.4.2.3 Charts

The results can be presented and analyzed in graphic form. Two types of charts are used.

- The first type of graph is the representation of the values measured against the accepted values of reference materials. The calculated overlap line is also plotted.

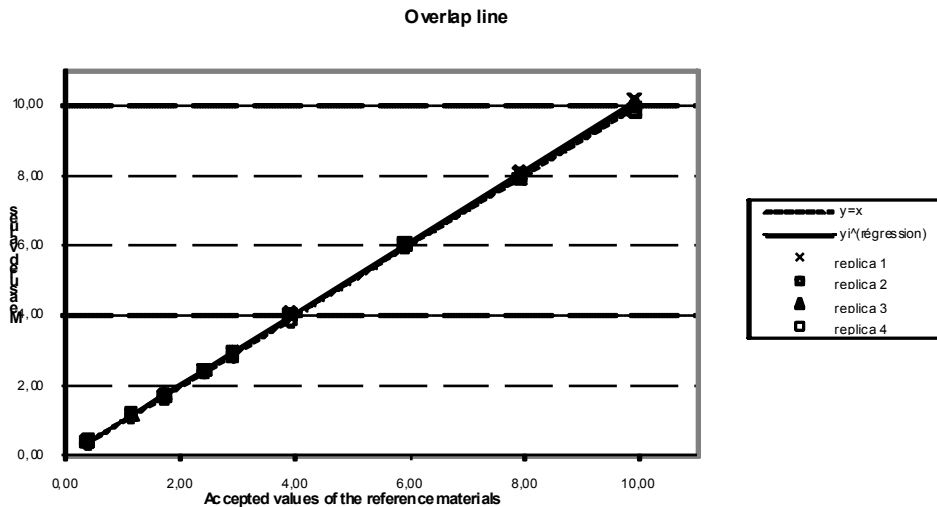

- The second graph is the representation of the residual values against the estimated values of the reference materials (\hat{y}) indicated by the overlap line.

The graph is a good indicator of the deviation in relation to the linearity assumption: the linear dynamic range is valid if the residual values are fairly distributed between the positive and negative values.

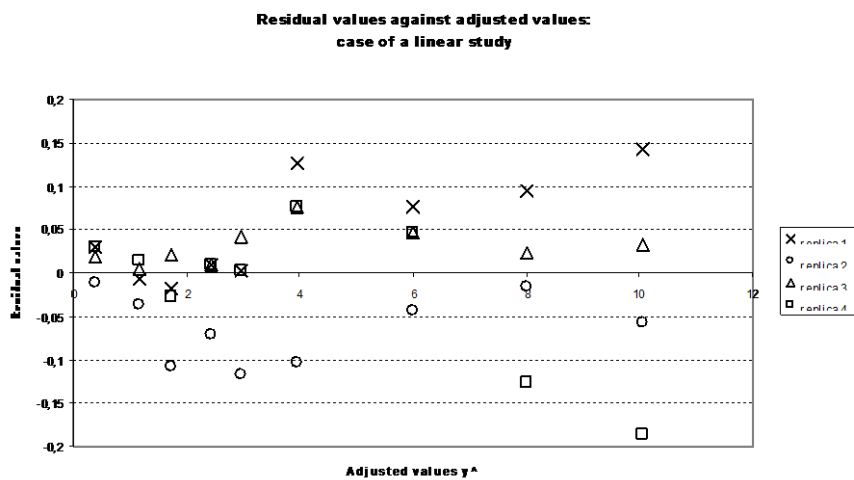

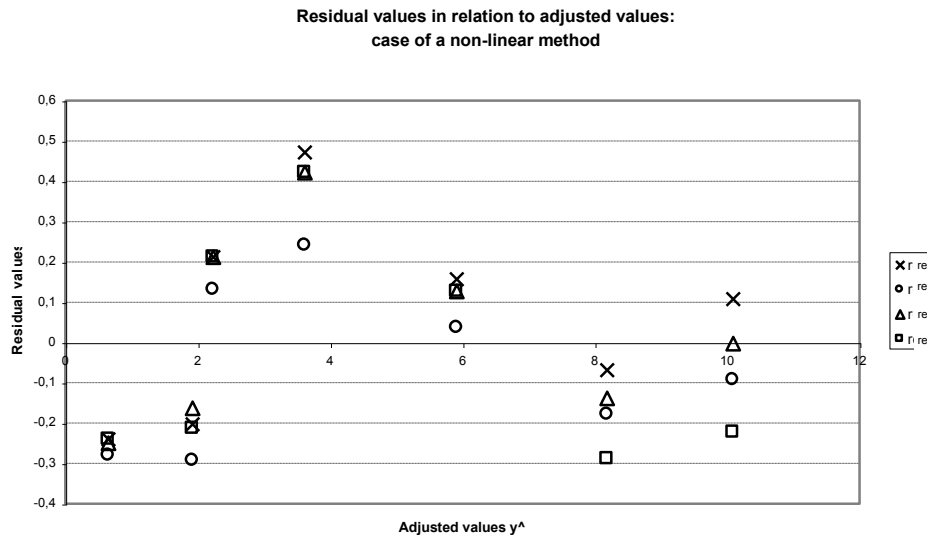

In case of doubt about the linearity of the regression, a Fischer-Snedecor test can be carried out in order to test the assumption: "the linear dynamic range is not valid", in addition to the graphic analysis.

5.3.1.4.2.4 Test of the linearity assumption

Several error values linked to calibration should be defined first of all: these can be estimated using the data collected during the experiment. A statistical test is then performed on the basis of these results, making it possible to test the assumption of non-validity of the linear dynamic range: this is the Fischer-Snedecor test.

5.3.1.4.2.4.1 Definitions of errors linked to calibration

These errors are given as a standard deviation, resulting from the square root of the ratio between a sum of squares and a degree of freedom.

Residual error

The residual error corresponds to the error between the measured values and the value given by the regression line.

The sum of the squares of the residual error is as follows:

$$Q_{res} = \sum_{i=1}^n \sum_{j=1}^p (y_{ij} - \hat{y}_i)^2$$

The number of degrees of freedom is $np-2$.

The residual standard deviation is then estimated by the formula:

$$S_{res} = \sqrt{\frac{\sum_{i=1}^n \sum_{j=1}^p (y_{ij} - \hat{y}_i)^2}{np-2}}$$

Experimental error

The experimental error corresponds to the reproducibility standard deviation of the experimentation.

The sum of the squares of the experimental error is as follows:

$$Q_{exp} = \sum_{i=1}^n \sum_{j=1}^p (y_{ij} - y_i)^2$$

The number of degrees of freedom is $np-n$.

The experimental standard deviation (reproducibility) is then estimated by the formula:

$$S_{exp} = \sqrt{\frac{\sum_{i=1}^n \sum_{j=1}^p (y_{ij} - y_i)^2}{np-n}}$$

NOTE This quantity is sometimes also noted S_R .

Adjustment error

The value of the adjustment error is the experimental error minus the residual error.

The sum of the squares of the adjustment error is:

$$Q_{def} = Q_{res} - Q_{exp}$$

or

$$Q_{def} = \sum_{i=1}^n \sum_{j=1}^p (y_{ij} - \hat{y}_i)^2 - \sum_{i=1}^n \sum_{j=1}^p (y_{ij} - y_i)^2$$

The number of degrees of freedom is $n-2$

The standard deviation of the adjustment error is estimated by the formula:

$$S_{def} = \sqrt{\frac{Q_{res} - Q_{exp}}{n - 2}}$$

or

$$S_{def} = \sqrt{\frac{\sum_{i=1}^n \sum_{j=1}^p (y_{ij} - \hat{y}_i)^2 - \sum_{i=1}^n \sum_{j=1}^p (y_{ij} - \bar{y}_i)^2}{n - 2}}$$

5.3.1.4.2.4.2 Fischer-Snedecor test

The ratio $F_{obs} = \frac{S_{def}^2}{S_{exp}^2}$ obeys the Fischer-Snedecor law with the degrees of freedom $n-2$, $np-n$.

The calculated experimental value F_{obs} is compared with the limit value: $F_{1-\alpha}(n-2, np-n)$, extracted from the Snedecor law table. The value for α used in practice is generally 5%.

If $F_{obs} \geq F_{1-\alpha}$ the assumption of the non-validity of the linear dynamic range is accepted (*with a risk of α error of 5%*).

If $F_{obs} < F_{1-\alpha}$ the assumption of the non-validity of the linear dynamic range is rejected

Example: Linearity study for the determination of tartaric acid by capillary electrophoresis. 9 reference materials are used. These are synthetic solutions of tartaric acid, titrated by means of a scale traceable to standard masses.

Ref. material	Ti (ref)	Y1	Y2	Y3	Y4
1	0.38	0.41	0.37	0.4	0.41
2	1.15	1.15	1.12	1.16	1.17
3	1.72	1.72	1.63	1.76	1.71
4	2.41	2.45	2.37	2.45	2.45
5	2.91	2.95	2.83	2.99	2.95
6	3.91	4.09	3.86	4.04	4.04
7	5.91	6.07	5.95	6.04	6.04
8	7.91	8.12	8.01	8.05	7.9
9	9.91	10.2	10	10.09	9.87

Regression line

Line ($y = a + b \cdot x$)

$$b = 1.01565$$

$$a = - 0.00798$$

Errors related to calibration

Residual standard deviation $S_{res} = 0.07161$

Standard deviation of experimental reproducibility $S_{exp} =$
 0.07536

Standard deviation of the adjustment error $S_{def} = 0.0548$

Interpretation, Fischer-Snedecor test

$$F_{obs} = 0.53 < F_{1-\alpha} = 2.37$$

***The assumption of the non-validity of the linear
dynamic range is rejected***

5.3.1.5 ISO 8466-type approach

5.3.1.5.1 Basic protocol

It is advisable to use a number n of reference materials. The number must be higher than 3, but there is no need, however, to exceed 10. The reference materials should be measured several times, under **reproducibility conditions**. The number of measurements may be small at the center of the range studied (minimum = 2) and must be greater at both ends of the range, for which a minimum number of 4 is generally recommended. The accepted values of reference materials must be regularly distributed over the studied range of values.

NOTE It is vital that the reproducibility conditions use the maximum number of potential sources of variability.

The results are reported in a table presented as follows:

Reference materials	Accepted value of the reference material	Measured values				
		Replica 1	Replica 2	Replica j	...	Replica p
I	x_1	y_{11}	y_{12}	y_{1j}	...	y_{1p}
...
i	x_i	y_{i1}	y_{i2}
...
N	x_n	y_{n1}	...	y_{nj}	...	y_{np}

5.3.1.5.2 Calculations and results

5.3.1.5.2.1 Defining the linear regression model

Calculate the linear regression model using the calculations detailed above.

The residual error of the standard deviation for the linear model S_{res} can then be calculated using the formula indicated in § 5.3.1.4.2.4.1

5.3.1.5.2.2 Defining the polynomial regression model

The calculation of the polynomial model of order 2 is given below

The aim is to determine the parameters of the polynomial regression model of order 2 applicable to the data of the experiment schedule.

$$y = a \mathcal{X}^2 + b\mathcal{X} + c$$

The purpose is to determine the parameters a, b and c. This determination can generally be computerized using spreadsheets and statistics software.

The estimation formulae for these parameters are as follows:

$$a = \frac{\sum_i x_i^2 y_i \left(N \sum_i x_i^2 - \left[\sum_i x_i \right]^2 \right) - \sum_i x_i^3 \left(N \sum_i x_i y_i - \sum_i x_i \sum_i y_i \right) + \sum_i x_i^2 \left(\sum_i x_i y_i \sum_i x_i - \sum_i y_i \sum_i x_i^2 \right)}{\sum_i x_i^4 \left(N \sum_i x_i^2 - \left[\sum_i x_i \right]^2 \right) - \sum_i x_i^3 \left(N \sum_i x_i^3 - \sum_i x_i^2 \sum_i x_i \right) + \sum_i x_i^2 \left(\sum_i x_i \sum_i x_i^3 - \left[\sum_i x_i^2 \right]^2 \right)}$$

$$b = \frac{\sum_i x_i^4 \left(N \sum_i x_i y_i - \sum_i x_i \sum_i y_i \right) - \sum_i x_i^2 y_i \left(N \sum_i x_i^3 - \sum_i x_i^2 \sum_i x_i \right) + \sum_i x_i^2 \left(\sum_i y_i \sum_i x_i^3 - \sum_i x_i y_i \sum_i x_i^2 \right)}{\sum_i x_i^4 \left(N \sum_i x_i^2 - \left[\sum_i x_i \right]^2 \right) - \sum_i x_i^3 \left(N \sum_i x_i^3 - \sum_i x_i^2 \sum_i x_i \right) + \sum_i x_i^2 \left(\sum_i x_i \sum_i x_i^3 - \left[\sum_i x_i^2 \right]^2 \right)}$$

$$c = \frac{\sum_i x_i^4 \left(\sum_i x_i^2 \sum_i y_i - \sum_i x_i \sum_i x_i y_i \right) - \sum_i x_i^3 \left(\sum_i x_i^3 \sum_i y_i - \sum_i x_i^2 \sum_i x_i y_i \right) + \sum_i x_i^2 y_i \left(\sum_i x_i \sum_i x_i^3 - \left[\sum_i x_i^2 \right]^2 \right)}{\sum_i x_i^4 \left(N \sum_i x_i^2 - \left[\sum_i x_i \right]^2 \right) - \sum_i x_i^3 \left(N \sum_i x_i^3 - \sum_i x_i^2 \sum_i x_i \right) + \sum_i x_i^2 \left(\sum_i x_i \sum_i x_i^3 - \left[\sum_i x_i^2 \right]^2 \right)}$$

Once the model has been established, the following values are to be calculated:

- regression value associated with the i^{th} reference material \hat{y}'_i

$$\hat{y}'_i = a \mathcal{X}^2 + b\mathcal{X} + c$$

- residual e_{ij} $e'_{ij} = y_{ij} - \hat{y}'_i$

Residual standard deviation of the polynomial model

$$S'_{res} = \sqrt{\frac{\sum_{i=1}^n \sum_{j=1}^p (y_{ij} - \hat{y}'_i)^2}{np - 2}}$$

5.3.1.5.2.3 Comparing residual standard deviations

Calculation of

$$DS^2 = (N - 2) S_{res}^2 - (N - 3) S'^2_{res}$$

Then

$$PG = \frac{DS^2}{S'^2_{res}}$$

The value PG is compared with the limit value $F_{1-\alpha}$ given by the Fischer-Snedecor table for a confidence level $1-\alpha$ and a degree of freedom 1 and (N-3).

NOTE In general the α risk used is 5%. In some cases the test may be optimistic and a risk of 10% will prove more realistic.

If $PG \leq F_{1-\alpha}$: the nonlinear calibration function does not result in an improved adjustment; for example, the calibration function is linear.

If $PG > F_{1-\alpha}$: the work scope must be as narrow as possible to obtain a linear calibration function: otherwise, the information values from the analyzed samples must be evaluated using a nonlinear calibration function.

Example: Theoretical case.

	Ti (ref)	Y1	Y2	Y3	Y4
1	35	22.6	19.6	21.6	18.4
2	62	49.6	49.8	53	
3	90	105.2	103.5		
4	130	149	149.8		
5	205	203.1	202.5	197.3	
6	330	297.5	298.6	307.1	294.2

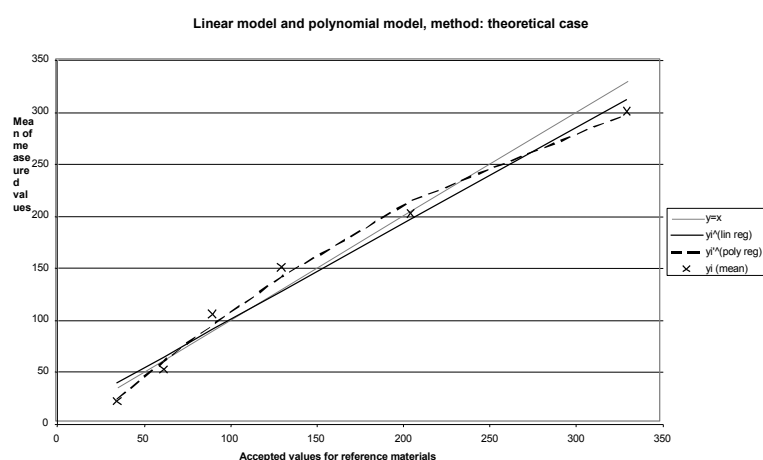

Linear regression

$$y = 1.48.x - 0.0015$$

$$S_{res} = 13.625$$

Polynomial regression

$$y = -0.0015x^2 + 1.485x - 27.2701$$

$$S'_{res} = 7.407$$

Fischer's test

$$PG = 10.534 > F(5\%) = 10.128$$

PG > F the linear calibration function cannot be retained

5.3.2 *Specificity*

5.3.2.1 *Normative definition*

The specificity of a method is its ability to measure only the compound being searched for.

5.3.2.2 *Application*

In case of doubt about the specificity of the tested method, the laboratory can use experiment schedules designed to check its specificity. Two types of complementary experiments are proposed here that can be used in a large number of cases encountered in the field of oenology.

- The first test is the standard addition test. It can be used to check that the method measures all the analyte.
- The second test can be used to check the influence of other compounds on the result of the measurement.

5.3.2.3 *Procedures*

5.3.2.3.1 *Standard addition test*

5.3.2.3.1.1 *Scope*

This test can be used to check that the method measures all the analyte. The experiment schedule is based on standard additions of the compound being searched for. It can only be applied to methods that are not sensitive to matrix effects.

5.3.2.3.1.2 *Basic protocol*

This consists in finding a significant degree of added quantities on test materials analyzed before and after the additions.

Carry out variable standard additions on *n* test materials. The initial concentration in analyte of test materials, and the standard additions are selected in order to cover the scope of the method. These test materials must consist of the types of matrices called for routine analysis. It is advised to use at least 10 test materials.

The results are reported in a table presented as follows:

Test material	Quantity before addition (<i>x</i>)	Quantity added (<i>v</i>)	Quantity after addition (<i>w</i>)	Quantity found (<i>r</i>)
1	x_1	v_1	w_1	$r_1 = w_1 - x_1$
...
<i>i</i>	x_i	v_i	w_i	$r_i = w_i - x_i$
...
<i>n</i>	X_n	V_n	w_n	$r_p = w_n - x_n$

NOTE 1 An addition is made with a pure standard solution. It is advised to perform an addition of the same order as the quantity of the test material on which it is carried out. This is why the most concentrated test materials must be diluted to remain within the scope of the method.

NOTE 2 It is advised to prepare the additions using independent standard solutions, in order to avoid any systematic error.

NOTE 3 The quality of values *x* and *w* can be improved by using several repetitions.

5.3.2.3.1.3 Calculations and results

The principle of the measurement of specificity consists in studying the regression line $r = a + b.v$ and checking that slope *b* is equivalent to 1 and that intercept point *a* is equivalent to 0.

5.3.2.3.1.3.1 Study of the regression line $r = a + b.v$

The parameters of the regression line are obtained using the following formulae:

- mean of the added quantities \bar{v} $\bar{v} = \frac{\sum_{i=1}^n v_i}{n}$

- mean of the quantities found \bar{r} $\bar{r} = \frac{\sum_{i=1}^n r_i}{n}$

- estimated slope b

$$b = \frac{\sum_{i=1}^n (v_i - \bar{v})(r_i - \bar{r})}{\sum_{i=1}^n (v_i - \bar{v})^2}$$

- estimated intercept point a

$$a = \bar{r} - b \cdot \bar{v}$$

- regression value associated with the i^{th} reference material \hat{y}_i

$$\hat{r}_i = a + b \times v_i$$

- residual standard deviation

$$S_{res} = \sqrt{\frac{\sum_{i=1}^n (r_i - \hat{r}_i)^2}{n - 2}}$$

- standard deviation on the slope

$$S_b = S_{res} \sqrt{\frac{1}{\sum_{i=1}^n (v_i - \bar{v})^2}}$$

- standard deviation on the intercept point

$$S_a = S_{res} \sqrt{\frac{1}{n} + \frac{\bar{v}^2}{\sum_{i=1}^n (v_i - \bar{v})^2}}$$

5.3.2.3.1.3.2 Analysis of the results

The purpose is to conclude on the absence of any interference and on an acceptable specificity. This is true if the overlap line $r = a + bv$ is equivalent to the line $y = x$.

To do so, two tests are carried out:

- Test of the assumption that slope b of the overlap line is equal to 1.
- Test of the assumption that intercept point a is equal to 0.

These assumptions are tested using a Student test, generally associated with a risk of error of 1%. A risk of 5% can prove more realistic in some cases.

Let $T_{critical, bilateral}[\text{dof}; 1\%]$ be a Student bilateral variable associated with a risk of error of 1% for a number of degrees of freedom (dof).

Step 1: calculations

Calculation of the comparison criterion on the slope at 1

$$T_{obs} = \frac{|b-1|}{S_b}$$

Calculation of the comparison criterion on the intercept point at 0

$$T_{obs} = \frac{|a|}{S_a}$$

Calculation of the Student critical value: $T_{critical, bilateral}[p-2; 1\%]$

Step 2: interpretation

- If T_{obs} is lower than $T_{critical}$, then the slope of the regression line is equivalent to 1
- If T'_{obs} is lower than $T_{critical}$, then the intercept point of the regression line is equivalent to 0.
- If both conditions are true, then the overlap line is equivalent = $y = x$, and the method is deemed to be specific.

NOTE 1 Based on these results, a mean overlap rate can be calculated to quantify the specificity. In no case should it be used to "correct" the results. This is because if a significant bias is detected, the alternative method cannot be validated in relation to an efficiency rate of 100%.

NOTE 2 Since the principle of the test consists in calculating a straight line, at least three levels of addition have to be taken, and their value must be correctly chosen in order to obtain an optimum distribution of the points.

5.3.2.3.1.3.3 Overlap line graphics

Example of specificity

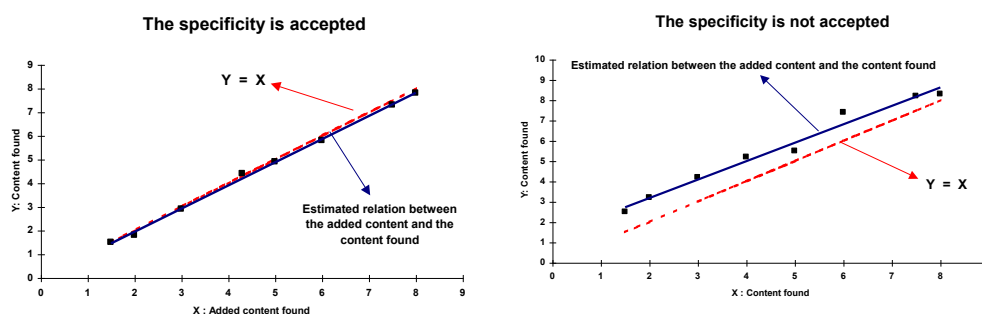

5.3.2.3.2 Study of the influence of other compounds on the measurement result

5.3.2.3.2.1 Scope

If the laboratory suspects the interaction of compounds other than the analyte, an experiment schedule can be set up to test the influence of various compounds. The experiment schedule proposed here enables a search for the influence of compounds defined *a priori*: thanks to its knowledge of the analytical process and its know-how, the laboratory should be able to define a certain number of compounds liable to be present in the wine and to influence the analytical result.

5.3.2.3.2.2 Basic protocol and calculations

Analyze n wines in duplicate, before and after the addition of the compound suspected of having an influence on the analytical result; n must at least be equal to 10.

The mean values Mx_i of the 2 measurements x_i and x'_i made before the addition shall be calculated first, then the mean values My_i of the 2 measurements y_i and y'_i made after the addition, and finally the difference d_i between the values Mx_i and My_i .

The results of the experiment can be reported as indicated in the following table:

**COMPENDIUM OF INTERNATIONAL ANALYSIS OF METHODS - OIV
Guide for the validation – quality control**

Samples	x: Before addition		y: After addition		Means		Difference
	Rep1	Rep2	Rep1	Rep2	x	y	d
1	x_1	x'_1	y_1	y'_1	Mx_1	My_1	$d_1 = Mx_1 - My_1$
...
i	x_i	x'_i	y_i	y'_i	Mx_i	My_i	$d_i = Mx_i - My_i$
...
n	x_n	x'_n	y_n	y'_n	Mx_n	My_n	$d_n = Mx_n - My_n$

The mean of the results before addition M_x

$$M_x = \frac{1}{n} \sum_{i=1}^n Mx_i$$

The mean of the results after addition M_y

$$M_y = \frac{1}{n} \sum_{i=1}^n My_i$$

Calculate the mean of the differences M_d

$$M_d = \sum_{i=1}^n \frac{d_i}{n} = My - Mx$$

Calculate the standard deviation of the differences S_d

$$S_d = \sqrt{\frac{\sum_{i=1}^n (d_i - M_d)^2}{n-1}}$$

Calculate the Z-score

$$Z_{score} = \frac{|M_d|}{S_d}$$

5.3.2.3.2.3 Interpretation

COMPENDIUM OF INTERNATIONAL ANALYSIS OF METHODS - OIV
Guide for the validation – quality control

- If the Z_{score} is ≤ 2 , the added compound can be considered to have a negligible influence on the result of analysis with a risk of 5%.
- If the Z_{score} is ≥ 2 , the added compound can be considered to influence the result of analysis with a risk of 5%.

NOTE Interpreting the Z_{score} is possible given the assumption that the variations obey a normal law with a 95% confidence rate.

Example: Study of the interaction of compounds liable to be present in the samples, on the determination of fructose glucose in wines by Fourier transform infrared spectrophotometry (FTIR).

vin	Before addition		+ 250 mg.L ⁻¹ potassium sorbate		+ 1 g. L ⁻¹ salicylic acid		Differences	
	rep1	rep2	rep1	rep2	rep1	rep2	sorbate diff	salicylic diff
1	6.2	6.2	6.5	6.3	5.3	5.5	0.2	-0.8
2	1.2	1.2	1.3	1.2	0.5	0.6	0.05	-0.65
3	0.5	0.6	0.5	0.5	0.2	0.3	-0.05	-0.3
4	4.3	4.2	4.1	4.3	3.8	3.9	-0.05	-0.4
5	12.5	12.6	12.5	12.7	11.5	11.4	0.05	-1.1
6	5.3	5.3	5.4	5.3	4.2	4.3	0.05	-1.05
7	2.5	2.5	2.6	2.5	1.5	1.4	0.05	-1.05
8	1.2	1.3	1.2	1.1	0.5	0.4	-0.1	-0.8
9	0.8	0.8	0.9	0.8	0.2	0.3	0.05	-0.55
10	0.6	0.6	0.5	0.6	0.1	0	-0.05	-0.55

Potassium sorbate $Md = 0.02$
 $Sd = 0.086$
 $Z_{score} = 0.23 < 2$

Salicylic acid $Md = -0.725$
 $Sd = 0.282$
 $Z_{score} = 2.57 > 2$

In conclusion, it can be stated that potassium sorbate does not influence the determination of fructose glucose by the FTIR gauging studied here. On the other hand, salicylic acid has an influence, and care should be taken to avoid

samples containing salicylic acid, in order to remain within the scope of validity for the gauging under study.

5.3.3 Study of method accuracy

5.3.3.1 Presentation of the step

5.3.3.1.1 Definition

Correlation between the mean value obtained with a large series of test results and an accepted reference value.

5.3.3.1.2 General principles

When the reference value is output by a certified system, the accuracy study can be regarded a traceability link. This applies to two specific cases in particular:

- Traceability to certified reference materials: in this case, the accuracy study can be undertaken jointly with the linearity and calibration study, using the experiment schedule described for that study.
- Traceability to a certified interlaboratory comparison analysis chain.

The other cases, i.e. which use references that are not based on certified systems, are the most widespread in routine oenological laboratories. These involve comparisons:

- Comparison with a reference method
- Comparison with the results of an uncertified interlaboratory comparison analysis chain.
- Comparison with internal reference materials, or with external uncertified reference materials.

5.3.3.1.3 Reference documents

- NF V03-110 Standard. intralaboratory validation procedure for an alternative method in relation to a reference method.
- NF V03-115 Standard, Guide for the use of reference materials.
- ISO 11095 Standard, linear calibration using reference materials.
- ISO 8466-1 Standard. Water quality – Calibration and evaluation of analytical methods and estimation of performance characteristics

- ISO 57025 Standard, Exactitude of results and methods of measurement

5.3.3.2 Comparison of the alternative method with the OIV reference method

5.3.3.2.1 Scope

This method can be applied if the laboratory uses the OIV reference method, or a traced, validated method, whose performance quality is known and meets the requirements of the laboratory's customers.

To study the comparative accuracy of the two methods, it is advisable first of all to ensure the quality of the repeatability of the method to be validated, and to compare it with the reference method. The method for carrying out the repeatability comparison is described in the chapter on repeatability.

5.3.3.2.2 Accuracy of the alternative method compared with the reference method

5.3.3.2.2.1 Definition

Accuracy is defined as the closeness of agreement between the values obtained by the reference method and that obtained by the alternative method, independent of the errors of precision of the two methods.

5.3.3.2.2.2 Scope

The accuracy of the alternative method in relation to the reference method is established for a field of application in which the repeatabilities of the two methods are constant.

In practice, it is therefore often advisable to divide the analyzable range of values into several sections or "range levels" (2 to 5), in which we may reasonably consider that the repeatabilities of the methods are comparable to a constant.

5.3.3.2.2.3 Basic protocol and calculations

In each range level, accuracy is based on a series of *n* test materials with concentration values in analyte covering the range level in question. A minimum number of 10 test materials is required to obtain significant results.

Each test material is to be analyzed in duplicate by the two methods under repeatable conditions.

A calculation is to be made of the mean values Mx_i of the 2 measurements x_i et x'_i made using the alternative method and the mean values My_i of the 2 measurements y_i et y'_i made using the reference method, then the difference d_i is to be calculated between the values Mx_i and My_i .

The results of the experiment can be reported as in the following table:

Test material	x: Alternative method		y: Reference method		Means		Difference <i>d</i>
	Rep1	Rep2	Rep1	Rep2	<i>x</i>	<i>y</i>	
<i>l</i>	x_l	x'_l	y_l	y'_l	Mx_l	My_l	$d_l = Mx_l - My_l$
...
<i>i</i>	x_i	x'_i	y_i	y'_i	Mx_i	My_i	$d_i = Mx_i - My_i$
...
<i>n</i>	x_n	x'_n	y_n	y'_n	Mx_n	My_n	$d_n = Mx_n - My_n$

The following calculations are to be made

- The mean of the results for the alternative method M_x

$$M_x = \frac{1}{n} \sum_{i=1}^n Mx_i$$

- The mean of the results for the reference method M_y

$$M_y = \frac{1}{n} \sum_{i=1}^n My_i$$

- Calculate the mean of the differences M_d

$$M_d = \sum_{i=1}^n \frac{d_i}{n} = Mx - My$$

- Calculate the standard deviation of the differences S_d

$$S_d = \sqrt{\frac{\sum_{i=1}^n (d_i - M_d)^2}{n-1}}$$

- Calculate the Z_{score}

$$Z_{score} = \frac{|M_d|}{S_d}$$

5.3.3.2.2.4 Interpretation

- If the Z_{score} is **lower** than or equal to 2.0, it can be concluded that the accuracy of one method in relation to the other is satisfactory, in the range level under consideration, with a risk of error $\alpha = 5\%$.

- If the Z_{score} is **higher** than 2.0, it can be concluded that the alternative method is not accurate in relation to the reference method, in the range level under consideration, with a risk of error $\alpha = 5\%$.

NOTE Interpreting the Z_{score} is possible given the assumption that the variations obey a normal law with a 95% confidence rate.

Example: Study of the accuracy of FTIR gauging to determine glucose and fructose in relation to the enzymatic method. The first range level covers the scale from 0 to 5 g.L⁻¹ and the second range level covers a scale from 5 to 20 g.L⁻¹.

Wine	FTIR 1	IRTF2	Enz 1	Enz 2	di
1	0	0.3	0.3	0.2	-0.1
2	0.2	0.3	0.1	0.1	0.2
3	0.6	0.9	0.0	0.0	0.7
4	0.7	1	0.8	0.7	0.1
5	1.2	1.6	1.1	1.3	0.2
6	1.3	1.4	1.3	1.3	0.0
7	2.1	2	1.9	2.1	0.0
8	2.4	0	1.1	1.2	0.1
9	2.8	2.5	2.0	2.6	0.3
10	3.5	4.2	3.7	3.8	0.1
11	4.4	4.1	4.1	4.4	0.0
12	4.8	5.4	5.5	5.0	-0.2

$$\begin{aligned}
 Md &= 0.13 \\
 Sd &= 0.23 \\
 Z_{score} &= 0.55 < 2
 \end{aligned}$$

Wine	FTIR 1	IRTF2	Enz 1	Enz 2	di
1	5.1	5.4	5.1	5.1	0.1
2	5.3	5.7	5.3	6.0	-0.2
3	7.7	7.6	7.2	7.0	0.6
4	8.6	8.6	8.3	8.5	0.2
5	9.8	9.9	9.1	9.3	0.6
6	9.9	9.8	9.8	10.2	-0.1
7	11.5	11.9	13.3	13.0	-1.4
8	11.9	12.1	11.2	11.4	0.7
9	12.4	12.5	11.4	12.1	0.7
10	16	15.8	15.1	15.7	0.5
11	17.7	18.1	17.9	18.3	-0.2
12	20.5	20.1	20.0	19.1	0.7

$$\begin{aligned}
 Md &= 0.19 \\
 Sd &= 0.63 \\
 Z_{score} &= 0.30 < 2
 \end{aligned}$$

For the two range levels, the Z_{score} is lower than 2. The FTIR gauging for the determination of fructose glucose studied here, can be considered accurate in relation to the enzymatic method.

5.3.3.3 Comparison by interlaboratory tests

5.3.3.3.1 Scope

Interlaboratory tests are of two types:

1. **Collaborative studies** relate to a single method. These studies are carried out for the initial validation of a new method, mainly in order to define the standard deviation of interlaboratory reproducibility $SR_{inter}(method)$. The mean m could also be given.

2. Interlaboratory comparison analysis chains, or **aptitude tests**. These tests are carried out for the validation of a method adopted by the laboratory, and the routine quality control (see § 5.3.3.3). The resulting value is the interlaboratory mean m , as well as the standard interlaboratory reproducibility and intermethod deviation S_{Rinter} .

By participating in an analysis chain, or in a collaborative study, the laboratory can exploit the results in order to study the accuracy of a method, in order to ensure its validation first of all, and its routine quality control.

If the interlaboratory tests are carried out within the framework of a certified organization, this comparison work can be used for method traceability.

5.3.3.3.2 Basic protocol and calculations

To obtain a sufficient comparison, it is recommended to use a minimum number of 5 test materials over the period.

For each test material, two results are provided:

- The mean of all the laboratories with significant results m
- The standard deviation for interlaboratory reproducibility $S_{R-inter}$

The test materials are analyzed with p replicas by the laboratory, these replicas being carried out under repeatable conditions. p must at least be equal to 2.

In addition, the laboratory must be able to check that the intralaboratory variability (intralaboratory reproducibility) is lower than the interlaboratory variability (interlaboratory reproducibility) given by the analysis chain.

For each test material, the laboratory calculates the Z_{score} , given by the following formula:

$$Z_{score} = \frac{|m_{lab} - m|}{S_{R-inter}}$$

COMPENDIUM OF INTERNATIONAL ANALYSIS OF METHODS - OIV
Guide for the validation – quality control

The results can be reported as indicated in the following table:

Test material	Rep1	...	Rep j	...	Rep p	Lab mean	Chain mean	Standard deviation	Z_{score}
1	x_{11}	...	x_{1j}	...	x_{1p}	$m_{lab} = \frac{\sum_{j=1}^p x_{1j}}{p}$	m_1	$S_{R-inter(1)}$	$Z_{score} = \frac{ m_{lab} - m_1 }{S_{R-inter(1)}}$
...
i	x_{i1}	...	x_{ij}	...	x_{ip}	$m_{lab} = \frac{\sum_{j=1}^p x_{ij}}{p}$	m_i	$S_{R-inter(i)}$	$Z_{score} = \frac{ m_{lab} - m_i }{S_{R-inter(i)}}$
...
n	x_{n1}	...	x_{nj}	...	x_{np}	$m_{lab} = \frac{\sum_{j=1}^p x_{nj}}{p}$	m_n	$S_{R-inter(n)}$	$Z_{score} = \frac{ m_{lab} - m_n }{S_{R-inter(n)}}$

5.3.3.3.3 Interpretation

If all the Z_{score} results are lower than 2, the results of the method being studied can be considered identical to those obtained by the laboratories having produced significant results.

NOTE Interpreting the Z_{score} is possible given the assumption that the variations obey a normal law with a 95% confidence rate.

Example: An interlaboratory analysis chain outputs the following results for the free sulfur dioxide parameter, on two samples.

Samples	x_1	x_2	x_3	x_4	Lab mean	Chain mean	Standard deviation	Z_{score}
1	34	34	33	34	33.75	32	6	0.29 < 2
2	26	27	26	26	26.25	24	4	0.56 < 2

It can be concluded that on these two samples, the comparison with the analysis chain is satisfactory.

5.3.3.4 Comparison with reference materials

5.3.3.4.1 Scope

In situations where there is no reference method (or any other method) for a given parameter, and the parameter is not processed by the analysis chains, the only remaining possibility is comparison of the results of the method to be validated with accepted internal or external material reference values.

The reference materials, for example, could be synthetic solutions established with class-A glassware, and/or calibrated metrology apparatus.

In the case of certified reference materials, the comparison constitutes the traceability value, and can be carried out at the same time as the gauging and linearity study.

5.3.3.4.2 Basic protocol and calculations

It is advisable to have n reference materials for a given range level, in which it can be reasonably estimated that repeatability is comparable to a constant; n must at least be equal to 10.

Analyze in duplicate each reference material.

Calculate the mean values Mx_i for the 2 measurements x_i and x'_i carried out using the alternative method.

Define T_i the accepted value for the i^{th} reference material.

The results can be reported as indicated in the following table:

Reference material	x: Alternative method			T: Accepted value of the reference material	Difference d
	Rep1	Rep2	Mean x		
1	x_1	x'_1	Mx_1	T_1	$d_1 = Mx_1 - T_1$
...		
i	x_i	x'_i	Mx_i	T_i	$d_i = Mx_i - T_i$
...		
n	x_n	x'_n	Mx_n	T_n	$d_n = Mx_n - T_n$

The mean of the results of the alternative method M_x

$$M_x = \frac{1}{n} \sum_{i=1}^n Mx_i$$

The mean of the accepted values of reference materials M_T

$$M_T = \frac{1}{n} \sum_{i=1}^n T_i$$

Calculate the mean of the differences M_d

$$M_d = \sum_{i=1}^n \frac{d_i}{n} = M_x - M_T$$

Calculate the standard deviation of the differences S_d

$$S_d = \sqrt{\frac{\sum_{i=1}^n (d_i - M_d)^2}{n-1}}$$

Calculate the Z-score

$$Z_{score} = \frac{|M_d|}{S_d}$$

5.3.3.4.3 Interpretation

- If the Z_{score} is **lower than** or equal to 2.0, it can be concluded that the accuracy of the alternative method in relation to the accepted values for the reference material is good on the range level under consideration.

- If Z_{score} is **higher** than 2.0, it can be concluded that the alternative method is not accurate in relation to the accepted values for the reference materials in the range level under consideration.

NOTE Interpreting the Z_{score} is possible given the assumption that the variations obey a normal law with a 95% confidence rate.

Example: There is no reference method to compare the results of the analysis of Ethyl-4 Phenol (4-EP) by Gas chromatography coupled with mass spectrometry (GC-MS). The results are compared with the accepted values for reference materials, consisting of synthetic solutions formulated by traced equipment.

Test apparatus	Ti (ref)	Y1	Y2	Y3	Y4	My	d _i
1	4.62	6.2	6.56	4.9	5.7	5.8	1.2
2	12.3	15.1	10.94	12.3	11.6	12.5	0.2
3	24.6	24.5	18	25.7	27.8	24.0	-0.6
4	46.2	48.2	52.95	46.8	35	45.7	-0.5
5	77	80.72	81.36	83.2	74.5	79.9	2.9
6	92.4	97.6	89	94.5	99.5	95.2	2.8
7	123.2	126.6	129.9	119.6	126.9	125.8	2.6
8	246.4	254.1	250.9	243.9	240.4	247.3	0.9
9	385	375.8	366.9	380.4	386.9	377.5	-7.5
10	462	467.5	454.5	433.3	457.3	453.2	-8.9

$$Md = -0.7$$

$$Sd = . 4.16$$

$$Z_{score} = 0.16$$

Given these results, the values obtained by the analysis method for 4-EP by GC-MS can be considered accurate compared with the accepted values of reference materials.

5.4 Section three: random error study

5.4.1 General principle

Random error is approximated using precision studies. Precision is calculated used a methodology that can be applied under various experimental conditions, ranging between those of repeatability, and those of reproducibility, which constitute the extreme conditions of its measurement.

The precision study is one of the essential items in the study of the uncertainty of measurement.

5.4.2 Reference documents

- ISO 5725 Standard, Exactitude of results and methods of measurement
- NF V03-110 Standard, Intralaboratory validation procedure for an alternative method in relation to a reference method.

5.4.3 Precision of the method

5.4.3.1 Definition

Closeness of agreement between independent test results obtained under prescribed conditions.

NOTE 1 Precision depends only on the distribution of the random errors and has no relation with the true or specified value.

NOTE 2 Expressing the measurement of precision is based on the standard deviation of the test results.

NOTE 3 The term "independent test results" refers to results obtained such that they are not influenced by a previous result on the same or similar test material. Quantitative measurements of precision are critically dependent on the prescribed conditions. Repeatability and reproducibility conditions are particular sets of extreme conditions.

In practice, precision refers to all the experimental conditions ranging between the conditions of repeatability and those of reproducibility.

5.4.3.2 Scope

The protocols and calculations are detailed below, from the general theoretical case to the specific cases of repeatability and reproducibility. This exhaustive approach should make it possible to apply the precision study in most laboratory situations.

The precision study can be applied a priori without difficulty to every quantitative method.

In many cases, precision is not constant throughout the validity range for the method. In this case, it is advisable to define several sections or "range levels", in which we may reasonably consider that the precision is comparable to a constant. The calculation of precision is to be reiterated for each range level.

5.4.3.3 General theoretical case

5.4.3.3.1 Basic protocol and calculations

5.4.3.3.1.1 Calculations with several test materials

n test materials are analyzed over a relatively long period of time with several replicas, *p_i* being the number of replicas for the *ith* test material. The properties of the test materials must maintain constant throughout the period in question. For each replica, the measurement can be made with *K* repetitions, (we do not take into account the case here where the number of repetitions *K* can vary from one test material to the other, which would complicate the calculations even more). The total number of replicas must be higher than 10, distributed over all the test materials.

The results can be reported as indicated in the following table, (case in which *K* = 2)

Replicas	1	...	j	p₁	p_i	p_n
<i>Test materials.</i>						
1	<i>x₁₁</i> <i>x'₁₁</i>	...	<i>x_{1j}</i> <i>x'_{1j}</i>	<i>x_{1p1}</i> <i>x'_{1p1}</i>		
...						
<i>i</i>	<i>x_{i1}</i> <i>x'_{i1}</i>	...	<i>x_{ij}</i> <i>x'_{ij}</i>	...	<i>x_{ipi}</i> <i>x'_{ipi}</i>	
...						
<i>n</i>	<i>x_{n1}</i> <i>x'_{n1}</i>	...	<i>x_{nj}</i> <i>x'_{nj}</i>	<i>x_{npn}</i> <i>x'_{npn}</i>

In this situation, the standard deviation of total variability (or standard deviation of precision *S_v*) is given by the general expression:

$$S_v = \sqrt{Var(\bar{x}_{ij}) + (1 - \frac{1}{k})Var(répet)}$$

where:

Var(\bar{x}_{ij}) variance of the mean of repeated replicas of all test materials.

Var(*répet*) variance of the repeatability of all the repetitions.

- If the test materials were analyzed in duplicate with each replica ($K = 2$), the expression becomes:

$$S_v = \sqrt{\text{Var}(\bar{x}_{ij}) + \frac{\text{Var}(\text{repeat})}{2}}$$

- When only one measurement of the test material has been carried out with each replica ($K = 1$), the variance of repeatability is null, the expression becomes:

$$S_v = \sqrt{\text{Var}(\bar{x}_{ij})}$$

- Calculation of $\text{Var}(\bar{x}_{ij})$

The mean of the two replicas x_{ij} and x'_{ij} is:

$$\bar{x}_{ij} = \frac{x_{ij} + x'_{ij}}{2}$$

For each test material, the mean of n replicas is calculated:

$$Mx_i = \frac{\sum_{j=1}^{p_i} \bar{x}_{ij}}{p_i}$$

The number of different measurements n is the sum of p_i

$$N = \sum_{i=1}^n p_i$$

The variance $Var(\bar{x}_{ij})$ is then given by the following equation

$$Var(x_{ij}) = \frac{\sum_{i=1}^n \sum_{j=1}^{p_i} (\bar{x}_{ij} - M_{x_i})^2}{N - n}$$

NOTE This variance can also be calculated using the variances of variability of each test material: $Var_i(x_j)$. The following relation is then used (it is strictly equivalent to the previous one):

$$Var(x_{ij}) = \frac{\sum_{i=1}^n (p_i - 1) Var_i(x_j)}{N - n}$$

- Calculation of $Var(repeat)$

The variance of repeatability is calculated as a conventional repeatability equation with n test materials in duplicate. According to the calculation of repeatability discussed in the section entitled "repeatability", for $K = 2$ the variance of repeatability is:

$$Var(repeat) = \frac{\sum_{i=1}^p \sum_{j=1}^{n_i} w_{ij}^2}{2N} \text{ where } w_{ij} = x_{ij} - x'_{ij}$$

Precision v is calculated according to the formula:

$$v = 2\sqrt{2} \cdot S_v = 2.8 \cdot S_v$$

The value of precision v means that in 95% of the cases, the difference between two values obtained by the method, under the conditions defined, will be lower than or equal to v .

NOTE 1 The use and interpretation of these results is based on the assumption that the variations obey a normal law with a 95% confidence rate.

NOTE 2 One can also define a precision of 99% with $v=2.58\sqrt{2} \cdot S_v=3.65 \cdot S_v$

5.4.3.3.1.2 Calculations with 1 test material

In this situation, the calculations are simpler. It is advisable to carry out p measurement replicas of the test material, if necessary with a repetition of the measurement on each replica. p must at least be equal to 10.

In the following calculations, the measurement is considered to be carried out in duplicate with each replica.

- The variance $Var(\bar{x}_{ij})$ is then given by the following equation:

$$Var(x_{ij}) = \frac{\sum_{i=1}^p (\bar{x}_i - M_x)^2}{p-1}$$

where:

\bar{x}_i is the mean of the two repetitions of replica i
 p is the number of replicas
 M_x is the mean of all the replicas

- The variance $Var(repeat)$ is then given by the following equation:

$$Var(repeat) = \frac{\sum_{i=1}^p w_i^2}{2p}$$

where w_i : difference between the two repetitions of replica i

5.4.3.4 Repeatability

5.4.3.4.1 Definitions

Repeatability is the closeness of agreement between mutually-independent analysis results obtained with the method in question on the same wine, in the same laboratory, with the same operator using the same equipment, within a short period of time.

These experimental conditions will be called conditions of repeatability.

The value of repeatability r is the value below which the absolute difference between two results of the same analysis is considered to be located, obtained under the conditions of repeatability defined above, with a confidence level of 95%.

The repeatability standard deviation S_r is the standard deviation for the results obtained under the conditions of repeatability. It is a parameter of the dispersion of the results, obtained under conditions of repeatability.

5.4.3.4.2 Scope

A priori, the repeatability study can be applied without difficulty to every quantitative method, insofar as the repeatability conditions can be observed.

In many cases, repeatability is not constant throughout the range of validity of the method. It is therefore advisable to define several sections or "range levels", in which we may reasonably consider that the repeatability is comparable to a constant. The repeatability calculation is then to be reiterated for each range level.

5.4.3.4.3 Basic protocol and calculations

5.4.3.4.3.1 General case

The number of test materials may vary in relation to the NUMBER of replicas. In practice, we consider that the number of measurements of all test materials must be higher than 20. It is not necessary for the repeatability conditions to be maintained from one test material to another, but all the replicas carried out on the same test material must be carried out under these repeatability conditions.

Repeatability remains a special case of the precision calculation $S_v = \sqrt{\text{Var}(\bar{x}_{ij}) + \frac{\text{Var}(\text{repeat})}{2}}$. The $\text{Var}(\text{repeat})$ part is naturally equal to 0 (only one measurement with each replica), and the calculation is the same as the calculation of $\text{Var}(x_{ij})$

$$S_r = \sqrt{\text{Var}(x_{ij})} = \sqrt{\frac{\sum_{i=1}^n \sum_{j=1}^{p_i} (\bar{x}_{ij} - M_{x_i})^2}{N - n}}$$

The value r means that in 95% of the cases, the difference between two values acquired under repeatable conditions will be lower than or equal to r .

5.4.3.4.3.2 Particular case applicable to only 1 repetition

In practice, the most current situation for automated systems is the analysis of test material with only one repetition. It is advisable to use at least 10 materials in order to reach the 20 measurements required. The two measurement replicas of the same test material must be carried out under repeatable conditions.

In this precise case, the calculation of S_r is simplified and becomes:

$$S_r = \sqrt{\frac{\sum_{i=1}^q w_i^2}{2p}}$$

in which:

S_r = the repeatability standard deviation

p = the number of test materials analyzed in duplicate

w_i = the absolute differences between duplicates

Repeatability r is calculated according to the formula:

$$r = 2.8 S_r$$

Example: For the alternative determination method of the free sulfur dioxide in question, and for a range of measurements from 0 to 50 mg/l, the operator will seek at least 10 samples with regularly distributed concentrations ranging between these values.

<i>Sample no.</i>	<i>x_i</i> <i>(in mg/l)</i>	<i>x'_i</i> <i>(in mg/l)</i>	<i>W_i</i> <i>(absolute value)</i>
1	14	14	0
2	25	24	1
3	10	10	0
4	2	3	1
5	35	35	0
6	19	19	0
7	23	23	0
8	27	27	0
9	44	45	1
10	30	30	0
11	8	8	0
12	48	46	2

Example: Using the values given in the table above, the following results are obtained:

$$Q = 12$$

$$S_r = 0.54 \text{ mg/l}$$

$$R = 1.5 \text{ mg/l}$$

This result can be used to state that, with a probability of 95%, the results obtained by the method under study will have a repeatability rate lower than 1.5 mg/l.

5.4.3.4.4 Comparison of repeatability

5.4.3.4.4.1 Determination of the repeatability of each method

To estimate the performance of a method, it can be useful to compare its repeatability with that of a reference method.

Let S_{r-alt} be the repeatability standard deviation of the alternative method, and S_{r-ref} the repeatability standard deviation of the reference method.

The comparison is direct. If the value of repeatability of the alternative method is lower than or equal to that of the reference method, the result is positive. If it is higher, the laboratory must ensure that the result rests compliant with the specification that it accepted for the method concerned. In the latter case, it may also apply a Fischer-Snedecor test to know if the value found for the alternative method is significantly higher than that of the reference method.

5.4.3.4.4.2 *Fischer-Snedecor test*

Calculate the ratio:

$$F_{obs} = \frac{S_{r-alt}^2}{S_{r-ref}^2}$$

Use the critical Snedecor value with a risk α equal to 0.05 corresponding to the Fischer variable with a confidence level $1 - \alpha$, in which $v_1 = n(x) - 1$, and $v_2 = n(z) - 1$ degrees of freedom: $F(N(x)-1, N(z)-1, 1 - \alpha)$. In the case of a calculated repeatability with only one repetition on p test materials for the alternative method, and q test materials for the reference method, the Fischer variable will have as a degree of freedom $v_1 = p$, and $v_2 = Q$, i.e.: $F(p, Q, 1 - \alpha)$.

Interpreting the test:

1/ $F_{obs} > F_{1-\alpha}$, the repeatability value of the alternative method is significantly higher than that of the reference method.

2/ $F_{obs} < F_{1-\alpha}$, we cannot state that the repeatability value of the alternative method is significantly higher than that of the reference method.

***Example:** The value of the repeatability standard deviation found for the determination method of free sulfur dioxide is:*

$$Sr = 0.54 \text{ mg/l}$$

The laboratory carried out the determination on the same test materials using the OIV reference method. The value of the repeatability standard deviation found in this case is:

$$S_{ref} = 0.39 \text{ mg/l}$$

$$F_{obs} = \frac{0.54^2}{0.39^2} = \frac{0.29}{0.15} = 1.93$$

$$v_2 = 12$$

$$v_1 = 12$$

$$F_{1-\alpha} = 2.69 > 1.93$$

The F_{obs} value obtained is lower than the value $F_{1-\alpha}$; we cannot state that the repeatability value of the alternative method is significantly higher than that of the reference method.

5.4.3.5 Intralaboratory reproducibility

5.4.3.5.1 Definition

Intralaboratory reproducibility is the closeness of agreement between the analysis results obtained with the method under consideration on the same wine, in the same laboratory, with the same operator or different operators using from the different gauging curves, on different days.

5.4.3.5.2 Scope

Reproducibility studies can be implemented on quantitative methods, if the time of analysis is reasonably limited, and if the capacity exists to keep at least one test material stable over time.

In many cases, reproducibility is not constant throughout the validity range of the method. In this case, it is advisable to define several sections or "range levels", in which it can be reasonably considered that reproducibility is comparable to a constant. The reproducibility calculation is then to be reiterated for each range level.

5.4.3.5.3 Basic protocol and calculations

The laboratory chooses one or more stable test materials. It applies the method regularly for a period equal to at least one month and keeps the results obtained (X_{ij} , **material i , replica j**). A minimum of 5 replicas is recommended for each test material, the total minimum number of replicas being 10. The replicas can be analyzed in duplicate.

The calculation of precision fully applies to the calculation of reproducibility, integrating $Var(repeat)$ if the measurements are carried out in duplicate.

Reproducibility R is calculated according to the formula:

$$R = 2.8 S_R$$

The value R means that in 95% of the cases, the difference between two values acquired under reproducibility conditions will be lower than or equal to R .

Example: Reproducibility study of the determination of the sorbic acid in wines by steam distillation and reading by absorption at 256 Nm.

Two different sorbated wines were kept for a period of 3 months. The determination of the sorbic acid was carried out at regular intervals over this period, with repetition of each measurement.

Replicas	Test material 1		Test material 2	
	x1	x2	x1	x2
1	122	125	140	139
2	123	120	138	137
3	132	130	139	141
4	121	115	143	142
5	130	135	139	139
6	135	142	135	138
7	137	135	139	139
8	130	125	145	145
9	123	130	138	137
10	112	115	135	134
11	131	128	146	146
12			137	138
13			146	147
14			145	148
15			130	128

$$n = 2$$

$$p_1 = 11$$

$$p_2 = 15$$

$$n = 26$$

$$\text{Var}(x_{ij})=37.8$$

$$\text{Var}(\text{repet})=5.01$$

$$S_R = 6.35$$

$$R = 17.8$$

6. Quality control of analysis methods (IQC)

6.1 Reference documents

- Resolution OIV CEno 19/2002: Harmonized recommendations for internal quality control in analysis laboratories.
- CITAC/EURACHEM: Guide for quality in analytical chemistry, 2002 Edition
- Standard NF V03-115, Guide for the use of reference materials

6.2 General principles

It is recalled that an analysis result can be affected two types of error: systematic error, which translates into bias, and random error. For series analyses, another type of error can be defined, which can be due to both systematic error and random error: this is the series effect, illustrated for example by the deviation of the measuring system during a series.

The IQC is designed to monitor and control these three errors.

6.3 Reference materials

The IQC is primarily based on exploiting the measurement results for reference materials. The choice and constitution of the materials are therefore essential steps that it must be controlled in order to provide an efficient basis for the system.

A reference material is defined by two parameters:

- Its matrix
- The assignment of its reference value

Several cases are possible; the cases encountered in oenology are summarized in the following two-dimensional table:

COMPENDIUM OF INTERNATIONAL ANALYSIS OF METHODS - OIV
Guide for the validation – quality control

Reference value	Synthetic solution	Natural matrix (wine etc.)	Doped wine
<i>Value obtained by formulation</i>	<i>Synthetic solutions can be used to constitute the solution must be produced using metrological rules. It is recalled that the formulation value</i>	<i>Natural matrices a priori constitute the most interesting</i> Not applicable	<i>A doped wine is a wine with an artificial addition of an analyte</i> This method is applicable when the base wine is completely free of analyte. These types of materials are suitable for oenological additives that are not native to the wine. If
<i>External value to the laboratory</i>	The organization supplying the solution must provide guarantees about its quality and be certified if possible. The reference values will be	The external value has been determined on the wine by an interlaboratory analysis chain. Certain organizations propose conditioned wine samples whose values have been determined in	In practice, this involves conditioned wine samples doped and/or chemically stabilized as proposed by organizations. These materials cannot claim to constitute a natural matrix. The reference values are
<i>Value obtained by a reference method</i>	If the synthetic solution has not been obtained with a calibrated material, the reference value can be determined by analyzing the	The measurement is carried out 3 times with the reference method, the selected value is the mean of the 3 results, insofar as they remain within an interval lower than the repeatability of the	The measurement is carried out 3 times with the reference method, the value retained is the mean of the 3 results, insofar as they remain within an interval lower than the repeatability of the method.
<i>of the instrument value as a reference value does not control accuracy</i>	The reference value is measured by the method to be checked. The material is measured over 10 repetitions, and a check will be made that the differences between these values are lower	The reference value is measured by the method to be checked. The material is measured over 10 repetitions, and a check is to be made that the differences between these values are lower than the repeatability value; the most extreme values can be withdrawn,	The reference value is measured using the method to be checked. The material is measured over 10 repetitions, and a check is made to ensure that the differences between these values are lower than the repeatability value; the most extreme values can be withdrawn, up to a

6.4 Checking the analytical series

6.4.1 Definition

An analytical series is a series of measurements carried out under repeatable conditions.

For a laboratory that mainly uses the analytical series method of analysis, a check must be made to ensure the instantaneous adjustment of the measuring instrument and its stability during the analytical series is correct.

Two complementary approaches are possible:

- the use of reference materials (often called by extension "control materials")
- the use of an internal standard, in particular for separative methods.

6.4.2 Checking accuracy using reference materials

Systematic error can be checked by introducing reference materials, the reference value of which has been assigned using means external to the method being checked.

The measured value of the reference material is associated with a tolerance limit, inside which the measured value is accepted as being valid. The laboratory defines tolerance values for each parameter and for each analytical system. **These values are specific to the laboratory.**

The control materials must be selected so that their reference values correspond to the levels of the values usually found for a given parameter. If the scale of measurement is broad, and the uncertainty of measurement is not constant on the scale, several control materials should be used to cover the various range levels.

6.4.3 Intraserie precision

When the analytical series are rather long, there is a risk of drift of the analytical system. In this case, intraserie precision must be checked using the same reference material positioned at regular intervals in the series. The same control materials as those used for accuracy can be used.

The variation in the measured values for same reference material during the series should be lower than the repeatability value r calculated for a confidence level of 95%.

NOTE For a confidence level of 99%, a value of $3.65.S_r$ can be used.

6.4.4 Internal standard

Certain separative methods enable the introduction of an internal standard into the product to be analyzed.

In this case, an internal standard should be introduced with calibrated material with a known uncertainty of measurement.

The internal standard enables a check to be made both of intraseries accuracy and precision. It should be noted that a drift affects the signals of the analyte and of the internal standard in equal proportions; since the value of the analyte is calculated with the value of the signal of the internal standard, the effect of the drift is cancelled.

The series will be validated if the internal standards are inside the defined tolerance values.

6.5 Checking the analysis system

6.5.1 Definition

This concerns an additional check to the series check. It differs from the latter in that it compiles values acquired over long time scales, and/or compares them with values resulting from other analysis systems.

Two applications will be developed:

- Shewhart charts to monitor the stability of the analysis system
- Internal and external comparison of the analysis system

6.5.2 Shewhart chart

Shewhart charts are graphic statistical tools used to monitor the drift of measurement systems, by the regular analysis, in practice under reproducibility conditions, of stable reference materials.

6.5.2.1 Data acquisition

A stable reference material is measured for a sufficiently long period, at defined regular intervals. These measurements are recorded and logged in control charts. The measurements are made under reproducibility conditions, and are in fact

exploitable for the calculation of reproducibility, and for the assessment of measurement uncertainty.

The values of the analytical parameters of the reference materials selected must be within valid measurement ranges.

The reference materials are analyzed during an analytical series, routine if possible, with a variable position in the series from one time to another. In practice, it is perfectly possible to use the measurements of control materials of the series to input the control charts.

6.5.2.2 Presentation of results and definition of limits

The individual results are compared with the accepted value of the reference material, and with the reproducibility standard deviation for the parameter in question, at the range level in question.

Two types of limits are defined in the Shewhart charts, the limits associated with individual results, and the limits associated with the mean.

The limits defined for the individual results are usually based on the standard deviation values for intralaboratory reproducibility for the range level in question. They are of two types:

- alert limit: $+/- 2.S_R$.
- action limit: $+/- 3.S_R$.

The limit defined for the cumulated mean narrows as the number of measurements increases.

- This limit is an action limit: $+/- \frac{3.S_R}{\sqrt{n}}$. **n** being the number of measurements indicated on the chart.

NOTE For reasons of legibility, the alert limit of the cumulated mean is only rarely reproduced on the control chart, and has as its value $+/- \frac{2.S_R}{\sqrt{n}}$.

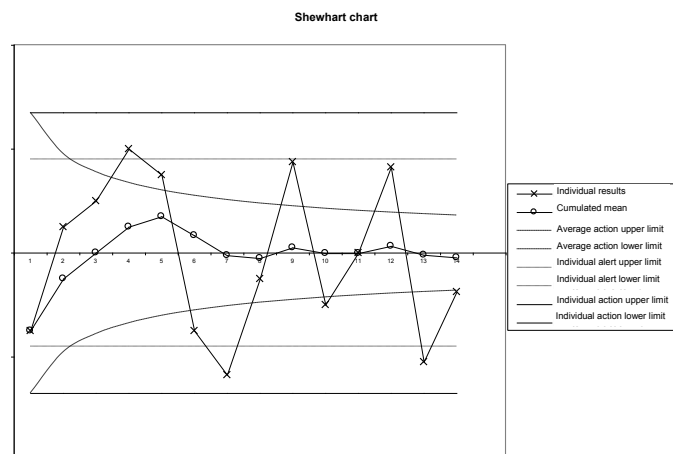

6.5.2.3 Using the Shewhart chart

Below we indicate the operating criteria most frequently used. It is up to the laboratories to precisely define the criteria they apply.

Corrective action on the method (or the apparatus) will be undertaken:

- a) if an individual result is outside the action limits of the individual results.
- b) if two consecutive individual results are located outside the alert limits of individual results.
- c) if, in addition, *a posteriori* analysis of the control charts indicates a drift in the method in three cases:
 - nine consecutive individual result points are located on the same side of the line of the reference values.
 - six successive individual result points ascend or descend.
 - two successive points out of three are located between the alert limit and the action limit.
- d) if the arithmetic mean of *n* recorded results is beyond one of the action limits of the cumulated mean (which highlights a systematic deviation of the results).

NOTE The control chart must be revised at *n* = 1 as soon as a corrective action has been carried out on the method.

6.5.3 Internal comparison of analysis systems

In a laboratory that has several analysis methods for a given parameter, it is interesting to carry out measurements of the same test materials in order to compare the results. The agreement of the results between the two methods is considered to be satisfactory if their variation remains lower than 2 times the standard deviation of difference calculated during validation, with a confidence level of 95%.

NOTE This interpretation is possible given the assumption that the variations obey a normal law with a 95% confidence rate.

6.5.4 External comparison of the analysis system

6.5.4.1 Analysis chain of interlaboratory comparisons

The organization of the tests and calculations is given in the chapter "comparison with an interlaboratory analysis chain".

In addition to checking the accuracy by the Z_{score} the results can be analyzed in greater detail, in particular with regard to the position of the values of the laboratory in relation to the mean. If they are systematically on the same side of the mean for several successive analysis chains, this can justify the implementation of corrective action by the laboratory, even if Z_{score} remains lower than the critical value.

NOTE Interpreting the Z_{score} is possible given the assumption that the variations obey a normal law with a 95% confidence rate.

If the intercomparison chain is subject to accreditation, this work of comparison has traceability value.

6.5.4.2 Comparison with external reference materials

Measuring external reference materials at regular intervals also can be used to supervise the occurrence of a systematic error (bias).

The principle is to measure the external reference material, and to accept or refuse the value in relation to tolerance limits. These limits are defined in relation to the

combination of the uncertainties of the controlled method and the reference value of the reference material.

6.5.4.2.1 Standard uncertainty of reference material

The reference values of these materials are accompanied by confidence intervals. The laboratory must determine the nature of this data, and deduce from them the standard uncertainty value for the reference value S_{ref} . A distinction must be made between several cases:

- The case in which uncertainty a is given in the form of an interval confidence at 95% (expanded uncertainty). This means that a normal law has been adopted. a therefore constitutes an "expanded uncertainty" and corresponds to 2 times the standard deviation S_{ref} of the standard uncertainty of the reference values of the materials provided.

$$S_{ref} = \frac{a}{2}$$

- The case of a certificate, or another specification, giving limits +/- a without specifying the confidence level. In this case, a rectangular dispersion has been adopted, and the value of measurement X has the same chance of having an unspecified value in the interval $ref \pm a$.

-

$$S_{ref} = \frac{a}{\sqrt{3}}$$

- The particular case of glassware giving limits +/- a . This is the framework of a triangular dispersion.

-

$$S_{ref} = \frac{a}{\sqrt{6}}$$

6.5.4.2.2 Defining the validity limits of measuring reference material

To standard uncertainty S_{ref} of the value of the external reference material, is added the standard uncertainty of the laboratory method to be checked, S_{method} . These two sources of variability must be taken into account in order to determine the limits.

S_{method} is calculated from the expanded uncertainty of the laboratory method in the following way:

$$S_{method} = \frac{uncertainty}{2}$$

The validity limit of the result (with a confidence level of 95%) =

$$reference\ value \pm 2 \cdot \sqrt{S_{ref}^2 + S_{method}^2}$$

Example: A pH 7 buffer solution is used to check a pH-meter. The confidence interval given by the pH solution is +/- 0.01. It is indicated that this confidence interval corresponds to the expanded uncertainty with a confidence level of 95%. In addition the expanded uncertainty of the pH-meter is 0.024.

The limits will be $\pm 2 \cdot \sqrt{\left(\frac{0.01}{2}\right)^2 + \left(\frac{0.024}{2}\right)^2}$

i.e. +/- **0.026** in relation to the reference value, with a confidence level of 95%.

7. Assessment of measurement uncertainty

7.1 Definition

Parameter, associated with the result of a measurement, which characterizes the dispersion of the values that can reasonably be allotted to the measurand.

In practice, uncertainty is expressed in the form of a standard deviation called standard uncertainty $u(x)$, or in an expanded form (generally with $k = 2$) $U = \pm k \cdot u$

7.2 Reference documents

- AFNOR ENV 13005 Standard: 1999 – Guide for expressing measurement uncertainty
- EURACHEM, 2000. Quantifying Uncertainty in Analytical Measurement, *EURACHEM second edition 2000*
- ISO 5725 Standard: 1994 – Exactitude (accuracy and precision) of results and measurement methods
- ISO 21748 standard: 2004 – Guidelines relating to the use of estimations of repeatability, reproducibility and accuracy in evaluating measurement uncertainty
- Perruchet C and Priel M., Estimating uncertainty, *AFNOR Publications, 2000*

7.3 Scope

Uncertainty provides two types of information.

- On the one hand, that intended for the customers of the laboratory, indicating the potential variations to take into account in order to interpret the result of an analysis. It must be indicated, however, that this information cannot be used as an external means of evaluating the laboratory.
- In addition, it constitutes a dynamic in-house tool for evaluating the quality of the laboratory analysis results. Insofar as its evaluation is regular and based on a fixed, well-defined methodology, it can be used to see whether the variations involved in a method change positively or negatively (in the case of an estimate based exclusively on intralaboratory data).

The present guide limits itself to providing a practical methodology for oenological laboratories dealing with series analyses. These laboratories have large volumes of data of a significant statistical scale.

Estimating uncertainties can therefore be carried out in most cases using the data collected as part validation and quality control work (in particular with the data in the Shewhart charts). These data can be supplemented by experiment schedules, in particular to determine the systematic errors.

The reference systems describe two main approaches for determining uncertainty: the intralaboratory approach and the approach interlaboratory. Each provides results that are naturally and significantly different. Their significance and their interpretation cannot be identical.

- **the intralaboratory approach** provides a result specific to the method in question, in the laboratory in question. The uncertainty that results is an indicator of the performance of the laboratory for the method in question. It answers the customer as follows: "what dispersion of results can I expect from the laboratory practicing the method?"
- **the interlaboratory approach** uses results resulting from interlaboratory tests, which provide information about the overall performance of the method.

Laboratories can use the two approaches jointly. It will be interesting to see whether the results obtained using the intralaboratory approach give values lower than the values of the interlaboratory approach.

7.4 Methodology

The work of uncertainty assessment involves 3 fundamental steps.

- Definition of the measurand, and description of the quantitative analysis method
- Critical analysis of the measurement process
- Uncertainty assessment.

7.4.1 Definition of the measurand, and description of the quantitative analysis method

First of all, the following must be specified:

- the purpose of the measurement
- the quantity measured
- If the measurand is to be obtained by calculation based on measured quantities, if possible the mathematical relation between them should be stipulated.
- all the operating conditions.

These items are included in theory in the procedures of the laboratory quality system.

In certain cases the expression of the mathematical relation between the measurand and the quantities can be highly complex (physical methods etc.), and it is neither necessarily relevant nor possible to fully detail them.

7.4.2 Critical analysis of the measurement process

The sources of error influencing the final result should be identified in order to constitute the uncertainty budget. The importance of each source can be estimated, in order to eliminate those that have only a negligible minor influence. This is done by estimating:

- the degree of gravity of the drift generated by poor control of the factor in question
- the frequency of the potential problems
- their detectability.

This critical analysis can, for example, be carried out using the "5M" method.

Labor:

Operator effect

Matter:

Sample effect (stability, homogeneity, matrix effects), and consumables (reagents, products, solutions, reference materials), etc.

Hardware:

Equipment effect (response, sensitivity, integration modes, etc.), and laboratory equipment (balance, glassware etc.).

Method:

Application effect of the procedure (operating conditions, succession of the operations etc.).

Medium:

Environmental conditions (temperature, pressure, lighting, vibration, radiation, moisture etc.).

7.4.3 Estimation calculations of standard uncertainty (intralaboratory approach)

7.4.3.1 Principle

In the case of laboratories using large series of samples with a limited number of methods, a statistical approach based on intralaboratory reproducibility, supplemented by the calculation of sources of errors not taken into account under

intralaboratory reproducibility conditions, appears to be the most suitable approach.

An analysis result deviated from the true value under the effect of two sources of error: systematic errors and random errors.

$$\text{Analysis result} = \text{True value} + \text{Systematic error} + \text{Random error}$$

Uncertainty characterizes the dispersion of the analysis result. This translates into a standard deviation.

Variability (analysis result) = uncertainty

Variability (true value) = 0

$$\text{Variability (systematic error)} = \sqrt{\sum S_{\text{erreurs_systématiques}}^2}$$

Variability (random error) = S_R (intralaboratory reproducibility standard deviation)

Since standard deviations are squared when added, the estimated standard uncertainty $u(x)$ takes the following form:

$$u(x) = \sqrt{\sum u_{(\text{systematic_errors})}^2 + S_R^2}$$

Non-integrable sources of errors under the intralaboratory reproducibility conditions, i.e. systematic errors, must be determined in the form of standard deviation to be combined together and with the reproducibility standard deviation.

The laboratory can take action so that the reproducibility conditions applied make it possible to include a maximum number of sources of errors. This is obtained in particular by constituting stable test materials over a sufficiently long period, during which the laboratory takes care to vary all the possible experimental factors. In this way, S_R will cover the greatest number of possible sources of errors (random), and the work involved in estimating the systematic errors, which is often more complex to realize, will be minimized.

It should be noted here that the EURACHEM/CITAC guide entitled "Quantifying uncertainty in analytical measurements" recalls that "In general, the ISO Guide requires that corrections be applied for all systematic effects that are identified and significant". In a method "under control", systematic errors should therefore constitute a minor part of uncertainty.

COMPENDIUM OF INTERNATIONAL ANALYSIS OF METHODS - OIV
Guide for the validation – quality control

The following non-exhaustive table gives examples of typical sources of error and proposes an estimation approach for each of them, using integration under reproducibility conditions as much as possible.

<i>Source of error</i>	<i>Type of error</i>	<i>Commentary</i>	<i>Estimation method</i>
Sampling (constitution of the sample)	Random	Sampling is one of the "businesses" defined in the ISO 17025 standard. Laboratories stating they do not perform sampling, do not include this source of error in the uncertainty assessment.	Can be including in intralaboratory reproducibility by including sampling in handling.
Sub-sampling (sampling a quantity of sample in order to carry out the test)	Random	Is significant if the sample is not homogeneous. This source of error remains minor for wine.	Included in the intralaboratory reproducibility conditions if the test material used is similar to routine test materials.
Stability of the sample	Random	Depends on the storage conditions of the sample. In the case of wines, laboratories should pay detailed attention to the losses of sulfur dioxide and ethanol.	Possible changes in the sample can be integrated into the reproducibility conditions. This source of uncertainty can then be evaluated overall.
Gauging of the apparatus	Systematic/Random	This error is systematic if gauging is established for a long period, and becomes random if gauging is regularly carried out over a time-scale integrated under reproducibility conditions	Source of error to be taken into account in absolute methods. Error of gauging line § 7.4.2.4.1 Taken into account under the reproducibility conditions if gauging is regularly revised.
Effect of contamination or memory	Random	This effect will be minimized by the proper design of measuring instruments and suitable rinsing operations	The reproducibility conditions take this effect into account, as long as the reference materials are inserted at various positions in the analysis series.
Precision of automata	Random	This applies to intraseries drift in particular. This can be controlled in particular by positioning the control materials within the framework of the IQC	The reproducibility conditions take this effect into account, as long as the reference materials are inserted at various positions in the analysis series.

COMPENDIUM OF INTERNATIONAL ANALYSIS OF METHODS - OIV
Guide for the validation – quality control

Purity of the reagents	Random	The purity of the reagents has very little effect on the relative methods, insofar as the gauging and analyses are carried out with the same batches of reagents. This effect is to be taken into account in absolute methods.	To be integrated under reproducibility conditions using various batches of reagents.
Measurement conditions	Random	Effects of temperature, moisture etc.	Typically taken into account under reproducibility conditions
Matrix effect	Random from one sample to another, systematic on the same sample	These effects are to be taken into account in methods whose measured signal is not perfectly specific.	If this effect is regarded as significant, a specific experiment schedule can be used to estimate uncertainty due to this effect § 7.4.2.4.3 This effect is not integrated under reproducibility conditions.
Gauging effect	Systematic if gauging is constant Random if gauging is regularly renewed		Taken into account under the reproducibility conditions if gauging is regularly renewed. If the gauging used remains the same one (on the scale of the periods in question within the framework of the reproducibility conditions), it is advisable to implement an experiment schedule in order to estimate the error of the gauging line § 7.4.2.4.1
Operator effect	Random		To be taken into account in the reproducibility conditions by taking care to utilize all the authorized operators.
Bias	Systematic	Must be minimized by the quality control work of the laboratory.	Systematic effect, can be estimated using certified references.

7.4.3.2 Calculating the standard deviation of intralaboratory reproducibility

The reproducibility standard deviation S_R is calculated using the protocol described in the section entitled "Intralaboratory reproducibility" (cf. § 5.4.3.5).

The calculation can be based on several test materials. In the noteworthy case where S_R is proportional to the size of the measurand, the data collected on several test materials with different values should not be combined: S_R should be expressed in relative value (%).

7.4.3.3 Estimating typical sources of systematic errors not taken into account under reproducibility conditions

7.4.3.3.1 Gauging error (or calibration error)

Whenever the gauging of an instrument (or the calibration of an absolute method) is not regularly redone, its output cannot be integrated in the reproducibility values. An experiment schedule must be carried out in order to estimate it using the residual error of the regression.

7.4.3.3.1.1 Procedure

The approach is similar to that carried out in the linearity study of the method.

It is recommended to implement a number *n* of reference materials. The number must be higher than 3, but it is not necessary to go beyond 10. The reference materials are to be measured *p* times under intralaboratory precision conditions, *p* must be higher than 3, a figure of 5 is generally recommended. The accepted values of reference materials must be regularly distributed on the range of values under study. The number of measurements must be the same for all the reference materials.

The results are reported in a table presented as follows:

Reference materials	Accepted value of the reference material	Measured values				
		Replica 1	...	Replica j	...	Replica p
<i>l</i>	x_l	y_{l1}	...	y_{lj}	...	y_{lp}
...
<i>i</i>	x_i	y_{i1}	...	y_{ij}	...	y_{ip}
...
<i>n</i>	x_n	y_{n1}	...	y_{nj}	...	y_{np}

7.4.3.3.1.2 Calculations and results

The linear regression model is calculated.

$$y_{ij} = a + b \cdot x_i + \varepsilon_{ij}$$

where

y_{ij} is j^{th} replica of the i^{th} reference material.

x_i is the accepted value of the i^{th} reference material.

b is the slope of the regression line.

a is the intercept point of the regression line.

$a + b \cdot x_i$ represent the expectation of the measurement value of the i^{th} reference material.

ε_{ij} is the difference between y_{ij} and the expectation of the measurement value of the i^{th} reference material.

The parameters of the regression line are obtained using the following formulae:

- mean of p measurements of the i^{th} reference material

$$y_i = \frac{1}{p} \sum_{j=1}^p y_{ij}$$

- mean of all the accepted values of n reference materials

$$M_x = \frac{1}{n} \sum_{i=1}^n x_i$$

- mean of all measurements

$$M_y = \frac{1}{n} \sum_{i=1}^n y_i$$

- estimated slope b

$$b = \frac{\sum_{i=1}^n (x_i - M_x)(y_i - M_y)}{\sum_{i=1}^n (x_i - M_x)^2}$$

- estimated intercept point a

$$a = M_y - b \times M_x$$

- regression value associated with the i^{th} reference material \hat{y}_i

$$\hat{y}_i = a + b \times x_i$$

- residual e_{ij}

$$e_{ij} = y_{ij} - \hat{y}_i$$

7.4.3.1.3 Estimating the standard uncertainty associated the gauging line (or calibration line)

If the errors due to the regression line are constant over the entire field, the standard uncertainty is estimated in a global, single way by the overall residual standard deviation.

$$u_{(gauging)} = S_{res} = \sqrt{\frac{\sum_{i=1}^n \sum_{j=1}^p (y_{ij} - \hat{y}_i)^2}{np - 2}}$$

If the errors due to the regression line are not constant over the entire field, the standard uncertainty is estimated for a given level by the residual standard deviation for this level.

$$u_{(gauging),i} = S_{res,i} = \sqrt{\frac{\sum_{j=1}^p (y_{ij} - \hat{y}_i)^2}{p - 1}}$$

NOTE These estimates of standard deviations can be used if the linear regression model and the gauging (or calibration) domain have been validated (see § 5.3.1)

7.4.3.3.2 Bias error

According to the EURACHEM guide, "*Quantifying uncertainty in analytical measurements*", it is recalled that the ISO guide generally requires that corrections be applied for all identified significant systematic effects. The same applies to the bias of methods for which the laboratory implements its quality control system (see §6), and which tends towards 0 for methods "under control".

In practice, a distinction can be made between two cases:

7.4.3.3.2.1 Methods adjusted with only one certified reference material

Bias is permanently adjusted with the same reference material.

The certified reference material (CRM) ensures the metrological traceability of the method. A reference value was allotted to the CRM together with its standard uncertainty u_{ref} . This standard uncertainty of the CRM is combined with the compound uncertainty for the method, u_{comp} , to determine the overall standard uncertainty of the laboratory method $u(x)$.

The overall standard uncertainty of the method adjusted with the CRM in question is therefore:

$$u(x) = \sqrt{u_{ref}^2 + u_{comp}^2}$$

NOTE 1 The methodology is identical in the case of methods adjusted with the results of an interlaboratory comparison chain.

NOTE 2 Note the difference between a CRM used to adjust the bias of a method, in which the uncertainty of its reference value combines with that of the method, and a CRM used to control a method adjusted by other means (cf. § 6.5.4.2). In the second case, the uncertainty of the CRM should not be used for the uncertainty assessment of the method.

7.4.3.3.2.2 Methods adjusted with several reference materials (gauging ranges etc.)

There is no particular adjustment of bias apart from gauging work.

It is clear that each calibrator introduces bias uncertainty. There is therefore an overall theoretical uncertainty of bias, which is a combination of the uncertainties

of each calibrator. This uncertainty is very delicate to estimate, but it generally proves to be sufficiently low to be ignored, in particular if the laboratory monitors the quality of its calibrators, and the uncertainty of their reference values.

Other than in specific cases, bias uncertainty is ignored here.

7.4.3.3.3 Matrix effect

7.4.3.3.3.1 Definition

The matrix effect incurs a repeatable source of error for a given sample, but random from one sample to another. This error is related to the interaction of the compounds present in the product to be analyzed on measuring the required analyte. The matrix effect appears in methods with a nonspecific signal.

The matrix effect often constitutes a small part of uncertainty, particularly in separative methods. In certain other methods, including the infra-red techniques, it is a significant component of uncertainty.

Example: Estimate of the matrix effect on FTIR

The signal for the FTIR, or infra-red spectrum, is not a signal specific to each of the compounds that are measured by this technique. The statistical gauging model can be used to process disturbed, nonspecific spectral data in a sufficiently exact estimate of the value of the measurand. This model integrates the influences of the other compounds of the wine, which vary from one wine to the next and introduce an error into the result. Upstream of the routine analysis work, special work is carried out by the gauging developers to minimize this matrix effect and to make gauging robust, i.e. capable of integrating these variations without reflecting them in the result. Nevertheless the matrix effect is always present and constitutes a source of error at the origin of a significant part of the uncertainty of an FTIR method.

To be completely rigorous, this matrix effect error can be estimated by comparing, on the one hand, the means for a great number of FTIR measurement replicas, obtained on several reference materials (at least 10), under reproducibility conditions, and the true values of reference materials with a natural wine matrix on the other. The standard deviation of the differences gives this variability of gauging (provided that the gauging has been adjusted beforehand (bias = 0)).

This theoretical approach cannot be applied in practice, because the true values are never known, but it is experimentally possible to come sufficiently close to it:

- As a preliminary, the FTIR gauging must be statistically adjusted (bias = 0) in relation to a reference method based on at least 30 samples. This can be used to eliminate the effects of bias in the measurements thereafter.
- The reference materials must be natural wines. It is advisable to use at least 10 different reference materials, with values located inside a range level, the uncertainty of which can be considered to be constant.
- An acceptable reference value is acquired, based on the mean of several measurements by the reference method, carried out under reproducibility conditions. This can be used to lower the uncertainty of the reference value: if, for the reference method used, all the significant sources of uncertainty range within reproducibility conditions, the multiplication of the number p of measurements carried out under reproducibility conditions, enable the uncertainty associated with their mean to be divided by \sqrt{p} . The mean obtained using a sufficient number of measurements will then have a low level of uncertainty, even negligible in relation to the uncertainty of the alternative method; and can therefore be used as a reference value. p must at least be equal to 5.
- The reference materials are analyzed by the FTIR method, with several replicas, acquired under reproducibility conditions. By multiplying the number of measurements q under reproducibility conditions on the FTIR method, the variability related to the precision of the method (random error) can be decreased. The mean value of these measurements will have a standard deviation of variability divided by \sqrt{q} . This random error can then become negligible in relation to the variability linked to the gauging (matrix effect) that we are trying to estimate. q must at least be equal to 5.

COMPENDIUM OF INTERNATIONAL ANALYSIS OF METHODS - OIV
Guide for the validation – quality control

The following example is applied to the determination of acetic acid by FTIR gauging. The reference values are given by 5 measurements under reproducibility conditions on 7 stable test materials. The number of 7 materials is in theory insufficient, but the data here are only given by way of an example.

Materials	Reference method					Mean Ref	FTIR					Mean FTIR	Diff
	1	2	3	4	5		1	2	3	4	5		
1	0.3	0.3	0.3	0.3	0.3	0.30	0	0.3	0.3	0.3	0.3	0.305	-0.004
2	0.3	0.3	0.3	0.3	0.3	0.31	0	0.3	0.3	0.3	0.3	0.315	-0.006
3	0.3	0.3	0.3	0.3	0.3	0.38	0	0.3	0.3	0.3	0.3	0.37	-0.016
4	0.2	0.2	0.2	0.2	0.2	0.24	0	0.2	0.2	0.2	0.2	0.26	0.01
5	0.3	0.3	0.4	0.4	0.3	0.39	0	0.4	0.4	0.4	0.4	0.425	0.03
6	0.2	0.2	0.2	0.2	0.2	0.26	0	0.2	0.2	0.2	0.2	0.255	-0.008
7	0.3	0.3	0.3	0.3	0.3	0.36	0	0.3	0.3	0.3	0.3	0.365	-0.008

Calculation of the differences: $diff = Mean\ FTIR - Mean\ ref.$

The mean of the differences $M_d = 0.000$ verifies (good adjustment of the FTIR compared with the reference method)

The standard deviation of the differences, $S_d = 0.015$. It is this standard deviation that is used to estimate the variability generated by the gauging, and we can therefore state that:

$$U_f = 0.015$$

NOTE It should be noted that the value of U_f can be over-estimated by this approach. If the laboratory considers that the value is significantly excessive under the operating conditions defined here, it can increase the number of measurements on the reference method and/or the FTIR method.

The reproducibility conditions include all the other significant sources of error, S_R was otherwise calculated:
 $SR = 0.017$

The uncertainty of the determination of acetic acid by this FTIR application is:

$$+/-2*\sqrt{0.015^2+0.017^2} \text{ or } +/- 0.045 \text{ g.L}^{-1}$$

7.4.3.3.4 Sample effect

In certain cases, the experiment schedules used to estimate uncertainty are based on synthetic test materials. In such a situation, the estimate does not cover the sample effect (homogeneity). The laboratories must therefore estimate this effect.

It should be noted, however, that this effect is often negligible in oenological laboratories, which use homogeneous samples of small quantities.

7.4.4 Estimating standard uncertainty by interlaboratory tests

7.4.4.1 Principle

The interlaboratory approach uses data output by interlaboratory tests from which a standard deviation of interlaboratory reproducibility is calculated, in accordance with the principles indicated in §5.4.3. The statisticians responsible for calculating the results of the interlaboratory tests can identify "aberrant" laboratory results, by using tests described in the ISO 5725 standard (Cochran test). These results can then be eliminated after agreement between the statisticians and the analysts.

For the uncertainty assessment by interlaboratory approach, the guidelines stated in the ISO 21748 standard are as follows:

1. The reproducibility standard deviation (interlaboratory) obtained in a collaborative study is a valid basis for evaluating the uncertainty of measurement
2. Effects that are not observed as part of the collaborative study must be obviously negligible or be explicitly taken into account.

There are two types of interlaboratory tests:

1. Collaborative studies which relate to only one method. These studies are carried out for the initial validation of a new method in order to define the standard deviation of interlaboratory reproducibility SR_{inter} (*method*).
2. Interlaboratory comparison chains, or aptitude tests. These tests are carried out to validate a method adopted by the laboratory, and the routine quality control (see § 5.3.3.3). The data are processed as a whole, and integrate all the analysis methods employed by the laboratories participating in the tests. The results are the interlaboratory mean m , and the standard deviation of interlaboratory and intermethod reproducibility SR_{inter} .

7.4.4.2 Using the standard deviation of interlaboratory and intramethod reproducibility SR_{inter} (method)

The standard deviation of intralaboratory reproducibility SR_{inter} (*method*) takes into account intralaboratory variability and the overall interlaboratory variability related to the method.

Then must be taken into account the fact that the analysis method can produce a systematic bias compared with the true value.

As part of a collaborative study, whenever possible, the error produced by this bias can be estimated by using certified reference materials, under the same conditions as described in § 7.4.3.3.2, and added to SR_{inter} (*method*).

7.4.4.3 Using the standard deviation of interlaboratory and intermethod reproducibility SR_{inter}

The standard deviation of intralaboratory reproducibility SR_{inter} takes into account intralaboratory variability and interlaboratory variability for the parameter under study.

The laboratory must check its accuracy in relation to these results (see § 5.3.3).

There is no need to add components associated with method accuracy to the uncertainty budget, since in the "multi-method" aptitude tests, errors of accuracy can be considered to be taken into account in SR_{inter} .

7.4.4.4 Other components in the uncertainty budget

Insofar as the test materials used for the interlaboratory tests are representative of the conventional samples analyzed by laboratories, and that they follow the overall analytical procedure (sub-sampling, extraction, concentration, dilution, distillation etc.), $S_{R-inter}$ represents the standard uncertainty $u(x)$ of the method, in the interlaboratory sense.

Errors not taken into account in the interlaboratory tests must then be studied in order to assess their compound standard uncertainty, which will be combined with the compound standard uncertainty of the interlaboratory tests.

7.5 Expressing expanded uncertainty

In practice, uncertainty is expressed in its expanded form, in absolute terms for methods in which uncertainty is stable in the scope in question, or relative when uncertainty varies proportionally in relation to the quantity of the measurand:

Absolute uncertainty: $U = +/- 2u(x)$

Relative uncertainty (in %): $U = +/- \frac{2u(x)}{\bar{x}} \cdot 100$

where \bar{x} mean represents the reproducibility results.

NOTE This expression of uncertainty is possible given the assumption that the variations obey a normal law with a 95% confidence rate.

These expressions result in a given uncertainty value with a confidence level of **95%**.

REFERENCES

- (1) **OIV, 2001** – Recueil des methods internationales d’analyse des vins and des mouûts; *OIV Ed., Paris.*
- (2) **OIV, 2002** – Recommandations harmonisées pour le contrôle interne de qualité dans les laboratoires d’analyse; *OIV resolution æno 19/2002., Paris.*
- (3) **Standard ISO 5725: 1994** – Exactitude (justesse and fidélité) des results and methods de mesure, *classification index X 06-041-1*
- (4) **IUPAC, 2002** – Harmonized guidelines for single-laboratory validation of analysis methods; *Pure Appl. Chem., Vol. 74; n°5, pp. 835-855.*
- (5) **Standard ISO 11095: 1996** – Etalonnage linéaire utilisant des materials de référence, *reference number ISO 11095:1996*
- (6) **Standard ISO 21748: 2004** – Lignes directrices relatives à l’utilisation d’estimation de la répétabilité, de la reproductibilité and de la justesse dans l’évaluation de l’incertitude de mesure, *reference number ISO ISO/TS 21748:2004*
- (7) **Standard AFNOR V03-110: 1998** – Procédure de validation intralaboratory d’une method alternative par rapport à une method de référence, *classification index V03-110*
- (8) **Standard AFNOR V03-115: 1996** – Guide pour l’utilisation des materials de référence, *classification index V03-115*
- (9) **Standard AFNOR X 07-001: 1994** – Vocabulaire international des termes fondamentaux and généraux de métrologie, *classification index X07-001*
- (10) **Standard AFNOR ENV 13005: 1999** – Guide pour l’expression de l’incertitude de mesure
- (11) **AFNOR, 2003**, - Métrologie dans l’entreprise, outil de la qualité 2^{ème} édition, *AFNOR 2003 edition*
- (12) **EURACHEM, 2000**. - Quantifying Uncertainty in Analytical Measurement, *EURACHEM second edition 2000*
- (13) **CITAC / EURACHEM, 2000** - Guide pour la qualité en chimie analytique, *EURACHEM 2002 edition*

(14) Bouvier J.C., 2002 - Calcul de l'incertitude de mesure – Guide pratique pour les laboratoires d'analyse œnologique, *Revue Française d'œnologie no.197, Nov-Dec 2002, pp: 16-21*

(15) Snakkers G. and Cantagrel R., 2004 - Utilisation des données des circuits de comparaison interlaboratoires pour apprécier l'exactitude des results d'un laboratoire Estimation d'une incertitude de mesure - *Bull OIV, Vol. 77 857-876, Jan – Feb 2004, pp: 48-83*

(16) Perruchet C. and Priel M., 2000 - Estimer l'incertitude, *AFNOR Editions*

(17) Neuilly (M.) and CETAMA, 1993 - Modélisation and estimation des errors de mesures, *Lavoisier Ed, Paris*

COMPENDIUM OF INTERNATIONAL ANALYSIS OF METHODS - OIV
Guide for the validation – quality control

Annex N°1

Table A - Law of SNEDECOR

This table indicates values of **F** in function with **v₁** and **v₂** for a risk **α** of 0,05

P=0,950

v₁ v₂	1	2	3	4	5	6	7	8	9	10	v₁ v₂
1	161,4	199,5	215,7	224,6	230,2	234,0	236,8	238,9	240,5	241,9	1
2	18,51	19,00	19,16	19,25	19,30	19,33	19,35	19,37	19,38	19,40	2
3	10,13	9,55	9,28	9,12	9,01	8,94	8,89	8,85	8,81	8,79	3
4	7,71	6,94	6,59	6,39	6,26	6,16	6,09	6,04	6,00	5,96	4
5	6,61	5,79	5,41	5,19	5,05	4,95	4,88	4,82	4,77	4,74	5
6	5,99	5,14	4,76	4,53	4,39	4,28	4,21	4,15	4,10	4,06	6
7	5,59	4,74	4,35	4,12	3,97	3,87	3,79	3,73	3,68	3,64	7
8	5,32	4,46	4,07	3,84	3,69	3,58	3,50	3,44	3,39	3,35	8
9	5,12	4,26	3,86	3,63	3,48	3,37	3,29	3,23	3,18	3,14	9
10	4,96	4,10	3,71	3,48	3,33	3,22	3,14	3,07	3,02	2,98	10
11	4,84	3,98	3,59	3,36	3,20	3,09	3,01	2,95	2,90	2,85	11
12	4,75	3,89	3,49	3,26	3,11	3,00	2,91	2,85	2,80	2,75	12
13	4,67	3,81	3,41	3,18	3,03	2,92	2,83	2,77	2,71	2,67	13
14	4,60	3,74	3,34	3,11	2,96	2,85	2,76	2,70	2,65	2,60	14
15	4,54	3,68	3,29	3,06	2,90	2,79	2,71	2,64	2,59	2,54	15
16	4,49	3,63	3,24	3,01	2,85	2,74	2,66	2,59	2,54	2,49	16
17	4,45	3,59	3,20	2,96	2,81	2,70	2,61	2,55	2,49	2,45	17
18	4,41	3,55	3,16	2,93	2,77	2,66	2,58	2,51	2,46	2,41	18
19	4,38	3,52	3,13	2,90	2,74	2,63	2,54	2,48	2,42	2,38	19
20	4,35	3,49	3,10	2,87	2,71	2,60	2,51	2,45	2,39	2,35	20
21	4,32	3,47	3,07	2,84	2,68	2,57	2,49	2,42	2,37	2,32	21
22	4,30	3,44	3,05	2,82	2,66	2,55	2,46	2,40	2,34	2,30	22
23	4,28	3,42	3,03	2,80	2,64	2,53	2,44	2,37	2,32	2,27	23
24	4,26	3,40	3,01	2,78	2,62	2,51	2,42	2,36	2,30	2,25	24
25	4,24	3,39	2,99	2,76	2,60	2,49	2,40	2,34	2,28	2,24	25
26	4,23	3,37	2,98	2,74	2,59	2,47	2,39	2,32	2,27	2,22	26
27	4,21	3,35	2,96	2,73	2,57	2,46	2,37	2,31	2,25	2,20	27
28	4,20	3,34	2,95	2,71	2,56	2,45	2,36	2,29	2,24	2,19	28
29	4,18	3,33	2,93	2,70	2,55	2,43	2,35	2,28	2,22	2,18	29
30	4,17	3,32	2,92	2,69	2,53	2,42	2,33	2,27	2,21	2,16	30
40	4,08	3,23	2,84	2,61	2,45	2,34	2,25	2,18	2,12	2,08	40
60	4,00	3,15	2,76	2,53	2,37	2,25	2,17	2,10	2,04	1,99	60
120	3,92	3,07	2,68	2,45	2,29	2,17	2,09	2,02	1,96	1,91	120
∞	3,84	3,00	2,60	2,37	2,21	2,10	2,01	1,94	1,88	1,83	∞
v₂ v₁	1	2	3	4	5	6	7	8	9	10	v₂ v₁

COMPENDIUM OF INTERNATIONAL ANALYSIS OF METHODS - OIV
Guide for the validation – quality control

Annex N°2

Table B - Law of STUDENT

This table indicates values of **t** in function with **P** and **v**.

7.5.1.1. v	0,55	0,60	0,65	0,70	0,75	0,80	0,85	0,90	0,95	0,975	0,990	0,995	0,9995	P v
1	0,158	0,325	0,510	0,727	1,000	1,376	1,963	3,078	6,314	12,706	31,821	63,657	636,619	1
2	0,142	0,289	0,445	0,617	0,816	1,061	1,386	1,886	2,920	4,303	6,965	9,925	31,598	2
3	0,137	0,277	0,424	0,584	0,765	0,978	1,250	1,638	2,353	3,182	4,541	5,841	12,929	3
4	0,134	0,271	0,414	0,569	0,741	0,941	1,190	1,533	2,132	2,776	3,747	4,604	8,610	4
5	0,132	0,267	0,408	0,559	0,727	0,920	1,156	1,476	2,015	2,571	3,365	4,032	6,869	5
6	0,131	0,265	0,404	0,553	0,718	0,906	1,134	1,440	1,943	2,447	3,143	3,707	5,959	6
7	0,130	0,263	0,402	0,549	0,711	0,896	1,119	1,415	1,895	2,365	2,998	3,499	5,408	7
8	0,130	0,262	0,399	0,546	0,706	0,889	1,108	1,397	1,860	2,306	2,896	3,355	5,041	8
9	0,129	0,261	0,398	0,543	0,703	0,883	1,100	1,383	1,833	2,262	2,821	3,250	4,781	9
10	0,129	0,260	0,397	0,542	0,700	0,879	1,093	1,372	1,812	2,228	2,764	3,169	4,587	10
11	0,129	0,260	0,396	0,540	0,697	0,876	1,088	1,363	1,796	2,201	2,718	3,106	4,437	11
12	0,128	0,259	0,395	0,539	0,695	0,873	1,083	1,356	1,782	2,179	2,681	3,055	4,318	12
13	0,128	0,259	0,394	0,538	0,694	0,870	1,079	1,350	1,771	2,160	2,650	3,012	4,221	13
14	0,128	0,258	0,393	0,537	0,692	0,868	1,076	1,345	1,761	2,145	2,624	2,977	4,140	14
15	0,128	0,258	0,393	0,536	0,691	0,866	1,074	1,341	1,753	2,131	2,602	2,947	4,073	15
16	0,128	0,258	0,392	0,535	0,690	0,865	1,071	1,337	1,746	2,120	2,583	2,921	4,015	16
17	0,128	0,257	0,392	0,534	0,689	0,863	1,069	1,333	1,740	2,110	2,567	2,898	3,965	17
18	0,127	0,257	0,392	0,534	0,688	0,862	1,067	1,330	1,734	2,101	2,552	2,878	3,922	18
19	0,127	0,257	0,391	0,533	0,688	0,861	1,066	1,328	1,729	2,093	2,539	2,861	3,883	19
20	0,127	0,257	0,391	0,533	0,687	0,860	1,064	1,325	1,725	2,086	2,528	2,845	3,850	20
21	0,127	0,257	0,391	0,532	0,686	0,859	1,063	1,323	1,721	2,080	2,518	2,831	3,819	21
22	0,127	0,256	0,390	0,532	0,686	0,858	1,061	1,321	1,717	2,074	2,508	2,819	3,792	22
23	0,127	0,256	0,390	0,532	0,685	0,858	1,060	1,319	1,714	2,069	2,500	2,807	3,767	23
24	0,127	0,256	0,390	0,531	0,685	0,857	1,059	1,318	1,711	2,064	2,492	2,797	3,745	24
25	0,127	0,256	0,390	0,531	0,684	0,856	1,058	1,316	1,708	2,060	2,485	2,787	3,725	25
26	0,127	0,256	0,390	0,531	0,684	0,856	1,058	1,315	1,706	2,056	2,479	2,779	3,707	26
27	0,127	0,256	0,389	0,531	0,684	0,855	1,057	1,314	1,703	2,052	2,473	2,771	3,690	27
28	0,127	0,256	0,389	0,530	0,683	0,855	1,056	1,313	1,701	2,048	2,467	2,763	3,674	28
29	0,127	0,256	0,389	0,530	0,683	0,854	1,055	1,311	1,699	2,045	2,462	2,756	3,659	29
30	0,127	0,256	0,389	0,530	0,683	0,854	1,055	1,310	1,697	2,042	2,457	2,750	3,646	30
40	0,126	0,255	0,388	0,529	0,681	0,851	1,050	1,303	1,684	2,021	2,423	2,704	3,551	40
60	0,126	0,254	0,387	0,527	0,679	0,848	1,046	1,296	1,671	2,000	2,390	2,660	3,460	60
120	0,126	0,254	0,386	0,526	0,677	0,845	1,041	1,289	1,658	1,980	2,358	2,617	3,373	120
∞	0,126	0,253	0,385	0,524	0,674	0,842	1,036	1,282	1,645	1,960	2,326	2,576	3,291	∞
v P	0,55	0,60	0,65	0,70	0,75	0,80	0,85	0,90	0,95	0,975	0,990	0,995	0,9995	P v

**Harmonised guidelines for single-laboratory validation of
methods of analysis (technical report)**

(Resolution Oeno 8/2005)

Synopsis

Method validation is one of the measures universally recognised as a necessary part of a comprehensive system of quality assurance in analytical chemistry. In the past ISO, IUPAC and AOAC INTERNATIONAL have co-operated to produce agreed protocols or guidelines on the “Design, Conduct and Interpretation of Method Performance Studies”¹ on the “Proficiency Testing of (Chemical) Analytical Laboratories”² on “Internal Quality Control in Analytical Chemistry Laboratories”³ and on “The Use of Recovery Information in Analytical Measurement”⁴ (from the usage of overlapping data in analytical measurements) The Working Group that produced these protocols/guidelines has now been mandated by IUPAC to prepare guidelines on the Single-laboratory Validation of methods of analysis. These guidelines provide minimum recommendations on procedures that should be employed to ensure adequate validation of analytical methods.

A draft of the guidelines has been discussed at an International Symposium on the Harmonisation of Quality Assurance Systems in Chemical Laboratory, the Proceedings from which have been published by the UK Royal Society of Chemistry.

Resulting from the Symposium on Harmonisation of Quality Assurance
Systems for Analytical Laboratories, Budapest, Hungary, 4-5 November 1999
held under the sponsorship of IUPAC, ISO and AOAC INTERNATIONAL

CONTENTS

1	INTRODUCTION
1.1	Background
1.2	Existing protocols, standards and guides
2	DEFINITIONS AND TERMINOLOGY
2.1	General
2.2	Definitions used in this guide
3	Method validation, uncertainty, and quality assurance
4	BASIC PRINCIPLES OF METHOD VALIDATION
4.1	Specification and scope of validation
4.2	Testing assumptions
4.3	Sources of Error in Analysis
4.4	Method and Laboratory effects
5	Conduct of Validation Studies
6	Extent of validation studies
6.1	The laboratory is to use a “fully” validated method
6.2	The laboratory is to use a fully validated method, but new matrix is to be used
6.3	The laboratory is to use a well-established, but not collaboratively studied, method
6.4	The method has been published in the scientific literature together with some analytical characteristics
6.5	The method has been published in the scientific literature with no characteristics given or has been developed in-house
6.6	The method is empirical
6.7	The analysis is “ad hoc”
6.8	Changes in staff and equipment
7	RECOMMENDATIONS
8	BIBLIOGRAPHY

ANNEX A: NOTES ON THE REQUIREMENTS FOR STUDY OF METHOD PERFORMANCE CHARACTERISTICS.

- A1 Applicability
- A2 Selectivity
- A3 Calibration and linearity
 - A3.1 Linearity and intercept*
 - A3.2 Test for general matrix effect*
 - A3.3 Final calibration procedure*
- A4 Trueness
 - A4.1 Estimation of trueness*
 - A4.2 Conditions for trueness experiments*
 - A4.3 Reference values for trueness experiments*
 - A4.3.1 Certified reference materials (CRMs)*
 - A4.3.2 Reference materials
 - A4.3.3 Use of a reference method
 - A4.3.4 Use of spiking/recovery
- A5 Accuracy
- A6 Recovery
- A7 Concentration range
- A8 Detection Limit
- A9 Limit of determination or limit of quantification
- A10 Sensitivity
- A11 Ruggedness
- A12 Fitness for trial purposes
- A13 Matrix variation
- A14. Measurement Uncertainty

ANNEX B. ADDITIONAL CONSIDERATIONS FOR UNCERTAINTY
ESTIMATION IN VALIDATION STUDIES

B1 Sensitivity analysis

B2 Judgement

1. INTRODUCTION

1.1 Background

Reliable analytical methods are required for compliance with national and international regulations in all areas of analysis. It is accordingly internationally recognised that a laboratory must take appropriate measures to ensure that it is capable of providing and does provide data of the required quality. Such measures include:

- using validated methods of analysis;
- using internal quality control procedures;
- participating in proficiency testing schemes; and
- becoming accredited to an International Standard, normally ISO/IEC 17025.

It should be noted that accreditation to ISO/IEC 17025 specifically addresses the establishment of traceability for measurements, as well as requiring a range of other technical and management requirements including all those in the list above.

Method validation is therefore an essential component of the measures that a laboratory should implement to allow it to produce reliable analytical data. Other aspects of the above have been addressed previously by the IUPAC Interdivisional Working Party on Harmonisation of Quality Assurance Schemes for Analytical Laboratories, specifically by preparing Protocols/Guidelines on method performance (collaborative) studies,¹ proficiency testing,² and internal quality control.³

In some sectors, most notably in the analysis of food, the requirement for methods that have been “fully validated” is prescribed by legislation.^{5,6} “Full” validation for an analytical method is usually taken to comprise an examination of the characteristics of the method in an inter-laboratory method performance study (also known as a collaborative study or collaborative trial). Internationally accepted protocols have been established for the “full” validation of a method of analysis by a collaborative trial, most notably the International Harmonised Protocol¹ and the ISO procedure.⁷ These protocols/standards require a minimum number of laboratories and test materials to be included in the collaborative trial to validate fully the analytical method. However, it is not always practical or necessary to provide full validation of analytical methods. In such circumstances a “single-laboratory method validation” may be appropriate.

Single-laboratory method validation is appropriate in several circumstances including the following:

- to ensure the viability of the method before the costly exercise of a formal collaborative trial;
- to provide evidence of the reliability of analytical methods if collaborative trial data are not available or where the conduct of a formal collaborative trial is not practicable;
- to ensure that “off-the-shelf” validated methods are being used correctly.

When a method is to be characterised in-house, it is important that the laboratory determines and agrees with its customer exactly which characteristics are to be evaluated. However, in a number of situations these characteristics may be laid down by legislation (e.g. veterinary drug residues in food and pesticides in food sectors). The extent of the evaluation that a laboratory undertakes must meet the requirements of legislation.

Nevertheless in some analytical areas the same analytical method is used by a large number of laboratories to determine stable chemical compounds in defined matrices. It should be appreciated that if a suitable collaboratively studied method can be made available to these laboratories, then the costs of the collaborative trial to validate that method may well be justified. The use of a collaboratively studied method considerably reduces the efforts which a laboratory, before taking a method into routine use, must invest in extensive validation work. A laboratory using a collaboratively studied method, which has been found to be fit for the intended purpose, needs only to demonstrate that it can achieve the performance characteristics stated in the method. Such a verification of the correct use of a method is much less costly than a full single laboratory validation. The total cost to the Analytical Community of validating a specific method through a collaborative trial and then verifying its performance attributes in the laboratories wishing to use it is frequently less than when many laboratories all independently undertake single laboratory validation of the same method.

1.2 Existing Protocols, Standards and Guides

A number of protocols and guidelines⁸⁻¹⁹ on method validation and uncertainty have been prepared, most notably in AOAC INTERNATIONAL, International Conference on Harmonisation (ICH) and Eurachem documents:

- The Statistics manual of the AOAC, which includes guidance on single laboratory study prior to collaborative testing¹³

- The ICH text¹⁵ and methodology,¹⁶ which prescribe minimum validation study requirements for tests used to support drug approval submission.
- The Fitness for Purpose of Analytical Methods: A Laboratory Guide to Method Validation and Related Topics (1998)¹²
- Quantifying Uncertainty in Analytical Measurement (2000)⁹

Method validation was also extensively discussed at a Joint FAO/IAEA Expert Consultation, December 1997, on the Validation of Analytical Methods for Food Controls, the Report of which is available¹⁹.

The present 'Guidelines' bring together the essential scientific principles of the above documents to provide information which has been subjected to international acceptance and, more importantly, to point the way forward for best practice in single-laboratory method validation.

2 DEFINITIONS AND TERMINOLOGY

2.1 General

Terms used in this document respect ISO and IUPAC definitions where available. The following documents contain relevant definitions:

- i) IUPAC: Compendium of chemical terminology, 1987
- ii) International vocabulary of basic and general terms in metrology. ISO 1993

2.2 Definitions used in this guide only:

Relative uncertainty: Uncertainty expressed as a relative standard deviation.

Validated range: That part of the concentration range of an analytical method which has been subjected to validation.

3 METHOD VALIDATION, UNCERTAINTY, AND QUALITY ASSURANCE

Method validation makes use of a set of tests which both test any assumptions on which the analytical method is based and establish and document the performance characteristics of a method, thereby demonstrating whether the method is fit for a particular analytical purpose. Typical performance characteristics of analytical methods are: applicability; selectivity; calibration; trueness; precision; recovery; operating range; limit of quantification; limit of detection; sensitivity; and ruggedness. To these can be added measurement uncertainty and fitness-for-purpose.

Strictly speaking, validation should refer to an ‘analytical system’ rather than an ‘analytical method’, the analytical system comprising a defined method protocol, a defined concentration range for the analyte, and a specified type of test material. For the purposes of this document, a reference to ‘method validation’ will be taken as referring to an analytical system as a whole. Where the analytical procedure as such is addressed, it will be referred to as ‘the protocol’.

In this document method validation is regarded as distinct from ongoing activities such as internal quality control (IQC) or proficiency testing. Method validation is carried out once, or at relatively infrequent intervals during the working lifetime of a method; it tells us what performance we can expect the method to provide in the future. Internal quality control tells us about how the method has performed in the past. IQC is therefore treated as a separate activity in the IUPAC Harmonisation Programme.³

In method validation the quantitative characteristics of interest relate to the accuracy of the result likely to be obtained. Therefore it is generally true to say that method validation is tantamount to the task of estimating uncertainty of measurement. Over the years it has become traditional for validation purposes to represent different aspects of method performance by reference to the separate items listed above, and to a considerable extent these guidelines reflect that pattern. However, with an increasing reliance on measurement uncertainty as a key indicator of both fitness for purpose and reliability of results, analytical chemists will increasingly undertake measurement validation to support uncertainty estimation, and some practitioners will want to do so immediately. Accordingly, measurement uncertainty is treated briefly in Annex A as a performance characteristic of an analytical method, while Annex B provides additional guidance on some procedures not otherwise covered.

4 BASIC PRINCIPLES OF METHOD VALIDATION

4.1 Specification and scope of validation

Validation applies to a defined protocol, for the determination of a specified analyte and range of concentrations in a particular type of test material, used for a specified purpose. In general, validation should check that the method performs adequately for the purpose throughout the range of analyte concentrations and test materials to which it is applied. It follows that these features, together with a statement of any fitness-for-purpose criteria, should be completely specified before any validation takes place.

4.2 Testing assumptions

In addition to the provision of performance figures which indicate fitness for purpose and have come to dominate the practical use of validation data, validation studies act as an objective test of any assumptions on which an analytical method is based. For example, if a result is to be calculated from a simple straight line calibration function, it is implicitly assumed that the analysis is free from significant bias, that the response is proportional to analyte concentration, and that the dispersion of random errors is constant throughout the range of interest. In most circumstances, such assumptions are made on the basis of experience accumulated during method development or over the longer term, and are consequently reasonably reliable. Nonetheless, good measurement science relies on *tested* hypotheses. This is the reason that so many validation studies are based on statistical hypothesis testing; the aim is to provide a basic check that the reasonable assumptions made about the principles of the method are not seriously flawed.

There is an important practical implication of this apparently abstruse note. It is easier to check for gross departure from a reliable assumption than to 'prove' that a particular assumption is correct. Thus, where there is long practice of the successful use of a particular analytical technique (such as gas chromatographic analysis, or acid digestion methods) across a range of analytes and matrices, validation checks justifiably take the form of relatively light precautionary tests. Conversely, where experience is slight, the validation study needs to provide strong evidence that the assumptions made are appropriate in the particular cases under study, and it will generally be necessary to study the full range of circumstances in detail. It follows that the extent of validation studies required in a given instance will depend, in part, on the accumulated experience of the analytical technique used.

In the following discussion, it will be taken for granted that the laboratory is well

practised in the technique of interest, and that the purpose of any significance tests is to check that there is no strong evidence to discount the assumptions on which the particular protocol relies. The reader should bear in mind that more stringent checks may be necessary for unfamiliar or less established measurement techniques.

4.3 Sources of Error in Analysis

Errors in analytical measurements arise from different sources* and at different levels of organisation. One useful way of representing these sources (for a specific concentration of analyte) is as follows⁺²⁴:

- random error of measurement (repeatability);
- run bias ;
- laboratory bias;
- method bias;
- matrix variation effect.

Though these different sources may not necessarily be independent, this list provides a useful way of checking the extent to which a given validation study addresses the sources of error.

The repeatability (within-run) term includes contributions from any part of the procedure that varies within a run, including contributions from the familiar gravimetric and volumetric errors, heterogeneity of the test material, and variation in the chemical treatment stages of the analysis, and is easily seen in the dispersion of replicated analyses. The run effect accounts for additional day-to-day variations in the analytical system, such as changes of analyst, batches of reagents, recalibration of instruments, and the laboratory environment (*e.g.*, temperature changes). In single-laboratory validation, the run effect is typically estimated by

* Sampling uncertainty in the strict sense of uncertainty due to the preparation of the laboratory sample from the bulk target is excluded from consideration in this document. Uncertainty associated with taking a test portion from the laboratory sample is an inseparable part of measurement uncertainty and is automatically included at various levels of the following analysis.

⁺ Many alternative groupings or ‘partitions of error’ are possible and may be useful in studying particular sources of error in more detail or across a different range of situations. For example, the statistical model of ISO 5725 generally combines laboratory and run effects, while the uncertainty estimation procedure in the ISO GUM is well suited to assessing the effects of each separate and measurable influence on the result.

conducting a designed experiment with replicated analysis of an appropriate material in a number of separate runs. Between-laboratory variation arises from factors such as variations in calibration standards, differences between local interpretations of a protocol, changes in equipment or reagent source or environmental factors, such as differences in average climatic conditions. Between-laboratory variation is clearly seen as a reality in the results of collaborative trials (method performance studies) and proficiency tests, and between-method variation can sometimes be discerned in the results of the latter.

Generally, the repeatability, run effect and laboratory effect are of comparable magnitude, so none can safely be ignored in validation. In the past there has been a tendency for aspects to be neglected, particularly when estimating and reporting uncertainty information. This results in uncertainty intervals that are too tight. For example, the collaborative trial as normally conducted does not give the complete picture because contributions to uncertainty from method bias and matrix variation are not estimated in collaborative trials and have to be addressed separately (usually by prior single-laboratory study). In single-laboratory validation there is the particular danger that laboratory bias also may be overlooked, and that item is usually the largest single contributor to uncertainty from the above list. Therefore specific attention must be paid to laboratory bias in single-laboratory validation.

In addition to the above-mentioned problems, the validation of a method is limited to the scope of its application, that is, the method as applied to a particular class of test material. If there is a substantial variation of matrix types within the defined class, there will be an additional source of variation due to within-class matrix effects. Of course, if the method is subsequently used for materials outside the defined class (that is, outside the scope of the validation), the analytical system cannot be considered validated: an extra error of unknown magnitude is introduced into the measurement process.

It is also important for analysts to take account of the way in which method performance varies as a function of the concentration of the analyte. In most instances the dispersion of results increases absolutely with concentration and recovery may differ substantially at high and low concentrations. The measurement uncertainty associated with the results is therefore often dependent on both these effects and on other concentration-dependent factors. Fortunately, it is often reasonable to assume a simple relationship between performance and analyte concentration; most commonly that errors are proportional to analyte concentration.* However, where the performance of the method is of interest at

* This may not be applicable at concentrations less than 10 times the detection limit.

substantially different concentrations, it is important to check the assumed relationship between performance and analyte concentration. This is typically done by checking performance at extremes of the likely range, or at a few selected levels. Linearity checks also provide information of the same kind.

4.4 Method and Laboratory effects

It is critically important in single-laboratory method validation to take account of method bias and laboratory bias. There are a few laboratories with special facilities where these biases can be regarded as negligible, but that circumstance is wholly exceptional. (However, that if there is only one laboratory carrying out a particular analysis, then method bias and laboratory bias take on a different perspective). Normally, method and laboratory effects have to be included in the uncertainty budget, but often they are more difficult to address than repeatability error and the run effect. In general, to assess the respective uncertainties it is necessary to use information gathered independently of the laboratory. The most generally useful sources of such information are (i) statistics from collaborative trials (not available in many situations of single-laboratory method validation), (ii) statistics from proficiency tests and (iii) results from the analysis of certified reference materials.

Collaborative trials directly estimate the variance of between-laboratory biases. While there may be theoretical shortcomings in the design of such trials, these variance estimates are appropriate for many practical purposes. Consequently it is always instructive to test single-laboratory validation by comparing the estimates of uncertainty with reproducibility estimates from collaborative trials. If the single-laboratory result is substantially the smaller, it is likely that important sources of uncertainty have been neglected. (Alternatively, it may be that a particular laboratory in fact works to a smaller uncertainty than found in collaborative trials: such a laboratory would have to take special measures to justify such a claim.) If no collaborative trial has been carried out on the particular method/test material combination, an estimate of the reproducibility standard deviation σ_H at an analyte concentration c above about 120 ppb can usually be obtained from the Horwitz function, $\sigma_H = 0.02c^{0.8495}$, with both variables expressed as mass fractions. (The Horwitz estimate is normally within a factor of about two of observed collaborative study results). It has been observed that the Horwitz function is incorrect at concentrations lower than about 120 ppb, and a modified function is more appropriate.^{21, 25} All of this information may be carried into the single-laboratory area with minimum change.

Statistics from proficiency tests are particularly interesting because they provide

information in general about the magnitude of laboratory and method biases combined and, for the participant, information about total error on specific occasions. Statistics such as the robust standard deviation of the participants results for an analyte in a round of the test can in principle be used in a way similar to reproducibility standard deviations from collaborative trials, *i.e.*, to obtain a benchmark for overall uncertainty for comparison with individual estimates from single-laboratory validation. In practice, statistics from proficiency tests may be more difficult to access, because they are not systematically tabulated and published like collaborative trials, but only made available to participants. Of course, if such statistics are to be used they must refer to the appropriate matrix and concentration of the analyte. Individual participants in proficiency testing schemes can also gauge the validity of their estimated uncertainty by comparing their reported results with the assigned values of successive rounds²⁶. This, however, is an ongoing activity and therefore not strictly within the purview of single-laboratory validation (which is a one-off event).

If an appropriate certified reference material is available, a single-laboratory test allows a laboratory to assess laboratory bias and method bias in combination, by analysing the CRM a number of times. The estimate of the combined bias is the difference between the mean result and the certified value.

Appropriate certified reference materials are not always available, so other materials may perforce have to be used. Materials left over from proficiency tests sometimes serve this purpose and, although the assigned values of the materials may have questionable uncertainties, their use certainly provides a check on overall bias. Specifically, proficiency test assigned values are generally chosen to provide a minimally biased estimate, so a test for significant bias against such a material is a sensible practice. A further alternative is to use spiking and recovery information⁴ to provide estimates of these biases, although there may be unmeasurable sources of uncertainty associated with these techniques.

Currently the least recognised effect in validation is that due to matrix variation within the defined class of test material. The theoretical requirement for the estimation of this uncertainty component is for a representative collection of test materials to be analysed in a single run, their individual biases estimated, and the variance of these biases calculated. (Analysis in a single run means that higher level biases have no effect on the variance. If there is a wide concentration range involved, then allowance for the change in bias with concentration must be made.) If the representative materials are certified reference materials, the biases can be estimated directly as the differences between the results and the reference values, and the whole procedure is straightforward. In the more likely event that insufficient number of certified reference materials are available, recovery tests with a range of typical test materials may be resorted to, with due caution.

Currently there is very little quantitative information about the magnitude of uncertainties from this source, although in some instances they are suspected of being large.

5 Conduct of Validation Studies

The detailed design and execution of method validation studies is covered extensively elsewhere and will not be repeated here. However, the main principles are pertinent and are considered below:

It is essential that validation studies are representative. That is, studies should, as far as possible, be conducted to provide a realistic survey of the number and range of effects operating during normal use of the method, as well as to cover the concentration ranges and sample types within the scope of the method. Where a factor (such as ambient temperature) has varied representatively at random during the course of a precision experiment, for example, the effects of that factor appear directly in the observed variance and need no additional study unless further method optimisation is desirable.

In the context of method validation, “representative variation” means that the factor must take a distribution of values appropriate to the anticipated range of the parameter in question. For continuous measurable parameters, this may be a permitted range, stated uncertainty or expected range; for discontinuous factors, or factors with unpredictable effects such as sample matrix, a representative range corresponds to the variety of types or “factor levels” permitted or encountered in normal use of the method. Ideally, representativeness extends not only to the range of values, but to their distribution. Unfortunately, it is often uneconomic to arrange for full variation of many factors at many levels. For most practical purposes, however, tests based on extremes of the expected range, or on larger changes than anticipated, are an acceptable minimum.

In selecting factors for variation, it is important to ensure that the larger effects are ‘exercised’ as much as possible. For example, where day to day variation (perhaps arising from recalibration effects) is substantial compared to repeatability, two determinations on each of five days will provide a better estimate of intermediate precision than five determinations on each of two days. Ten single determinations on separate days will be better still, subject to sufficient control, though this will provide no additional information on within-day repeatability.

Clearly, in planning significance checks, any study should have sufficient power to detect such effects before they become practically important (that is, comparable

to the largest component of uncertainty).

In addition, the following considerations may be important:

- Where factors are known or suspected to interact, it is important to ensure that the effect of interaction is accounted for. This may be achieved either by ensuring random selection from different levels of interacting parameters, or by careful systematic design to obtain 'interaction' effects or covariance information.
- In carrying out studies of overall bias, it is important that the reference materials and values are relevant to the materials under routine test.

6 Extent of validation studies

The extent to which a laboratory has to undertake validation of a new, modified or unfamiliar method depends to a degree on the existing status of the method and the competence of the laboratory. Suggestions as to the extent of validation and verification measures for different circumstances are given below. Except where stated, it is assumed that the method is intended for routine use.

6.1 The laboratory is to use a “fully” validated method

The method has been studied in a collaborative trial and so the laboratory has to verify that it is capable of achieving the published performance characteristics of the method (or is otherwise able to fulfil the requirements of the analytical task). The laboratory should undertake precision studies, bias studies (including matrix variation studies), and possibly linearity studies, although some tests such as that for ruggedness may be omitted.

6.2 The laboratory is to use a fully validated method, but new matrix is to be used

The method has been studied in a collaborative trial and so the laboratory has to verify that the new matrix introduces no new sources of error into the system. The same range of validation as the previous is required.

6.3 The laboratory is to use a well-established, but not collaboratively studied, method

The same range of validation as the previous is required.

6.4 The method has been published in the scientific literature together with some analytical characteristics

The laboratory should undertake precision studies, bias studies (including matrix variation studies), ruggedness and linearity studies.

6.5 The method has been published in the scientific literature with no characteristics given or has been developed in-house

The laboratory should undertake precision studies, bias studies (including matrix variation studies), ruggedness and linearity studies.

6.6 The method is empirical

An empirical method is one in which the quantity estimated is simply the result found on following the stated procedure. This differs from measurements intended to assess method-independent quantities such as the concentration of a particular analyte in a sample, in that the method bias is conventionally zero, and matrix variation (that is, within the defined class) is irrelevant. Laboratory bias cannot be ignored, but is likely to be difficult to estimate by single-laboratory experiment. Moreover, reference materials are unlikely to be available. In the absence of collaborative trial data some estimate of interlaboratory precision could be obtained from a specially designed ruggedness study or estimated by using the Horwitz function.

6.7 The analysis is “ad hoc”

“Ad hoc” analysis is occasionally necessary to establish the general range of a value, without great expenditure and with low criticality. The effort that can go into validation is accordingly strictly limited. Bias should be studied by methods such as recovery estimation or analyte additions, and precision by replication.

6.8 Changes in staff and equipment

Important examples include: change in major instruments; new batches of very variable reagents (for example, polyclonal antibodies); changes made in the laboratory premises; methods used for the first time by new staff; or a validated method employed after a period of disuse. Here the essential action is to demonstrate that no deleterious changes have occurred. The minimum check is a

single bias test; a “before and after” experiment on typical test materials or control materials. In general, the tests carried out should reflect the possible impact of the change on the analytical procedure.

7 RECOMMENDATIONS

The following recommendations are made regarding the use of single-laboratory method validation:

- Wherever possible and practical a laboratory should use a method of analysis that has had its performance characteristics evaluated through a collaborative trial conforming to an international protocol.
- Where such methods are not available, a method must be validated in-house before being used to generate analytical data for a customer.
- Single-laboratory validation requires the laboratory to select appropriate characteristics for evaluation from the following: applicability, selectivity, calibration, accuracy, precision, range, limit of quantification, limit of detection, sensitivity, ruggedness and practicability. The laboratory must take account of customer requirements in choosing which characteristics are to be determined.
- Evidence that these characteristics have been assessed must be made available to customers of the laboratory if required by the customer.

8 REFERENCES

1. *"Protocol for the Design, Conduct and Interpretation of Method Performance Studies"*, W Horwitz, *Pure Appl. Chem.*, 1988, **60**, 855-864, revised W. Horwitz, *Pure Appl. Chem.*, 1995, **67**, 331-343.
2. *"The International Harmonised Protocol for the Proficiency Testing of (Chemical) Analytical Laboratories"*, M Thompson and R Wood, *Pure Appl. Chem.*, 1993, **65**, 2123-2144. (Also published in *J. AOAC International*, 1993, **76**, 926-940.
3. *"Harmonised Guidelines For Internal Quality Control in Analytical Chemistry Laboratories"*, Michael Thompson and Roger Wood, *J. Pure & Applied Chemistry*, 1995, **67**(4), 49-56.
4. *"Harmonised Guidelines for the Use of Recovery Information in Analytical Measurement"*, Michael Thompson, Stephen Ellison, Ales Fajgelj, Paul Willetts and Roger Wood, *J. Pure & Applied Chemistry*, 1999, **71**(2), 337-348.

5. *“Council Directive 93/99/EEC on the Subject of Additional Measures Concerning the Official Control of Foodstuffs”*, O. J., 1993, L290.
6. *“Procedural Manual of the Codex Alimentarius Commission, 10th Edition”*, FAO, Rome, 1997.
7. *“Precision of Test Methods”*, Geneva, 1994, ISO 5725, Previous editions were issued in 1981 and 1986.
8. *“Guide to the Expression of Uncertainty in Measurement”*, ISO, Geneva, 1993.
9. *“Quantifying Uncertainty in Analytical Measurement”*, EURACHEM Secretariat, Laboratory of the Government Chemist, Teddington, UK, 1995, EURACHEM Guide (under revision).
10. *“International vocabulary of basic and general terms in metrology”* ISO, Geneva 1993
11. *“Validation of Chemical Analytical Methods”*, NMKL Secretariat, Finland, 1996, NMKL Procedure No. 4.
12. *“EURACHEM Guide: The fitness for purpose of analytical methods. A Laboratory Guide to method validation and related topics”*, LGC, Teddington 1996. Also available from the EURACHEM Secretariat and website.
13. *“Statistics manual of the AOAC”*, AOAC INTERNATIONAL, Gaithersburg, Maryland, USA, 1975
14. *“An Interlaboratory Analytical Method Validation Short Course developed by the AOAC INTERNATIONAL”*, AOAC INTERNATIONAL, Gaithersburg, Maryland, USA, 1996.
15. *“Text on validation of analytical procedures”* International Conference on Harmonisation. Federal Register, Vol. 60, March 1, 1995, pages 11260
16. *“Validation of analytical procedures: Methodology”* International Conference on Harmonisation. Federal Register, Vol. 62, No. 96, May 19, 1997, pages 27463-27467.

17. “*Validation of Methods*”, Inspectorate for Health Protection, Rijswijk, The Netherlands, Report 95-001.
18. “*A Protocol for Analytical Quality Assurance in Public Analysts’ Laboratories*”, Association of Public Analysts, 342 Coleford Road, Sheffield S9 5PH, UK, 1986.
19. “*Validation of Analytical Methods for Food Control*”, Report of a Joint FAO/IAEA Expert Consultation, December 1997, FAO Food and Nutrition Paper No. 68, FAO, Rome, 1998
20. “*Estimation and Expression of Measurement Uncertainty in Chemical Analysis*”, NMKL Secretariat, Finland, 1997, NMKL Procedure No. 5.
21. M Thompson, PJ Lowthian, *JAOAC Int*, 1997, **80**, 676-679
22. IUPAC recommendation: “*Nomenclature in evaluation of analytical methods, including quantification and detection capabilities*” *Pure and Applied Chem.* 1995, **67** 1699-1723
23. ISO 11843. “*Capability of detection.*” (Several parts). International Standards Organisation, Geneva.
24. M. Thompson, *Analyst*, 2000, **125**, 2020-2025
25. “*Recent trends in inter-laboratory precision at ppb and sub-ppb concentrations in relation to fitness for purpose criteria in proficiency testing*” M Thompson, *Analyst*, 2000, **125**, 385-386.
26. “*How to combine proficiency test results with your own uncertainty estimate - the zeta score*”, Analytical Methods Committee of the Royal Society of Chemistry, AMC Technical Briefs, editor M. Thompson, *AMC Technical Brief No. 2*, www.rsc.org/lap/rsccom/amc

ANNEX A: Notes on the requirements for study of method performance characteristics

The general requirements for the individual performance characteristics for a method are as follows.

A1 Applicability

After validation the documentation should provide, in addition to any performance specification, the following information:

- the identity of the analyte, including speciation where appropriate (Example: ‘total arsenic’);
- the concentration range covered by the validation (Example: ‘0-50 ppm’);
- a specification of the range of matrices of the test material covered by the validation (Example: ‘seafood’);
- a protocol, describing the equipment, reagents, procedure (including permissible variation in specified instructions, e.g., ‘heat at $100 \pm 5^\circ$ for 30 ± 5 minutes’), calibration and quality procedures, and any special safety precautions required;
- the intended application and its critical uncertainty requirements (Example: ‘The analysis of food for screening purposes. The standard uncertainty $u(c)$ of the result c should be less than $0.1 \times c$.’).

A2 Selectivity

Selectivity is the degree to which a method can quantify the analyte accurately in the presence of interferences. Ideally, selectivity should be evaluated for any important interferent likely to be present. It is particularly important to check interferences which are likely, on chemical principles, to respond to the test. For example, colorimetric tests for ammonia might reasonably be expected to respond to primary aliphatic amines. It may be impracticable to consider or test every potential interferent; where that is the case, it is recommended that the likely worst cases are checked. As a general principle, selectivity should be sufficiently good for any interferences to be ignored.

In many types of analysis, selectivity is essentially a qualitative assessment based on the significance or otherwise of suitable tests for interference. However, there are useful quantitative measures. In particular, one quantitative measure is the selectivity index b_{an}/b_{int} , where b_{an} is the sensitivity of the method (slope of the

calibration function) and b_{int} the slope of the response independently produced by a potential interferent, provides a quantitative measure of interference. b_{int} can be determined approximately by execution of the procedure on a matrix blank and the same blank spiked with the potential interferent at one appropriate concentration. If a matrix blank is unavailable, and a typical material used instead, b_{int} can be estimated from such a simple experiment only under the assumption that mutual matrix effects are absent. Note that b_{int} is more easily determined in the absence of the analyte because the effect might be confused with another type of interference when the sensitivity of the analyte is itself affected by the interferent (a matrix effect).

A3 Calibration and linearity

With the exception of gross errors in preparation of calibration materials, calibration errors are usually (but not always) a minor component of the total uncertainty budget, and can usually be safely subsumed into various categories estimated by “top-down” methods. For example random errors resulting from calibration are part of the run bias, which is assessed as a whole, while systematic errors from that source may appear as laboratory bias, likewise assessed as a whole. Never-the-less, there are some characteristics of calibration that are useful to know at the outset of method validation, because they affect the strategy for the optimal development of the procedure. In this class are such questions as whether the calibration function plausibly (a) is linear, (b) passes through the origin and (c) is unaffected by the matrix of the test material. The procedures described here relate to calibration studies in validation, which are necessarily more exacting than calibration undertaken during routine analysis. For example, once it is established at validation that a calibration function is linear and passes through the origin, a much simpler calibration strategy can be used for routine use (for example, a two point repeated design). Errors from this simpler calibration strategy will normally be subsumed into higher level errors for validation purposes.

A3.1 Linearity and intercept

Linearity can be tested informally by examination of a plot of residuals produced by linear regression of the responses on the concentrations in an appropriate calibration set. Any curved pattern suggests lack of fit due to a non-linear calibration function. A test of significance can be undertaken by comparing the lack-of-fit variance with that due to pure error. However, there are causes of lack of fit other than nonlinearity that can arise in certain types of analytical calibration, so the significance test must be used in conjunction with a residual plot. Despite its current widespread use as an indication of quality of fit, the correlation coefficient

is misleading and inappropriate as a test for linearity and should not be used.

Design is all-important in tests for lack of fit, because it is easy to confound nonlinearity with drift. Replicate measurements are needed to provide an estimate of pure error if there is no independent estimate. In the absence of specific guidance, the following should apply:

- there should be six or more calibrators;
- the calibrators should be evenly spaced over the concentration range of interest;
- the range should encompass 0-150% or 50-150% of the concentration likely to be encountered, depending on which of these is the more suitable;
- the calibrators should be run at least in duplicate, and preferably triplicate or more, in a random order.

After an exploratory fit with simple linear regression, the residuals should be examined for obvious patterns. Heteroscedasticity is quite common in analytical calibration and a pattern suggesting it means that the calibration data are best treated by weighted regression. Failure to use weighted regression in these circumstances could give rise to exaggerated errors at the low end of the calibration function.

The test for lack of fit can be carried out with either simple or weighted regression. A test for an intercept significantly different from zero can also be made on this data if there is no significant lack of fit.

A3.2 Test for general matrix effect

It simplifies calibration enormously if the calibrators can be prepared as a simple solution of the analyte. The effects of a possible general matrix mismatch must be assessed in validation if this strategy is adopted. A test for general matrix effect can be made by applying the method of analyte additions (also called “standard additions”) to a test solution derived from a typical test material. The test should be done in a way that provides the same final dilution as the normal procedure produces, and the range of additions should encompass the same range as the procedure-defined calibration validation. If the calibration is linear the slopes of the usual calibration function and the analyte additions plot can be compared for significant difference. A lack of significance means that there is no detectable general matrix effect. If the calibration is not linear a more complex method is needed for a significance test, but a visual comparison at equal concentrations will usually suffice. A lack of significance in this test will often mean that the matrix

variation effect [Section A13] will also be absent.

A3.3 Final calibration procedure

The calibration strategy as specified in the procedure may also need to be separately validated, although the errors involved will contribute to jointly estimated uncertainties. The important point here is that evaluation uncertainty estimated from the specific designs for linearity etc., will be smaller than those derived from the simpler calibration defined in the procedure protocol.

A4 Trueness

A4.1 Estimation of trueness

Trueness is the closeness of agreement between a test result and the accepted reference value of the property being measured. Trueness is stated quantitatively in terms of “bias”; with smaller bias indicating greater trueness. Bias is typically determined by comparing the response of the method to a reference material with the known value assigned to the material. Significance testing is recommended. Where the uncertainty in the reference value is not negligible, evaluation of the results should consider the reference material uncertainty as well as the statistical variability.

A4.2 Conditions for trueness experiments

Bias can arise at different levels of organisation in an analytical system, for example, run bias, laboratory bias and method bias. It is important to remember which of these is being handled by the various methods of addressing bias. In particular:

- The mean of a series of analyses of a reference material, carried out wholly within a single run, gives information about the sum of method, laboratory and run effect for that particular run. Since the run effect is assumed to be random from run to run, the result will vary from run to run more than would be expected from the observable dispersion of the results, and this needs to be taken into account in the evaluation of the results (for example, by testing the measured bias against the among-runs standard deviation investigated separately).
- The mean of repeated analyses of a reference material in several runs, estimates the combined effect of method and laboratory bias in the

particular laboratory (except where the value is assigned using the particular method).

A4.3 Reference values for trueness experiments

A4.3.1 Certified reference materials (CRMs)

CRMs are traceable to international standards with a known uncertainty and therefore can be used to address all aspects of bias (method, laboratory and within-laboratory) simultaneously, assuming that there is no matrix mismatch. CRMs should accordingly be used in validation of trueness where it is practicable to do so. It is important to ensure that the certified value uncertainties are sufficiently small to permit detection of a bias of important magnitude. Where they are not, the use of CRMs is still recommended, but additional checks should be carried out.

A typical trueness experiment generates a mean response on a reference material. In interpreting the result, the uncertainty associated with the certified value should be taken into account along with the uncertainty arising from statistical variation in the laboratory. The latter term may be based on the within-run, between-run, or an estimate of the between-laboratory standard deviation depending on the intent of the experiment. Statistical or materials. Where the certified value uncertainty is small, a Student's *t* test is normally carried out, using the appropriate precision term.

Where necessary and practicable, a number of suitable CRMs, with appropriate matrices and analyte concentrations, should be examined. Where this is done, and the uncertainties on the certified values are smaller than those on the analytical results, it would be reasonably safe to use simple regression to evaluate the results. In this way bias could be expressed as a function of concentration, and might appear as a non-zero intercept ("transitional" or constant bias) or as a non-unity slope ("rotational" or proportional bias). Due caution should be applied in interpreting the results where the range of matrices is large.

4.3.2 Reference materials

Where CRMs are not available, or as an addition to CRMs, use may be made of any material sufficiently well characterised for the purpose (a reference material¹⁰), bearing in mind always that while insignificant bias may not be proof of zero bias, significant bias on any material remains a cause for investigation. Examples of reference materials include: Materials characterised by a reference material producer, but whose values are not accompanied by an uncertainty statement or are otherwise qualified; materials characterised by a manufacturer of

the material; materials characterised in the laboratory for use as reference materials; materials subjected to a restricted round-robin exercise, or distributed in a proficiency test. While the traceability of these materials may be questionable, it would be far better to use them than to conduct no assessment for bias at all. The materials would be used in much the same way as CRMs, though with no stated uncertainty any significance test relies wholly on the observable precision of results.

A4.3.3 Use of a reference method

A reference method can in principle be used to test for bias in another method under validation. This is a useful option when checking an alternative to, or modification of, an established standard method already validated and in use in the laboratory. Both methods are used to analyse a number of typical test materials, preferably covering a useful range of concentration fairly evenly. Comparison of the results over the range by a suitable statistical method (for example, a paired *t*-test, with due checks for homogeneity of variance and normality) would demonstrate any bias between the methods.

A4.3.4 Use of spiking/recovery

In the absence of reference materials, or to support reference material studies, bias can be investigated by spiking and recovery. A typical test material is analysed by the method under validation both in its original state and after the addition (spiking) of a known mass of the analyte to the test portion. The difference between the two results as a proportion of the mass added is called the surrogate recovery or sometimes the marginal recovery. Recoveries significantly different from unity indicate that a bias is affecting the method. Strictly, recovery studies as described here only assess bias due to effects operating on the added analyte; the same effects do not necessarily apply to the same extent to the native analyte, and additional effects may apply to the native analyte. Spiking/recovery studies are accordingly very strongly subject to the observation that while good recovery is not a guarantee of trueness, poor recovery is certainly an indication of lack of trueness. Methods of handling spiking/recovery data have been covered in detail elsewhere.⁴

A5 Precision

Precision is the closeness of agreement between independent test results obtained under stipulated conditions. It is usually specified in terms of standard deviation or relative standard deviation. The distinction between precision and bias is

fundamental, but depends on the level at which the analytical system is viewed. Thus from the viewpoint of a single determination, any deviation affecting the calibration for the run would be seen as a bias. From the point of view of the analyst reviewing a year's work, the run bias will be different every day and act like a random variable with an associated precision. The stipulated conditions for the estimation of precision take account of this change in view point.

For single laboratory validation, two sets of conditions are relevant: (a) precision under repeatability conditions, describing variations observed during a single run as expectation 0 and standard deviation σ_r , and (b) precision under run-to-run conditions, describing variations in run bias δ_{run} as expectation 0, standard deviation σ_{run} . Usually both of these sources of error are operating on individual analytical results, which therefore have a combined precision $\sigma_{tot} = (\sigma_r^2/n + \sigma_{run}^2)^{1/2}$, where n is the number of repeat results averaged within a run for the reported result. The two precision estimates can be obtained most simply by analysing the selected test material in duplicate in a number of successive runs. The separate variance components can then be calculated by the application of one-way analysis of variance. Each duplicate analysis must be an independent execution of the procedure applied to a separate test portion. Alternatively the combined precision σ_{tot} can be estimated directly by the analysis of the test material once in successive runs, and estimating the standard deviation from the usual equation. (Note that observed standard deviations are generally given the symbol s , to distinguish them from standard deviations σ).

It is important that the precision values are representative of likely test conditions. First, the variation in conditions among the runs must represent what would normally happen in the laboratory under routine use of the method. For instance, variations in reagent batches, analysts and instruments should be representative. Second, the test material used should be typical, in terms of matrix and (ideally) the state of comminution, of the materials likely to encountered in routine application. So actual test materials or, to a lesser degree, matrix-matched reference materials would be suitable, but standard solutions of the analyte would not. Note also that CRMs and prepared reference materials are frequently homogenised to a greater extent than typical test materials, and precision obtained from their analysis may accordingly under-estimate the variation that will be observed for test materials.

Precision very often varies with analyte concentration. Typical assumptions are i) that there is no change in precision with analyte level, or ii) that the standard deviation is proportional to, or linearly dependent on, analyte level. In both cases,

the assumption needs to be checked if the analyte level is expected to vary substantially (that is, by more than about 30% from its central value). The most economical experiment is likely to be a simple assessment of precision at or near the extremes of the operating range, together with a suitable statistical test for difference in variance. The F-test is appropriate for normally distributed error.

Precision data may be obtained for a wide variety of different sets of conditions in addition to the minimum of repeatability and between-run conditions indicated here, and it may be appropriate to acquire additional information. For example, it may be useful to the assessment of results, or for improving the measurement, to have an indication of separate operator and run effects, between or within-day effects or the precision attainable using one or several instruments. A range of different designs and statistical analysis techniques is available, and careful experimental design is strongly recommended in all such studies.

A6 Recovery

Methods for estimating recovery are discussed in conjunction with methods of estimating trueness (above).

A7 Range

The validated range is the interval of analyte concentration within which the method can be regarded as validated. It is important to realise that this range is not necessarily identical to the useful range of the calibration. While the calibration may cover a wide concentration range, the remainder of the validation (and usually much more important part in terms of uncertainty) will cover a more restricted range. In practice, most methods will be validated at only one or two levels of concentration. The validated range may be taken as a reasonable extrapolation from these points on the concentration scale.

When the use of the method focuses on a concentration of interest well above the detection limit, validation near that one critical level would be appropriate. It is impossible to define a general safe extrapolation of this result to other concentrations of the analyte, because much depends on the individual analytical system. Therefore the validation study report should state the range around the critical value in which the person carrying out the validation, using professional judgement, regards the estimated uncertainty to hold true.

When the concentration range of interest approaches zero, or the detection limit, it is incorrect to assume either constant absolute uncertainty or constant relative

uncertainty. A useful approximation in this common circumstance is to assume a linear functional relationship, with a positive intercept, between uncertainty u and concentration c , that is of the form

$$u(c) = u_0 + \theta c$$

where θ is the relative uncertainty estimated at some concentration well above the detection limit. u_0 is the standard uncertainty estimated for zero concentration and in some circumstances could be estimated as $c_L / 3$. In these circumstances it would be reasonable to regard the validated range as extending from zero to a small integer multiple of the upper validation point. Again this would depend on professional judgement.

A8 Detection Limit

In broad terms the detection limit (limit of detection) is the smallest amount or concentration of analyte in the test sample that can be reliably distinguished from zero.^{22,23} For analytical systems where the validation range does not include or approach it, the detection limit does not need to be part of a validation.

Despite the apparent simplicity of the idea, the whole subject of the detection limit is beset with problems outlined below:

- There are several possible conceptual approaches to the subject, each providing a somewhat different definition of the limit. Attempts to clarify the issue seem ever more confusing.
- Although each of these approaches depends on an estimate of precision at or near zero concentration, it is not clear whether this should be taken as implying repeatability conditions or some other condition for the estimation.
- Unless an inordinate amount of data is collected, estimates of detection limit will be subject to quite large random variation.
- Estimates of detection limit are often biased on the low side because of operational factors.
- Statistical inferences relating to the detection limit depend on the assumption of normality, which is at least questionable at low concentrations.

For most practical purposes in method validation, it seems better to opt for a

simple definition, leading to a quickly implemented estimation which is used only as a rough guide to the utility of the method. However, it must be recognised that the detection limit as estimated in method development, may not be identical in concept or numerical value to one used to characterise a complete analytical method. For instance the “instrumental detection limit”, as quoted in the literature or in instrument brochures and then adjusted for dilution, is often far smaller than a “practical” detection limit and inappropriate for method validation.

It is accordingly recommended that for method validation, the precision estimate used ($\hat{\sigma}_0$) should be based on at least 6 independent complete determinations of analyte concentration in a typical matrix blank or low-level material, with no censoring of zero or negative results, and the approximate detection limit calculated as $3\hat{\sigma}_0$. Note that with the recommended minimum number of degrees of freedom, this value is quite uncertain, and may easily be in error by a factor of two. Where more rigorous estimates are required (for example to support decisions based on detection or otherwise of a material), reference should be made to appropriate guidance (see, for example, references 22-23).

A9 Limit of determination or limit of quantification

It is sometimes useful to state a concentration below which the analytical method cannot operate with an acceptable precision. Sometimes that precision is arbitrarily defined as 10% RSD, sometimes the limit is equally arbitrarily taken as a fixed multiple (typically 2) of the detection limit. While it is to a degree reassuring to operate above such a limit, we must recognise that it is a quite artificial dichotomy of the concentration scale: measurements below such a limit are not devoid of information content and may well be fit for purpose. Hence the use of this type of limit in validation is not recommended here. It is preferable to try to express the uncertainty of measurement as a function of concentration and compare that function with a criterion of fitness for purpose agreed between the laboratory and the client or end-user of the data.

A10 Sensitivity

The sensitivity of a method is the gradient of the calibration function. As this is usually arbitrary, depending on instrumental settings, it is not useful in validation. (It may be useful in quality assurance procedures, however, to test whether an instrument is performing to a consistent and satisfactory standard.)

A11 Ruggedness

The ruggedness of an analytical method is the resistance to change in the results produced by an analytical method when minor deviations are made from the experimental conditions described in the procedure. The limits for experimental parameters should be prescribed in the method protocol (although this has not always been done in the past), and such permissible deviations, separately or in any combination, should produce no meaningful change in the results produced. (A “meaningful change” here would imply that the method could not operate within the agreed limits of uncertainty defining fitness for purpose.) The aspects of the method which are likely to affect results should be identified, and their influence on method performance evaluated by using ruggedness tests.

The ruggedness of a method is tested by deliberately introducing small changes to the procedure and examining the effect on the results. A number of aspects of the method may need to be considered, but because most of these will have a negligible effect it will normally be possible to vary several at once. An economical experiment based on fractional factorial designs has been described by Youden¹³. For instance, it is possible to formulate an approach utilising 8 combinations of 7 variable factors, that is to look at the effects of seven parameters with just eight analytical results. Univariate approaches are also feasible, where only one variable at a time is changed.

Examples of the factors that a ruggedness test could address are: changes in the instrument, operator, or brand of reagent; concentration of a reagent; pH of a solution; temperature of a reaction; time allowed for completion of a process etc.

A12 Fitness for Purpose

Fitness for purpose is the extent to which the performance of a method matches the criteria, agreed between the analyst and the end-user of the data, that describe the end-user’s needs. For instance the errors in data should not be of a magnitude that would give rise to incorrect decisions more often than a defined small probability, but they should not be so small that the end-user is involved in unnecessary expenditure. Fitness for purpose criteria could be based on some of the characteristics described in this Annex, but ultimately will be expressed in terms of acceptable total uncertainty.

A13 Matrix variation

Matrix variation is, in many sectors, one of the most important but least acknowledged sources of error in analytical measurements. When we define the

analytical system to be validated by specifying, amongst other things, the matrix of the test material, there may be scope for considerable variation within the defined class. To cite an extreme example, a sample of the class “soil” could be composed of clay, sand, chalk, laterite (mainly Fe₂O₃ and Al₂O₃), peat, etc., or of mixtures of these. It is easy to imagine that each of these types would contribute a unique matrix effect on an analytical method such as atomic absorption spectrometry. If we have no information about the type of soils we are analysing, there will be an extra uncertainty in the results because of this variable matrix effect.

Matrix variation uncertainties need to be quantified separately, because they are not taken into account elsewhere in the process of validation. The information is acquired by collecting a representative set of the matrices likely to be encountered within the defined class, all with analyte concentrations in the appropriate range. The material are analysed according to the protocol, and the bias in the results estimated. Unless the test materials are CRMs, the bias estimate will usually have to be undertaken by means of spiking and recovery estimation. The uncertainty is estimated by the standard deviation of the biases. (Note: This estimate will also contain a variance contribution from the repeat analysis. This will have a magnitude $2\sigma_r^2$ if spiking has been used. If a strict uncertainty budget is required, this term should be deducted from the matrix variation variance to avoid double accounting.)

A14 Measurement Uncertainty

The formal approach to measurement uncertainty estimation calculates a measurement uncertainty estimate from an equation, or mathematical model. The procedures described as method validation are designed to ensure that the equation used to estimate the result, with due allowance for random errors of all kinds, is a valid expression embodying all recognised and significant effects upon the result. It follows that, with one caveat elaborated further below, the equation or ‘model’ subjected to validation may be used directly to estimate measurement uncertainty. This is done by following established principles, based on the ‘law of propagation of uncertainty’ which, for independent input effects is

$$u(y(x_1, x_2, \dots)) = \sqrt{\sum_{i=1, n} c_i^2 u(x_i)^2}$$

where $y(x_1, x_2, \dots, x_n)$ is a function of several independent variables x_1, x_2, \dots , and c_i is a sensitivity coefficient evaluated as $c_i = \partial y / \partial x_i$, the partial differential of y with respect to x_i . $u(x_i)$ and $u(y)$ are *standard uncertainties*, that is, measurement

uncertainties expressed in the form of standard deviations. Since $u(y(x_1, x_2, \dots))$ is a function of several separate uncertainty estimates, it is referred to as a *combined standard uncertainty*.

To estimate measurement uncertainty from the equation $y=f(x_1, x_2, \dots)$ used to calculate the result, therefore, it is necessary first, to establish the uncertainties $u(x_i)$ in each of the terms x_1, x_2 etc. and second, to combine these with the additional terms required to represent random effects as found in validation, and finally to take into account any additional effects. In the discussion of precision above, the implied statistical model is

$$y=f(x_1, x_2, \dots) + \delta_{\text{run}} + e$$

where e is the random error for a particular result. Since δ_{run} and e are known, from the precision experiments, to have standard deviations σ_{run} and σ_r respectively, these latter terms (or, strictly, their estimates s_{run} and s_r) are the uncertainties associated with these additional terms. Where the individual within-run results are averaged, the combined uncertainty associated with these two terms is (as given previously) $s_{\text{tot}} = (s_r^2/n + s_{\text{run}}^2)^{1/2}$. Note that where the precision terms are shown to vary with analyte level, the uncertainty estimate for a given result must employ the precision term appropriate to that level. The basis for the uncertainty estimate accordingly follows directly from the statistical model assumed and tested in validation. To this estimate must be added any further terms as necessary to account for (in particular) inhomogeneity and matrix effect (see section A13). Finally, the calculated standard uncertainty is multiplied by a ‘coverage factor’, k , to provide an expanded uncertainty, that is, “an interval expected to encompass a large fraction of the distribution of values that may be attributed to the measurand”⁸. Where the statistical model is well established, the distribution known to be normal, and the number of degrees of freedom associated with the estimate is high, k is generally chosen to be equal to 2. The expanded uncertainty then corresponds approximately to a 95% confidence interval.

There is one important caveat to be added here. In testing the assumed statistical model, imperfect tests are perforce used. It has already been noted that these tests can not prove that any effect is identically zero; they can only show that an effect is too small to detect within the uncertainty associated with the particular test for significance. A particularly important example is the test for significant laboratory bias. Clearly, if this is the only test performed to confirm trueness, there must be some residual uncertainty as to whether the method is indeed unbiased or not. It follows that where such uncertainties are significant with respect to the uncertainty calculated so far, additional allowance should be made.

In the case of an uncertain reference value, the simplest allowance is the stated uncertainty for the material, combined with the statistical uncertainty in the test applied. A full discussion is beyond the scope of this text; reference 9 provides further detail. It is, however, important to note that while the uncertainty estimated directly from the assumed statistical model is the *minimum* uncertainty that can be associated with an analytical result, it will almost certainly be an underestimate; similarly, an expanded uncertainty based on the same considerations and using $k=2$ will not provide sufficient confidence.

The ISO Guide⁸ recommends that for increased confidence, rather than arbitrarily adding terms, the value of k should be increased as required. Practical experience suggests that for uncertainty estimates based on a validated statistical model, but with no evidence beyond the validation studies to provide additional confidence in the model, k should not be less than 3. Where there is strong reason to doubt that the validation study is comprehensive, k should be increased further as required.

**ANNEX B. Additional considerations for UNCERTAINTY ESTIMATION
IN VALIDATION STUDIES**

B1 Sensitivity analysis

The basic expression used in uncertainty estimation

$$u(y(x_1, x_2, \dots)) = \sqrt{\sum_{i=1, n} c_i^2 u(x_i)^2}$$

requires the ‘sensitivity coefficients’ c_i . It is common in uncertainty estimation to find that while a given influence factor x_i has a known uncertainty $u(x_i)$, the coefficient c_i is insufficiently characterised or not readily obtainable from the equation for the result. This is particularly common where an effect is not included in the measurement equation because it is not normally significant, or because the relationship is not sufficiently understood to justify a correction. For example, the effect of solution temperature T_{sol} on a room temperature extraction procedure is rarely established in detail.

Where it is desired to assess the uncertainty in a result associated with such an effect, it is possible to determine the coefficient experimentally. This is done most simply by changing x_i and observing the effect on the result, in a manner very similar to basic ruggedness tests. In most cases, it is sufficient in the first instance to choose at most two values of x_i other than the nominal value, and calculate an approximate gradient from the observed results. The gradient then gives an approximate value for c_i . The term $c_i u(x_i)$ can then be determined. (Note that this is one practical method for demonstrating the significance or otherwise of a possible effect on the results).

In such an experiment, it is important that the change in result observed be sufficient for a reliable calculation of c_i . This is difficult to predict in advance. However, given a permitted range for the influence quantity x_i , or an expanded uncertainty for the quantity, that is expected to result in insignificant change, it is clearly important to assess c_i from a larger range. It is accordingly recommended that for an influence quantity with an expected range of $\pm a$, (where $\pm a$ might be, for example, the permitted range, expanded uncertainty interval or 95% confidence interval) the sensitivity experiment employ, where possible, a change of at least $4a$ to ensure reliable results.

B2 Judgement

It is not uncommon to find that while an effect is recognised and may be significant, it is not always possible to obtain a reliable estimate of uncertainty. In such circumstances, the ISO Guide makes it quite clear that a professionally considered estimate of the uncertainty is to be preferred to neglect of the uncertainty. Thus, where no estimate of uncertainty is available for a potentially important effect, the analyst should make their own best judgement of the likely uncertainty and apply that in estimating the combined uncertainty. Reference 8 gives further guidance on the use of judgement in uncertainty estimation.

Recommendations on measurement uncertainty
(Resolution oeno 9/2005)

INTRODUCTION

It is important that analysts are aware of the uncertainty associated with each analytical result and estimates of uncertainty. The measurement uncertainty may be derived by a number of procedures. Food analysis laboratories are required to be in control, use collaboratively tested methods when available, and verify their application before taking them into routine use. Such laboratories therefore have available to them a range of analytical data which can be used to estimate their measurement uncertainty.

Terminology

The accepted definition for Measurement Uncertainty¹ is:
“Parameter, associated with the result of a measurement, that characterises the dispersion of the values that could reasonably be attributed to the measurand.

NOTES:

1. The parameter may be, for example, a standard deviation (or a given multiple of it), or the half-width of an interval having a stated level of confidence.
2. Uncertainty of measurement comprises, in general, many components. Some of these components may be evaluated from the statistical distribution of results of a series of measurements and can be characterised by experimental standard deviations. The other components, which can also be characterised by standard deviations, are evaluated from assumed probability distributions based on experience or other information.
3. It is understood that the result of a measurement is the best estimate of the value of a measurand, and that all components of uncertainty, including those arising from systematic effects. Such as components associated with corrections and reference standards, contribute to the dispersion.”

[It is recognised that the term “measurement uncertainty” is the most widely used term by International Organisations and Accreditation Agencies. However The Codex ALIMENTARIUS Committee on Methods of Analysis and Sampling has

commented on a number of occasions that the term “Measurement Uncertainty” has some negative associations in legal context and so has noted that an alternative, equivalent, term, “measurement reliability”, may be used.]

Recommendations

The following recommendations are made to governments:

1. For OIV purposes the term “measurement uncertainty” or “measurement reliability” shall be used.
2. The measurement uncertainty or “measurement reliability” associated with all analytical results is to be estimated and must, on request be made available to the user (customer) of the results.
3. The measurement uncertainty or “measurement reliability” of an analytical result may be estimated in a number of procedures notably those described by ISO¹ and EURACHEM². These documents recommend procedures based on a component-by-component approach, method validation data, internal quality control data and proficiency test data. The need to undertake an estimation of the measurement uncertainty or “Measurement reliability” using the ISO component-by-component approach is not necessary if the other forms of data are available and used to estimate the uncertainty or reliability. In many cases the overall uncertainty may be determined by an inter-laboratory (collaborative) study by a number of laboratories and a number of matrices by the IUPAC/ISO/AOAC INTERNATIONAL³ or by the ISO 5725 Protocols⁴.

REFERENCES

1. “Guide to the Expression of Uncertainty in Measurement”, ISO, Geneva, 1993.
2. EURACHEM/CITAC Guide Quantifying Uncertainty In Analytical Measurement (Second Edition), EURACHEM Secretariat, HAM, Berlin, 2000. This is available as a free download from <http://www.vtt.fi/ket/eurachem>.
3. “Protocol for the Design, Conduct and Interpretation of Method Performance Studies”, ed. W. Horwitz, Pure Appl. Chem., 1995, 67, 331-343.
4. “Precision of Test Methods”, Geneva, 1994, ISO 5725, Previous editions were published in 1981 and 1986.

Recommendations related to the recovery correction
(Resolution OIV-Oeno 392/2009)

Recovery

“The OIV recommends the following practice with regards to reporting recovery of analytical results.

- Analytical results are to be expressed on a recovery corrected basis where appropriate and relevant, and when corrected it has to be stated.
- If a result has been corrected for recovery, the method by which the recovery was taken into account should be stated. The recovery rate is to be quoted wherever possible.
- When laying down provisions for standards, it will be necessary to state whether the result obtained by a method used for analysis within conformity checks shall be expressed on a recovery-corrected basis or not.”

Annex F

Specific methods for the analysis of grape sugar¹ (rectified concentrated musts)

¹ Grape sugar are defined in Part I-6.2 and in Part II-2.1.12 of the International Code of Oenological Practices of the OIV.

Specifications of grape sugar are described in file COEI-1-SUCRAI of International Oenological Codex of the OIV.

Method OIV-MA-F1-01

Type IV method

Conductivity

(Oeno 419A-2011)

1. Principle

The electrical conductivity of a column of liquid defined by two parallel platinum electrodes at its ends is measured by incorporating it in one arm of a Wheatstone bridge.

The conductivity varies with temperature and it is therefore expressed at 20°C.

2. Reagents

Use only reagent grade chemicals

2.1 Purified water for laboratories, with specific conductivity below 2 $\mu\text{S cm}^{-1}$ at 20°C, for example EN ISO 3696 type II water.

2.2 Reference solution of potassium chloride.

Dissolve 0.581 g of potassium chloride, KCl previously dried to constant mass at a temperature of 105°C, in demineralised water (2.1).

Make up to one litre with demineralised water (2.1). This solution has a conductivity of 1 000 $\mu\text{S cm}^{-1}$ at 20°C. It should not be kept for more than three months.

A commercial preparation can be used.

3. Apparatus

3.1 Conductivity meter enabling measurements of conductivity to be made over a range from 1 to 1 000 microsiemens per cm ($\mu\text{S cm}^{-1}$).

3.2 Water bath for bringing the temperature of samples to be analysed to approximately 20°C ($20 \pm 2^\circ\text{C}$).

4. Procedure**4.1 Preparation of the sample to be analysed**

Use a solution with a total sugar concentration of 25 ± 0.5 % (m/m) (25° Brix): weigh a mass equal to $2500/P$ and make up to 100 g with water (2.1),

P = percentage (m/m) of total sugars in the rectified concentrated must.

4.2 Determination of conductivity

Bring the sample to be analysed to 20°C by immersion in a water bath. Maintain the temperature to within ± 0.1 °C.

Rinse the conductivity cell twice with the solution to be examined.

Measure the conductivity and express the result in $\mu\text{S cm}^{-1}$.

5. Expression of the Results

The result is expressed in microsiemens per cm (μScm^{-1}) at 20°C to the nearest whole number for the 25% (m/m) (25° Brix) solution of rectified concentrated must.

5.1 Calculations

If the apparatus does not have temperature compensation, correct the measured conductivity using Table I. If the temperature is below 20°C, add the correction; if the temperature is above 20°C, subtract the correction.

6. Characteristics of the method

Repeatability (r)

$$r = 3 \mu\text{S/cm}$$

Reproducibility (R)

$$R = 16 \mu\text{S/cm}$$

Conductivity

TABLE I

Corrections to be made to the conductivity for temperatures different from
20°C ($\mu\text{S cm}^{-1}$)

Conductivity	Temperature (°C)									
	20.2 19.8	20.4 19.6	20.6 19.4	20.8 19.2	21.0 19.0	21.2 18.8	21.4 18.6	21.6 18.4	21.8 18.2	22,0 ⁽¹⁾ 18.0 ⁽²⁾
0	0	0	0	0	0	0	0	0	0	0
50	0	0	1	1	1	1	1	2	2	2
100	0	1	1	2	2	3	3	3	4	4
150	1	1	2	3	3	4	5	5	6	7
200	1	2	3	3	4	5	6	7	8	9
250	1	2	3	4	6	7	8	9	10	11
300	1	3	4	5	7	8	9	11	12	13
350	1	3	5	6	8	9	11	12	14	15
400	2	3	5	7	9	11	12	14	16	18
450	2	3	6	8	10	12	14	16	18	20
500	2	4	7	9	11	13	15	18	20	22
550	2	5	7	10	12	14	17	19	22	24
600	3	5	8	11	13	16	18	21	24	26

⁽¹⁾Subtract the correction.

⁽²⁾Add the correction.

Method OIV-MA-F1-02

Type IV method

**Hydroxymethylfurfural (HMF) by High-Performance Liquid
Chromatography**
(Oeno 419A-2011)

1. Principle of the Method

High-performance liquid chromatography (HPLC)

Separation through a column by reversed-phase chromatography and determination at 280 nm.

2. Reagents

2.1 Purified water for laboratory use and of quality standard EN ISO 3696

2.2 Methanol, CH₃OH, distilled or HPLC quality. – CAS Number 67-59-1

2.3 Acetic acid, CH₃COOH, ($\rho_{20} = 1.05$ g/ml). – CAS Number 64-19-7

2.4 Mobile phase: water (2.1) -methanol (2.2)-acetic acid (2.3) previously filtered through a membrane filter (0.45 μ m), (40:9:1 v/v).

This mobile phase must be prepared daily and degassed before use.

2.5 Reference solution of hydroxymethylfurfural, 25 mg/l (m/v).

Into a 100 ml volumetric flask, place 25 mg of hydroxymethylfurfural, C₆H₃O₆, accurately weighed, and make up to the mark with methanol (2.2). Dilute this solution 1/10 with methanol (2.2) and filter through a membrane filter (0.45 μ m).

If kept in a hermetically sealed brown glass bottle in a refrigerator, this solution will keep for two to three months.

(The concentration of the reference solution is given for guidance)

3. Equipment

3.1 Apparatus

3.1.1 High-performance liquid chromatograph equipped with:

- a loop injector, 5 or 10 μ l, (as an example),
 - spectrophotometric detector for making measurements at 280 nm,
 - column of octadecyl-bonded silica (*e.g.*: *Bondapak C18* — *Corasil*, *Waters Ass.*),
 - a recorder and, if required, an integrator,
- Flow rate of mobile phase: 1.5 ml/minute (as an example).

3.1.2 Membrane filtration apparatus, pore diameter 0.45 µm.

4. Procedure

4.1 Preparation of sample

Use the solution obtained by diluting the rectified concentrated must to 40% (m/v) (introduce 200 g of accurately weighed rectified concentrated must into a 500 ml volumetric flask. Make up to the mark with water and homogenise) and filter it through a membrane filter (0.45 µm).

4.2 Chromatographic determination

Inject 5 (or 10) µl of the sample prepared as described in paragraph 4.1. and 5 (or 10) µl of the reference hydroxymethylfurfural solution (2.5) into the chromatograph. Record the chromatogram.

The retention time of hydroxymethylfurfural is approximately six to seven minutes.

The volume injected and the sequence are given for guidance. The chromatographic determination can also be done with a calibration curve

5. Expression of results

The hydroxymethylfurfural concentration in rectified concentrated musts is expressed in milligrams per kilogram of total sugars.

5.1 Method of calculation

Let the hydroxymethylfurfural concentration in the 40% (m/v) solution of the rectified concentrated must be *C* mg/l.

The hydroxymethylfurfural concentration in milligrams per kilogram of total sugars is given by:

$$250 \times C/P$$

P = percentage (m/m) concentration of total sugars in the rectified concentrated must.

6. Characteristics of the method

Repeatability (*r*)

$$r = 0.5 \text{ mg/kg total sugars}$$

Reproducibility (*R*)

$$R = 3.0 \text{ mg/kg total sugars}$$

OIV-MA-F1-03

Type IV method

**Determination of the acquired alcoholic strength by volume
(ASV) of concentrated musts (CM) and grape sugar (or
rectified concentrated musts, RCM)**
(Oeno 419A-2011)

1. Introduction

Concentrated musts (CM) and grape sugar (RCM) are viscous products with low alcohol contents; to determine their acquired ASV, a method must be used, the characteristics of which (linearity, repeatability, reproducibility, specificity, and detection and quantification limits) must be such that it is possible to measure alcohol contents of less than 1% vol.

2. Field of application

The method applies to concentrated musts and grape sugar.

3. Principle

A known mass of concentrated must (CM) or grape sugar is made alkaline by a suspension of calcium hydroxide and then distilled. The alcoholic strength by volume of the distillate is determined by electronic densitometry or by densitometry using a hydrostatic balance.

4. Reagents

- Suspension of 2M calcium hydroxide of analytical quality obtained by carefully pouring one litre of hot water (60°C to 70°C) on to about 120 g of unslaked lime (CaO).
- Antifoam solution obtained by dilution of 2 ml of concentrated silicone antifoam in 100 ml of water.
- Purified water for laboratory use and of quality EN ISO 3696.

5. Equipment

- Standard laboratory equipment including volumetric flasks
- Analytic balance capable of weighing to within 0.1 g.
- Any type of distillation or steam distillation apparatus may be used provided that it satisfies the following test:
Distil an ethanol-water mixture with an alcoholic strength of 10% vol. five times in succession. The distillate should have an alcoholic strength of at least 9.9% vol. after the fifth distillation; i.e. the loss of alcohol during each distillation should not be more than 0.02% vol.
- Electronic density meter or hydrostatic balance.

6. Procedure

- Homogenise the test sample by inverting the flask several times.
- In a 500 ml volumetric flask, weigh about 200 g of concentrated must or rectified concentrated must (to within 0.1 g). Note the weight (TS) of this test sample. Fill up to the mark with deionised water. This solution is about 40% m/v in must.

Obtaining the distillate

- Transfer 250 ml of the 40% solution to the distillation flask, add to the flask about 10 ml of calcium hydroxide in suspension, about 5 ml of antifoam solution and, where applicable, a boiling regulator (e.g. pieces of porcelain).
- Gently bring to the boil.
- Recover the distillate in a 100 ml volumetric flask (about 90 ml).
- Leave the distillate to return to ambient temperature, then fill up to the mark with deionised water.

Measurement of ASV

This is performed by electronic densitometry or by hydrostatic balance.

7. Calculation

$$\text{Acquired alcoholic strength by volume} = \frac{\text{ASV measured} \times 200 \times \text{MV}}{\text{TS}}$$

ASV measured = alcohol content given by the density meter, as % vol.

TS = test sample of concentrated must or grape sugar, in weight.

MV = density of concentrated must or rectified concentrated must, in g/ml

The results are expressed to 2 decimal places and rounded to within 0.05 %vol.

8. Characteristics of the method

8.1 Linearity of response

The linearity of the density meter for low ASV values is one of the critical parameters of this method. A standard range of 10 aqueous-alcoholic solutions of ASV ranging between 0 and 5%vol. was prepared. Each solution was analysed 3 times.

The response of the density meter is perfectly linear within this range as shown by the calibration line in Figure 1.

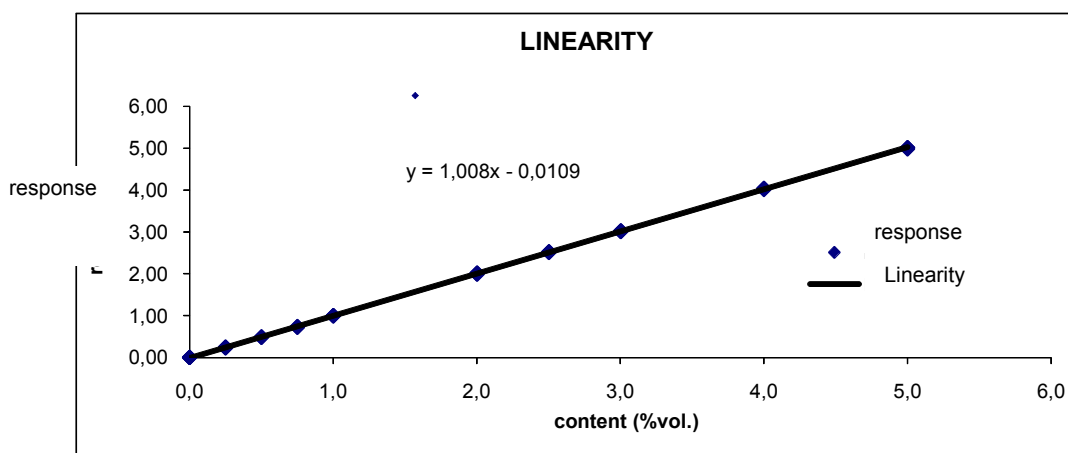

Figure 1: Linearity of determination of the ASV by electronic densitometry between 0 and 5%vol.

8.2 Specificity of the method

The second critical point of this method is the distillation of viscous musts containing small quantities of alcohol. In order to verify the specificity, known quantities of ethanol (from 0.25% vol to 5% vol) were added to CMs and grape sugar. The supplemented test specimens were distilled in the conditions defined earlier, then the distillates were analysed by electronic densitometry or by **hydrostatic balance**.

The results are shown in Table 1. The recovery rate is satisfactory, ranging between 88% and 99%. As shown by the line in Figure 2, the method is specific (slope in the vicinity of 1, intercept point in the vicinity of 0).

COMPENDIUM OF INTERNATIONAL ANALYSIS OF METHODS - OIV
Alcoholic strength by volume (ASV)

Table 1: Recovery rate for determination of the acquired ASV of CMs and Grape Sugar

Test specimen	Initial content (%vol.)	Added content (%vol.)	Recovered content (%vol.)	Recovery rate (%)
CM 1	0.00	0.25	0.22	88
CM 1	0.00	1.00	0.98	98
Grape Sugar (RCM) 1	0.00	1.00	0.94	94
Grape Sugar (RCM) 1	0.00	2.00	1.97	99
CM 2	0.00	0.50	0.44	88
Grape Sugar (RCM)2	0.00	5.00	4.94	99

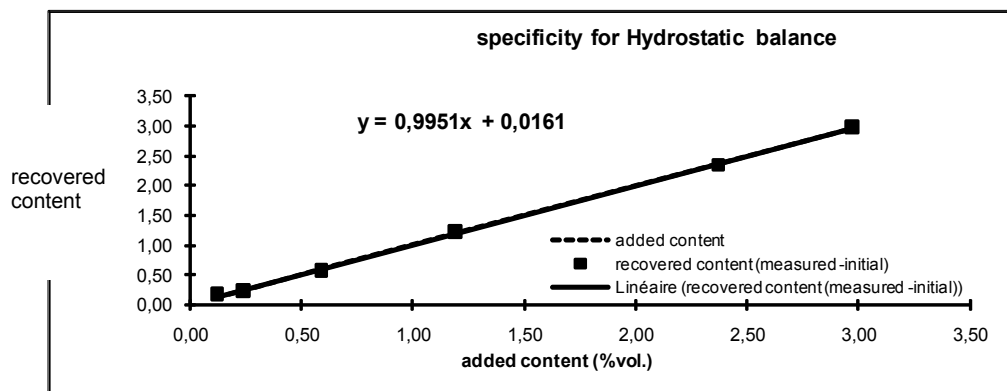
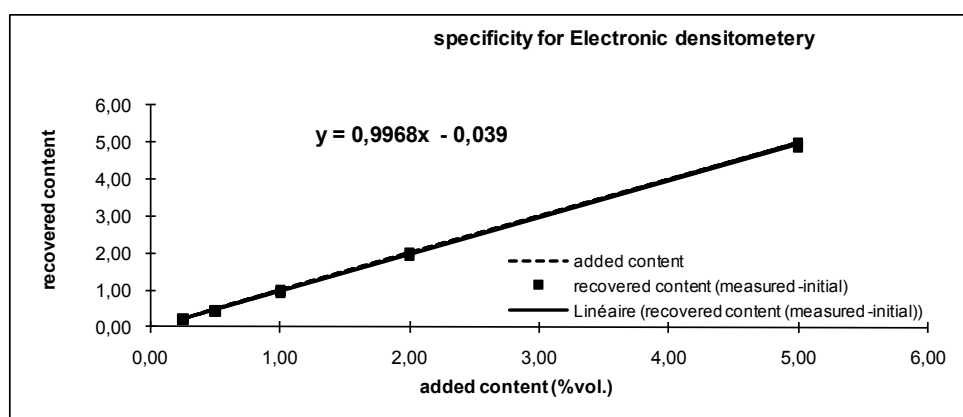

Figure 2: Specificity of determination of the acquired ASV of CMs and Grape Sugar

8.3 Repeatability

The repeatability of the method was determined using 20 test specimens of CM or grape sugar supplemented with alcohol or not. Each CM or RCM test specimen was analysed 3 times, in order to ensure identical conditions. The repeatability limits obtained are as follows:

Table 2: Repeatability of determination of the acquired ASV of CMs and Grape Sugar

Repeatability for electronic densitometry	Calculated value
Standard deviation	0.009
CV or RSD as %	0.9%
r limit	0.024 %vol.
r limit as %	3%
Repeatability for Hydrostatic balance	Calculated value
Standard deviation	0.013
CV or RSD as %	1.7%
r limit	0.038 %vol.
r limit as %	5,3%

8.4 Reproducibility

The reproducibility of the results is determined by analysing the same must twice, at different dates during a given period of time. The results are given in Table 3.

Table 3 - Reproducibility of determination of the acquired ASV of CMs and grape sugar

Reproducibility for electronic densitometry	Calculated value
Standard deviation	0.043
CV or RSD as %	3%
R limit	0.12%vol.
R limit as %	9%
Reproducibility for Hydrostatic balance	Calculated value
Standard deviation	0.026
CV or RSD as %	3.4%
R limit	0.076%vol.
R limit as %	10.6%

8.5 Detection and quantification limits

The limits of detection (LD) and quantification (LQ) estimated based on the linearity study are as follows:

$$\mathbf{LD = 0.01\%vol. \quad LQ = 0.05\%vol.}$$

The quantification limit was verified by analysis of musts having an ASV at a concentration level of 0.05%vol.

8.6 Uncertainty

Uncertainty, evaluated based on the reproducibility standard deviation, is 0.10%vol.

Method OIV-MA-F1-03

Type IV method

Sucrose by High-Performance Liquid Chromatography

(Oeno 419A-2011)

1. Principle

For testing and determination by high-performance liquid chromatography: the sucrose is separated in a column of alkylamine-bonded silica and detected by refractometry. The result is quantified by reference to an external standard analysed under the same conditions.

Note: Authentication of a must or of a wine may be checked by the method using NMR of deuterium described for detecting the enrichment of musts, rectified concentrated musts and wines.

The chromatographic conditions are given for guidance.

2. Reagents

2.1 Purified water for laboratory use and of quality EN ISO 3696..

2.2 HPLC quality acetonitrile (CH₃ CN) – CAS Number 75-05-8

2.3 Sucrose – CAS Number 57-50-1

2.4 Mobile phase: acetonitrile-water (80:20 v/v)., previously subjected to membrane filtration (0.45 µm); the composition of the mobile phase is given as an example.

This mobile phase must be degassed before being used.

2.5 Standard solution: 1.2 g/l aqueous sucrose solution. Filter using a 0.45 µm membrane filter. (The concentration of the standard solution is given as an example.)

3. Equipment

3.1 High-performance liquid chromatograph equipped with:

- 1) 10 µl loop injector (as an example)
- 2) a detector: a differential refractometer or an interferometer refractometer
- 3) an alkylamine-bonded silica column, length 25 cm, internal diameter 4 mm (as an example)
- 4) a guard column filled with the same phase (as an example)
- 5) an arrangement for insulating the guard column and analytical columns or for maintaining their temperature (30 ° C),
- 6) a recorder and, if required, an integrator,

7) mobile phase flow rate: 1 ml/min (as an example).

3.2 Equipment for membrane filtration (0.45 µm).

4. Procedure

4.1 Preparation of sample:

Use the solution obtained by diluting the rectified concentrated must to 40 % (m/v) as described in Annex H 'Total acidity', section 5.1., and filtering it using a 0.45 µm membrane filter.

4.2 Chromatographic determination

Inject in turn into the chromatograph 10 µl of the standard solution and 10 µl of the sample prepared as described in 4.1.

Repeat these injections in the same order.

Record the chromatogram.

The retention time of the sucrose is approximately 10 minutes.

The sample volume and sequence are given for guidance. The chromatographic determination can also be done with a calibration curve

5. Calculations

For the calculation, use the average of two results for the standard solution and the sample.

Let C be the sucrose concentration in g/l of the 40 % (m/v) solution of rectified concentrated must.

The sucrose concentration in g/kg of the rectified concentrated must is then:

$$2.5 \times C$$

6. Expression of results

The sucrose concentration is expressed in grams per kilogram, to one decimal place.

7. Characteristics of the method

Repeatability (r)

$$r = 1.1 \text{ g/kg must}$$

COMPENDIUM OF INTERNATIONAL ANALYSIS OF METHODS - OIV
Total acidity

Method OIV-MA-F1-05

Type IV method

TOTAL ACIDITY
(Oeno 419A-2011)

1. Definition

The total acidity of the rectified concentrated must is the sum of its titrable acidities when it is titrated to pH 7 against a standard alkaline solution. Carbon dioxide is not included in the total acidity.

2. Principle of the method

2.1 Potentiometric titration or titration with bromothymol blue as an indicator and comparison with an end-point colour standard.

3. Reagents

3.1 Buffer solutions

3.1.1 pH 7.0:

monopotassium phosphate, (KH₂PO₄) : 107.3 g
1 M sodium hydroxide (NaOH) solution: 500 ml
water to: 1 000 ml

3.1.2 pH 4.0

Solution of potassium hydrogen phthalate, 0.05 M, containing 10.211 g of potassium hydrogen phthalate (C₈H₅KO₄) per litre at 20 °C.

Note: commercial reference buffer solutions traceable to the SI may be used.

For example: pH 1.679 ± 0.01 at 25°C

pH 4.005 ± 0.01 at 25°C

pH 7.000 ± 0.01 at 25°C

3.2. 0,1 M sodium hydroxide (NaOH) solution.

3.3. 4 g/l bromothymol blue indicator solution:

Bromothymol blue (C₂₇H₂₈Br₂O₅S): 4 g
Neutral ethanol 96 % vol: 200 ml

Dissolve and add:

Water free of CO₂: 200 ml

COMPENDIUM OF INTERNATIONAL ANALYSIS OF METHODS - OIV
Total acidity

1 M sodium hydroxide solution sufficient to produce blue-green colour
(pH 7) approximately 7.5 ml
Water to: 1000 ml

4. Apparatus

4.1 Potentiometer with scale graduated in pH values, and electrodes.

As a reminder, the glass electrode must be kept in distilled water. The calomel/saturated potassium chloride electrode must be kept in a saturated potassium chloride solution. A combined electrode is most frequently used: it should be kept in distilled water.

4.2 Conical flask 100 ml.

5. Procedure

5.1 Preparation of sample:

Introduce 200 g of accurately weighed rectified concentrated must. Make up to the mark with 500 ml water. Homogenize.

5.2 Potentiometric titration

5.2.1 Zeroing of the apparatus

Zeroing is carried out before any measurement is made, according to the instructions provided with the apparatus used.

5.2.2 Calibration of the pH meter

The pH meter must be calibrated at 20°C using standard buffer solutions traceable to the SI. The pH values selected must encompass the range of values that may be encountered in musts. If the pH meter used is not compatible with calibration at sufficiently low values, a verification using a standard buffer solution linked to the SI and which has a pH value close to the values encountered in the musts may be used.

5.2.3 Method of measurement

Into a conical flask (4.4), introduce a 50 ml of the sample, prepared as described in 5.1.

Add about 10 ml of distilled water and then add the 0.1 M sodium hydroxide solution (3.2) from the burette until the pH is equal to 7 at 20 °C. The sodium hydroxide must be added slowly and the solution stirred continuously.

Let n ml be the volume of 0.1 M NaOH added.

5.3 Titration with indicator (bromothymol blue)

5.3.1 Preliminary test: end-point colour determination.

COMPENDIUM OF INTERNATIONAL ANALYSIS OF METHODS - OIV
Total acidity

Into a conical flask (4.4) place 25 ml of boiled distilled water, 1 ml of bromothymol blue solution (3.3) and 50 ml of the sample prepared as in (5.1).

Add the 0.1 M sodium hydroxide solution (3.2) until the colour changes to blue-green.

Then add 5 ml of the pH 7 buffer solution (3.1)

5.3.2 Measurement

Into a conical flask (4.4) place 30 ml of boiled distilled water, 1 ml of bromothymol blue solution (3.3) and 50 ml of the sample, prepared as described in 5.1.

Add 0.1 M sodium hydroxide solution (3.2) until the same colour is obtained as in the preliminary test above (5.3.1).

Let n ml be the volume of 0.1 M sodium hydroxide added.

6. Expression of results

6.1 Method of calculation

- The total acidity expressed in milliequivalents per kilogram of rectified concentrated must is given by: $A = 5 \times n$

- The total acidity expressed in milliequivalents per kilogram of total sugars is given by:

$$A = (500 \times n)/P$$

P = % concentration (m/m) of total sugars.

It is recorded to one decimal place.

7. Characteristics of the method

Repeatability (r)

$$r = 0.4 \text{ meq /kg total sugars}$$

Reproducibility (R)

$$R = 2.4 \text{ meq /kg total sugars}$$

OIV-MA-F1-06

Type IV method

pH
(Oeno 419A-2011)

1. Principle

The difference in potential between two electrodes immersed in the liquid under test is measured. One of these two electrodes has a potential which is a function of the pH of the liquid, while the other has a fixed and known potential and constitutes the reference electrode.

2. Reagents

2.1 Buffer solutions

2.1.1 Saturated solution of potassium hydrogen tartrate, containing at least 5.7 g of potassium hydrogen tartrate per litre ($C_4H_5KO_6$) at 20 °C. (This solution may be kept for up to two months by adding 0.1 g of thymol per 200 ml.)

pH/temperature

3.57 at 20 °C

3.56 at 25 °C

3.55 at 30 °C

2.1.2 Solution of potassium hydrogen phthalate, 0.05 M, containing 10.211 g of potassium hydrogen phthalate ($C_8H_5KO_4$) per litre at 20 °C.

(Maximum keeping period, two months.)

pH/temperature

3.999 at 15 °C

4.003 at 20 °C

4.008 at 25 °C

4.015 at 30 °C

2.1.3 Solution containing:

monopotassium phosphate, KH_2PO_4	3.402 g
dipotassium phosphate, K_2HPO_4	4.354 g
water to	1 000 ml

(maximum keeping period, two months)

pH/temperature

6.90 at 15 °C

6.88 at 20 °C

6.86 at 25 °C

6.85 at 30 °C

Note: commercial reference buffer solutions traceable to the SI may be used.

For example: pH 1.679 ± 0.01 at 25°C

pH 4.005 ± 0.01 at 25°C

pH 7.000 ± 0.01 at 25°C

3. Apparatus

3.1 pH meter with a scale calibrated in pH units and enabling measurements to be made to at least ± 0.01 .

3.2 Electrodes:

3.2.1 Glass electrode.

3.2.2 Calomel-saturated potassium chloride reference electrode

3.2.3 Or a combined electrode.

4. Procedure

4.1 Preparation of the sample for analysis

Dilute the rectified concentrated must with water to produce a concentration of 25 ± 0.5 % (m/m) of total sugars (25 ° Brix).

If P is the percentage concentration (m/m) of total sugars in the rectified concentrated must, weigh a mass of:

$$2500/P$$

and make up to 100 g with water.

The water used must have a conductivity below 2 microsiemens per cm.

4.2 Zeroing of the apparatus

Zeroing is carried out before any measurement is made, according to the instructions provided with the apparatus used.

4.3 Calibration of the pH meter

The pH meter must be calibrated at 20°C using standard buffer solutions traceable to the SI. The pH values selected must encompass the range of values that may be encountered in musts. If the pH meter used is not compatible with calibration at sufficiently low values, a verification using a standard buffer solution linked to the SI and which has a pH value close to the values encountered in the musts may be used.

4.4 Determination

Dip the electrode into the sample to be analysed, the temperature of which should be between 20 and 25 °C and as close as possible to 20 °C.

Read the pH value directly off the scale.

Carry out at least two determinations on the same sample.

The final result is taken to be the arithmetic mean of two determinations.

5. Expression of results

The pH of the 25 % (m/m) (25 ° Brix) solution of rectified concentrated must is quoted to two decimal places.

6. Characteristics of the method

Repeatability (r)

$$r = 0.07$$

Reproducibility (R)

$$R = 0.07$$

Method OIV-MA-F1-07

Type IV method

Sulphur dioxide
(Oeno 419B-2011)

1. Definitions

Free sulphur dioxide is defined as the sulphur dioxide present in the must in the following forms: : H_2SO_3 , HSO_3^-

The equilibrium between these forms is a function of pH and temperature:

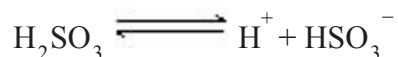

H_2SO_3 represents molecular sulphur dioxide.

Total sulphur dioxide is defined as the total of all the various forms of sulphur dioxide present in the must, either in the free state or combined with its constituents.

2. Materials

Total sulphur dioxide is extracted from the previously diluted rectified concentrated must by entrainment at high temperature (approximately 100 °C).

2.1 Reagents

2.1.1 Phosphoric acid, 85 % (H_3PO_4) ($\rho_{20} = 1.71 \text{ g/ml}$) .

2.1.2 Hydrogen peroxide solution, 9.1 g H_2O_2 /litre (three volumes).

2.1.3 Indicator reagent:

methyl red	100 mg
methylene blue	50 mg
alcohol 50 % vol.	100 ml

2.1.4 Sodium hydroxide solution (NaOH), 0.01 M.

2.2 Apparatus

2.2.1 The apparatus used should conform to the diagram shown below, particularly with regard to the condenser.

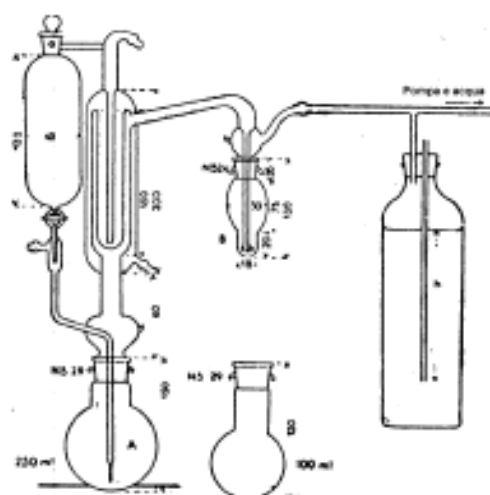

Fig. 1 The dimensions given are in millimetres. The internal diameters of the four concentric tubes forming the condenser are 45, 34, 27 and 10 mm.

The gas feed tube to the bubbler B ends in a small sphere of 1 cm diameter with 20 0.2-mm diameter holes around its largest horizontal circumference. Alternatively, this tube may end in a frit glass plate which produces a large number of very small bubbles and thus ensures good contact between the liquid and gaseous phases.

The gas flow through the apparatus should be approximately 40 litres per hour. The bottle on the right of the diagram is intended to restrict the pressure reduction produced by the water pump to 20 to 30 cm of water. To regulate the vacuum to its correct value, a flowmeter with a semi-capillary tube should be installed between the bubbler and the bottle.

2.2.2 A microburette.

3. Procedure

3.1 For rectified concentrated musts, use the solution obtained by diluting the sample to be analysed to 40 % (m/v) as indicated in the chapter 'Total acidity', section 5.1. Introduce 50 ml of this solution and 5 ml of phosphoric acid (2.2.1) into the 250 ml flask A of the entrainment apparatus. Connect the flask to the apparatus.

3.2 Place 2 to 3 ml of hydrogen peroxide solution (2.2.2) in the bubbler B, neutralize with the 0.01 M sodium hydroxide solution (2.2.4) and bring the must in the flask A to the boil using a small flame of 4 to 5 cm height which should directly touch the bottom of the flask. Do not put the flask on a metal plate but on a disc with a hole of approximately 30 mm diameter in it. This is to avoid overheating substances extracted from the sample that are deposited on the walls of the flask.

Maintain boiling while passing a current of air (or nitrogen). Within 15 minutes the total sulphur dioxide has been carried over and oxidized. Determine the sulphuric acid which has formed by titration with the 0.01 M sodium hydroxide solution (2.2.4).

Let n ml be the volume used.

4. Calculation

Total sulphur dioxide in milligrams per kilogram of total sugars (50 ml prepared test sample (3.1):

$$(1600 \times n)/P$$

where P = percentage concentration (m/m) of total sugars

5. Expression of results

Total sulphur dioxide is expressed in mg/kg of total sugars.

6. Characteristics of the method

Repeatability (r)

50 ml test sample < 50 mg/l; $r = 1 \times 250/P$ mg/kg of total sugars

Reproducibility (R)

50 ml test sample < 50 mg/l; $R = 9 \times 250/P$ mg/kg of total sugars

Method OIV-MA-F1-08

Type IV method

Chromatic Properties
(Oeno 419A-2011)

1. Principle of the method

The absorbance of the rectified concentrated must is measured at 425 nm through a pathlength of 1 cm after dilution to bring the sugar concentration to 25 % (m/m) (25° Brix)

2. Apparatus

2.1 Spectrophotometer enabling measurements to be made between 300 and 700 nm.

2.2 Glass cells with optical paths of 1 cm.

2.3 Membrane filter of pore diameter 0.45 µm.

3. Procedure

3.1 Preparation of the sample

Use the solution with a sugar concentration of 25 % (m/m) (25° Brix) prepared as described in the chapter 'pH', section 4.1. Filter through a membrane filter of pore diameter 0.45 µm.

3.2 Determination of absorbance

Zero the absorbance scale at a wavelength of 425 nm using a cell with an optical path of 1 cm containing distilled water.

Measure the absorbance *A* at the same wavelength of the solution containing 25 % sugar (25° Brix) prepared as in 3.1 and placed in a cell with an optical path of 1 cm.

4. Expression of results

The absorbance at 425 nm of the rectified concentrated must in a solution with 25 % sugar (25° Brix) is quoted to two decimal places.

Repeatability (*r*)

$$r = 0.01 \text{ AU at } 25^\circ \text{Brix}$$

Method OIV-MA-F1-09

Type I Method

Specific methods for the analysis of grape sugar
(Resolution Oeno 419B/2012)

ANNEX A: TOTAL CATIONS

1. PRINCIPLE

The test sample is treated by a strongly acid cation exchanger. The cations are exchanged with H⁺. Total cations are expressed by the difference between the total acidity of the effluent and that of the test sample.

2. APPARATUS

- 2.1. Glass column of internal diameter 10 to 11 mm and length approximately 300 mm, fitted with a drain tap.
- 2.2. pH meter with a scale graduated at least in 0.1 pH units.
- 2.3. Electrodes:
 - glass electrode, kept in distilled water,
 - calomel/saturated potassium chloride reference electrode, kept in a saturated solution of potassium chloride,
 - or a combined electrode, kept in distilled water.

3. *REAGENTS*

- 3.1. Strongly acid cation exchange resin in H⁺ form pre-swollen by soaking in water overnight.
- 3.2. Sodium hydroxide solution, 0.1 M.
- 3.3. Paper pH indicator.
- 3.4. The water used must be purified water for laboratories, with specific conductivity below 2 µS cm⁻¹ at 20°C, for example EN ISO 3696 type II water.

4. *PROCEDURE*

The pH meter must be calibrated according to the method OIV MA AS313-15

4.1. Preparation of sample

Use the solution obtained by diluting the rectified concentrated must to 40% (m/v). Introduce 200 g of accurately weighed rectified concentrated must. Make up to the mark with 500 ml water. Homogenize.

4.2. Total acidity of the rectified concentrated must

Titrate the acidity of the concentrated must in 100 ml of sample prepared as in 4.1 with the 0.1M sodium hydroxide solution until the pH is equal to 7 at 20 °C. The alkaline solution should be added slowly and the solution continuously shaken. Let n1 ml be the volume of 0.1 M sodium hydroxide solution used.

4.3. Preparation of the ion exchange column

Introduce into the column approximately 10 ml pre-swollen ion exchanger in H⁺ form. Rinse the column with distilled water until all acidity has been removed, using the paper indicator to monitor this.

4.4. Ion exchange

Pass 100 ml of the rectified concentrated must solution prepared as in paragraph 4.1 through the column at the rate of one drop every second. Collect the effluent in a beaker. Rinse the column with 50 ml of distilled water. Titrate the acidity in the effluent (including the rinse water) with the 0.1 M sodium hydroxide solution until the pH is 7 at 20°C. The alkaline solution should be added slowly and the solution continuously shaken. Let n₂ ml be the volume of 0.1 M sodium hydroxide solution used.

5. *EXPRESSION OF THE RESULTS*

The total cations are expressed in milliequivalents per kilogram of total sugar to one decimal place.

5.1. Calculations

– Total acidity of the rectified concentrated must in milliequivalents per kilogram:

$$a = 2.5 n_1$$

– Acidity of the effluent expressed in milliequivalents per kilogram of rectified concentrated must:

$$E = 2.5 n_2.$$

– Total cations in milliequivalents per kilogram of total sugars:

$$((n_2 - n_1) / (P)) \times 250$$

P = percentage concentration (m/m) of total sugars.

5.2 Repeatability (r)

$$r = 0.3$$

Method OIV-MA-F1-10

Type IV Method

Specific methods for the analysis of grape sugar
(Resolution Oeno 419B/2012)

ANNEX D: HEAVY METALS

Type IV

D.1 DETERMINATION OF LEAD LEVEL BY ETAAS

Heavy metals are described in detail in the steps for preparing grape sugar samples (concentrated musts and MCR rectified concentrated musts) for determining lead content.

The instrumentation and computer tools used in the testing laboratories vary and change.

As a result, general criteria for calibration and metrics are given.

1. Warning

SECURITY PRECAUTIONS – Operators must protect their hands and eyes when handling acids. Acids must be handled under an appropriate fume hood.

2. Scope

This method specifies an electrothermal atomic absorption spectrometry method (ETAAS) for determining the lead content of rectified concentrated musts between 10 µg/kg to 200 µg/kg.

3. Normative references

ISO 3696, Water for analytical laboratory use — Specification and test methods

4. Principle

In Electrothermal Atomic Absorption Spectrometry (ETAAS), a sample volume is inserted into a graphite tube which may be heated to over 2800°C. When the temperature is gradually increased, the sample matrix dries and thermal decomposition and dissociation occur. For most elements, the peak height is proportional to the concentration of the element in the solution, although in a very large number of cases, it is preferable to work with the peak area.

5. Reagents and solutions

Unless otherwise indicated, only use lead-free reagents of recognised analytical quality.

5.1 Demineralised, ultra-pure water with resistivity above 18 MΩ, following ISO 3696.

5.2 Nitric acid of a concentration above 60% (Normapur quality).

5.3 Ammonium dihydrogen phosphate $\text{NH}_4\text{H}_2\text{PO}_4$

5.4 Matrix modifier: $\text{NH}_4\text{H}_2\text{PO}_4$, 6% solution

Pour 3g of $\text{NH}_4\text{H}_2\text{PO}_4$ into a 50 ml volumetric flask. Dissolve and bring to volume with demineralised water.

5.5 Magnesium nitrate $\text{Mg}(\text{NO}_3)_2$ to 6 molecules of water

5.6 0.5% magnesium nitrate solution (keep refrigerated).

Pour 0.5g of magnesium nitrate into a 100 ml volumetric flask. Dissolve and bring to volume with demineralised water. Keep this solution refrigerated for a maximum of 15-20 days.

5.7 Certified mono element lead solution(s) (at 1000 mg/l)

5.8 10 mg/l lead solution

Place 1 ml of the stock solution (5.7) and 10 ml of nitric acid (5.2) in a 100 ml flask. Bring to volume with ultra-pure water (5.1).

5.9 100 µg/l lead solution

Place 1 ml of the stock solution (5.8) in a 100 ml flask. Add 10 ml of nitric acid (5.2). Bring to volume with ultra-pure water (5.1).

5.10 Triton X-100 (1% v/v)

5.11 Blank test: 10% nitric acid

Preparation of the calibration range

The number of calibration solutions depends on the required precision. At least five standards are required. The precision and accuracy of the results may be verified by analysing a control sample.

It should be stressed that the linearity of the calibration curve is often limited.

Correct the absorbance values of the calibration solutions by subtracting the absorbance value of the blank test. To plot a calibration curve or calculate the calibration function, use the values obtained as well as the analyte concentration of the calibration solutions.

Depending on the type of apparatus, it is possible to work with an autosampler to direct inject predetermined volumes from the 100 µg/l solution in order to have a calibration range of 0 to 100 µg/l (e.g. 0, 10, 25, 50, 100 µg/l). It is also possible to prepare calibration solutions separately.

Note 1: A smaller volume of test sample may be used to determine lead content greater than 100 µg/l.

6. Apparatus and equipment

6.1 **Atomic absorption spectrometer** equipped with an electrothermal atomiser, a hollow-cathode lamp adapted for lead functioning with the manufacturer-recommended current, an automatic correction device for background noise and a computer reading system or high-speed graphic recorder. A correction of background noise should be used with electrothermal atomic absorption spectrometry. The minimum acceptable technical specification is based on deuterium. A correction of the Zeeman background noise is preferable if the signal from background noise is high. To increase the analyte signal-to-noise ratio, the use of a graphite tube with a pyrolytic platform is recommended.

Note 2: a wavelength of 217.0 nm can be used for lead. The sensitivity is about two times higher than that obtained at 283.3 nm. However, since the noise and risk of interference are greater, it is necessary to work with a Zeeman background noise correction system.

6.2 Precision balance accurate to 0.1 mg

6.3 Class A graduated pipettes: 0.5 ml, 1 ml, 5 ml

6.4 Class A volumetric flasks: 50 ml and 100 ml

Note 3: the material in contact with the sample must remain in a 10% nitric acid solution (5.2) for at least 12 hours and must be subsequently rinsed several times with demineralised water (5.1).

7. Sampling

Preparation of the sample for testing

In a 50 ml flask (6.4), pour 10 g of the sample accurate to 0.1 mg, 5 ml of nitric acid (5.2), and 0.5 ml of triton X-100 (1% v/v) (5.10). Bring to 50 ml with the demineralised water (5.1) and homogenise.

8. Procedure

Adjust the instrumental parameters and align the electrothermal atomiser following the manufacturer's instructions in order to derive maximum benefit from the background noise correction system. Adjust the sampler in the same way. Determine the optimal parameters for the electrothermal atomiser for the particular type of atomiser and sample volume, as recommended by the apparatus manufacturer, in order to cover the optimal measuring range. Adjust the baseline of the apparatus to zero. Verify the stability of zero in the atomisation system by executing the predefined temperature programme for the white heating of the graphite atomiser. The following furnace settings may be used:

phase	temperature (°C)	level-off (s)	rise (ramp) (°C/s)	type of gas	gas speed (l/mn)	reading
1	130	15	10	argon	0.2	no
2	350	5	25	argon	0.2	no
3	500	5	50	argon	0.2	no
4	750	10	100	argon	0.2	no
5	1900	3	0	argon	stopped	yes
6	2500	3	0	argon	0.2	no
7	100	10	0	argon	0.2	no

Using an autosampler, inject a set volume of the solution. Add a set volume of modifier solution and atomise the blank test (5.11), the calibration solutions and the diluted test sample solutions by order of increasing response of the apparatus. If the peak height (or the peak area) of the test sample is greater than the value of the calibration solution with the highest concentration, a lower test sample volume must be used.

External calibration

The following programme for the sampler is given as an example (volume in µl) to determine the lead content through external calibration.

	blank test	sample	standard 1 10 µg/l	standard 2 25 µg/l	standard 3 50 µg/l	standard 4 100 µg/l
blank (HNO ₃ 10%)	5.0					
thinner (HNO ₃ 10%)			4.5	3.7	2.5	0
sample		5.0				
stock solution (Pb 100 µg/l)			0.5	1.3	2.5	5.0
NH ₄ H ₂ PO ₄ 6%	4.0	4.0	4.0	4.0	4.0	4.0
Mg(NO ₃) ₂ 0.5%	2.0	2.0	2.0	2.0	2.0	2.0
total volume	11.0	11.0	11.0	11.0	11.0	11.0

Atomise each solution at least two times and, if the reproducibility is acceptable in compliance with the quality control system used in the laboratory, calculate the average of readings. If necessary, reset the baseline to zero.

Addition method

It is also possible to use the addition method to reduce the effect of non-spectral interferences between the standards and the samples, as long as the calibration curve is linear in the absorbance range used.

Transfer identical volumes of the testing sample in three receptacles (for example, autosampler cups). Add a small quantity of standard solution to two of the receptacles, calculated in order to obtain a concentration for the samples, respectively, of between 100% and 200% higher than the concentration in the original sample. Add the same quantity of water in the third receptacle. Carefully mix the solutions. Measure the integrated absorbance of each solution and plot a curve with the added concentration on the *x*-axis and the measured absorbance on the *y*-axis. Determine the analyte concentration of the reagent blank solution or the test blank solution in the same manner.

The following programme for the sampler is given as an example (volume in µl) to determine the lead content using the addition method.

	blank test	sample	addition 1 25 µg/l	addition 2 50 µg/l
blank (HNO ₃ 10%) thinner (HNO ₃ 10%) sample stock solution (Pb 100 µg/l)	5.0			
NH ₄ H ₂ PO ₄ 6 %	2.5	2.5	1.2	0
Mg(NO ₃) ₂ 0.5%		5.0	5.0	5.0
total volume			1.3	2.5
	1.0	1.0	1.0	1.0
	2.0	2.0	2.0	2.0
	10.5	10.5	10.5	10.5

9. Calculation

The apparatus software establishes the calibration graph (absorbance as a function of lead concentration in µg/l). It gives the lead concentration of the samples. Take into account any dilution, if applicable.

10. Precision parameters

For a lead concentration inferior to 150 µg/kg:

r (Repeatability) = 15 µg/kg

R (Reproducibility) = 25 µg/kg

11. Bibliography

13.1 Laboratoire SCL33. *Détermination du plomb dans le vin par atomic absorption spectrometry (four-graphite)*. Manuel d'instructions, 2010.

13.2 Laboratoire SCL33. *Détermination du plomb dans les aliments solides par atomic absorption spectrometry (four-graphite)*. Manuel d'instructions, 2010.

13.3 Rodriguez Garcia J.C. *Desarrollo de metodologías para la determinación de metales en miel mediante ETAAS y estudio quimiométrico de su empleo como bioindicador*. Universidad de Santiago de Compostela, Facultad de Ciencias, Campus de Lugo, 2006.

Method OIV-MA-F1-11

Type IV Method

Specific methods for the analysis of grape sugar
(Resolution Oeno 419B/2012)

ANNEX D.2: HEAVY METALS

Determination of lead content by Inductively Coupled Plasma Mass Spectrometry (ICP-MS).

The analysis of Pb in rectified concentrated grape musts can also be performed applying the **method OIV/OENO344/2010** (Multielemental Analysis Using ICP-MS), with the following modification added at the end of point N°5 (Sample preparation):

5. SAMPLE PREPARATION

This method can also be applied to the analysis of Pb in rectified concentrated grape musts. For this purpose, a prior mineralisation of the sample is required. A digestion of the samples in a close vessel microwave system is recommended. The following procedure is given as a way of example:

Ad 1 g of must, 2 ml of nitric acid (3.4) and 8 ml of water (3.1) in a microwave vessel, and apply the following microwave digestion programme:

Stage	ramp	°C	Hold
1	20 min	200	20 min

Once the samples have been digested, transfer them to a 50 ml plastic tube (4.6), dilute with water (3.1) to 30g and homogenize.

Method OIV-MA-F1-12

Methode type II

Specific methods for the analysis of grape sugar
(Resolution Oeno 419C/2015)

Determination of meso-inositol, scyllo-inositol and sucrose

1. PRINCIPLE

Rectified Concentrated Must (RCM) is mainly composed of sugars, polyalcohols and water contained in grapes. All the other organic and mineral components are removed during the rectification process.

Meso-inositol, scyllo-inositol and sucrose are determined through gas chromatography (GC) following silanisation.

The sucrose possibly found in small amounts in the RCM is stable for some months since hydrolysis is greatly slowed down due to the absence of organic and mineral acids, which are removed during the rectification process, to a very low water content, and to a high level of glucose and fructose.

2. REAGENTS

2.1. Xylitol (CAS no. 87-99-0)

Internal standard: (aqueous solution of at a precisely known concentration of about 10 g/L prepared at the time).

COMPENDIUM OF INTERNATIONAL METHODS OF ANALYSIS-OIV
Specific methods for the analysis of grape sugar

- 2.2. Meso-inositol (C₆H₁₂O₆) (CAS no. 87-89-8)
- 2.3. Scyllo-inositol (C₆H₁₂O₆) (CAS no. 488-59-5)
- 2.4. Glucose (C₆H₁₂O₆), fructose (C₆H₁₂O₆), sucrose (C₁₂H₂₂O₁₁)
- 2.5. Bis(trimethylsilyl)trifluoroacetamide - (BSTFA) – (C₈H₁₈F₃NOSi₂) (CAS no. 25561-30-2)
- Warning: This is a dangerous and inflammable product. Inflammable liquids and vapours may provoke serious skin burns and serious eye lesions. Wear gloves/protective clothing. Protect your eyes/face.*
- 2.6. Trimethylchlorosilane (C₃H₉ClSi) – TMCS – (CAS no. 75-77-4)
- Warning: This is a dangerous and inflammable product. Harmful to the skin. Provokes serious skin burns and serious ocular lesions. Toxic when inhaled. May irritate the respiratory tract. Keep away from sources of heat/sparks/free flames /heated surfaces. Do not smoke. Avoid inhaling the vapours. Wear gloves/protective clothing. Protect your eyes/face.*
- 2.7. Pyridine p.a. (C₅H₅N) (CAS no. 110-86-1)
- Warning: This is a dangerous and inflammable product. Noxious when inhaled, in contact with the skin and when swallowed.*
- 2.8. Absolute ethanol (C₂H₆O) (CAS no. 64-17-5)
- Warning: This is an inflammable product. Liquid and vapours easily inflammable. Keep away from sources of heat/sparks/free flames /heated surfaces. Do not smoke.*
- 2.9. Type 1 Water in conformity with ISO 3696 standard or deionised water with resistivity ≥ 18MΩ cm
- 2.10. The silanising reagent is also available in ready to use kits (e.g. HMDS+TMSCl+Pyridine 3:1:9 Supelco cod. 33038)
- 2.11. Technical gases: nitrogen, hydrogen, helium and air for gas chromatography and for the dehydration phases

3. APPARATUS

3.1. Gas chromatograph

3.2. Capillary column able to guarantee a minimum efficiency of $N=250,000$ plates/column for sucrose at 1 g/L

For example, OV-1 (25 m x 0.30 mm x 0.15 μm) or DB-5 (60 m x 0.25 mm x 0.10 μm).

Operating conditions (only as an example):

carrier gas: pure hydrogen or helium, for gas chromatography,

Hydrogen: *Warning: This is an extremely inflammable gas. Store the container in a well-ventilated place and far from flames and sparks. – Do not smoke. Avoid the piling up of electrostatic loads.*

carrier gas flow rate: about 2 mL/min,

injector temperature: 250 °C,

temperature of flame ionisation detector (FID): 300 °C,

programming of temperature: 1 minute at 160 °C, 4 °C/minute up to 260 °C, constant temperature of 260 °C for 15 minutes,

splitter ratio: about 1:20,

auxiliary gases: pure hydrogen and air for gas chromatography.

3.3. Integrator

3.4. Microsyringe: 10 μL

3.5. Micropipettes: 10, 100, 400 and 1000 μL

3.6. 2 mL flasks with Teflon stopper

- 3.7. Oven
- 3.8. Technical balance, analytical balance able to ensure an accuracy of ± 0.1 mg
- 3.9. Flasks of 50 and 100 mL
- 3.10. Dryer

4. PROCEDURE

4.1 Preparation of the sample

In a 50 mL flask, weigh a quantity “p” of rectified concentrated must ranging between 4.9 and 5.1 g, noting the weight of the substance with the precision of ± 0.1 mg.

Then add 1 mL of xylitol standard solution (2.1) and bring to volume with water (2.9).

4.2 Dehydration of the sample

After mixing, 100 μ L of solution is taken and placed in a flask (3.6) where it is dried under a gentle stream of nitrogen.

100 μ L of absolute ethanol (2.8) may be added to facilitate evaporation.

Note 1: In case a precise dose of sucrose is desired, the diluted solution should be prepared just before the silanisation, in order to limit hydrolysis of the sucrose in the diluted aqueous solution.

Note 2: The repeated measurements of the sucrose content have to be performed on diluted solutions prepared every time before every silanisation.

4.3 Derivatization

The residue is carefully dissolved in 100 μL of pyridine (2.7) and 100 μL of bis (trimethylsilyl)trifluoroacetamide (2.5) and 10 μL of trimethylchlorosilane (2.6) are added. The flask is closed with the Teflon stopper and placed in the oven at 70 °C for 70 minutes.

Take the sealed flasks out of the oven and leave to cool in the dryer in the dark at room temperature for an hour before injecting into the gas chromatograph.

The substance conserved in the sealed flask and kept in the dryer in the dark at room temperature is stable for three days.

Note 3: If working with a silanisation kit, 400 μL of reagent should be used per 100 μL of the dehydrated and diluted sample, as described in 4.1.

Note 4: The silanisation is considered successful if the solution, after a sole phase, has a clear appearance or leaves a slight, white residue. There should not be a dark residue since this would indicate an excess of non-derivatised sugar or an aged silanising substance.

Note 5: Should there be a white suspension, wait until the solid matter deposits on the bottom without centrifuging.

4.4 Gas chromatographic analysis

1 μL is taken with a syringe (3.4) and injected into the chromatograph with the aforementioned splitter.

The chromatogramme should not show a confluence of peaks (sign of a badly performed silanisation), but characteristic peaks as shown in the attached figures. (Fig.9-Fig.12).

4.5 Peak integration criteria

Integrate the gas chromatographic peaks with respect to the horizontal baseline. In case of peaks that are not perfectly resolved, trace the horizontal baseline starting from the deeper valleys that delimit the peak

in question. Trace a vertical line downwards starting from the valleys of the peaks up to the baseline to identify the peak area.

Do not use the valley-valley integration method.

An example of the application of these criteria is given in Figure 10 for the internal standard, in Figure 11 for the inositols and in Figure 12 for the sucrose.

Note 6: In case a precise dose of sucrose is desired, it is important to respect the integration criteria explained in paragraph 4.4. and shown in Figure 4.

5. CALCULATIONS

5.1. Calculation of response factors

Note: instead of the calculation of response factors a calibration curve can be used

5.1.1 A solution is prepared containing:

- 60 g/L of glucose,
- 60 g/L of fructose,
- 1 g/L of meso-inositol,
- 1 g/L of sucrose,

(weigh 60 g of glucose and 60 g of fructose with precision ± 1 g; then 1 g of meso-inositol and 1 g of sucrose with precision ± 0.1 mg) and lastly bring to volume of 1 litre with water.

5.1.2 Silanisation of the reference solution

Carry out the operations described in paragraph 4.1 starting with 5 mL of said solution in place of the 5 g of RMC

Take 5 mL of the solution and proceed as in paragraph 4.

5.1.3 Gaschromatographic response factors

The results for meso-inositol and sucrose with respect to xylitol are calculated from the chromatogram.

In the case of scyllo-inositol, which has a retention time lying between the last peak of the anomeric form of glucose and the peak for meso-inositol (see Figure 11), use the same response factors achieved for meso-inositol.

Where: $A_{\text{meso-inositol}}$ = area of the meso-inositol peak; A_{sucrose} = area of the sucrose peak; A_{is} = area of the internal standard peak; $C_{\text{meso-inositol}}$ = concentration of meso-inositol in mg/L; C_{sucrose} = concentration of sucrose in mg/L; C_{is} = concentration of internal standard in mg/L, the following formula is true:

$$RF_{\text{meso-inositol}} = \frac{A_{\text{meso-inositol}}}{A_{\text{is}}} \times \frac{C_{\text{is}}}{C_{\text{meso-inositol}}}$$

$$RF_{sucrose} = \frac{A_{sucrose}}{A_{is}} \times \frac{C_{is}}{C_{sucrose}}$$

The solution for the calculation of the response factors has to be prepared and analysed on the same day (see note 1 of paragraph 4.1).

5.2. Formulation of the results

Meso-inositol, scyllo-inositol and sucrose are expressed in mg/kg of Total Sugars (mg/kg TS) without decimals.

5.2.1 Concentrations expressed in mg/L for the 10% (w/v) solution of RCM (4.1):

$$C_{meso-inositol} \left(\frac{mg}{l} \right) = \frac{C_{is}}{RF_{meso-inositol}} \times \frac{A_{meso-inositol}}{A_{is}}$$

$$C_{sucrose} \left(\frac{mg}{l} \right) = \frac{C_{is}}{RF_{sucrose}} \times \frac{A_{sucrose}}{A_{is}}$$

5.2.2 Concentrations expressed in mg/kg of Total Sugars (mg/kg TS) for the meso-inositol and the scyllo-inositol, and for the sucrose in the RCM.

Indicating with “i” any of the three compounds:

$$CONC_i \left(\frac{mg}{kg TS} \right) = C_i \times \frac{5000}{w \times G}$$

Where “w” is the weighed amount in g of the RCM and “G” is the percentage of sugar of the RCM expressed in °Brix [or % (m/m) of sucrose]. The sugar percentage of the RCM sample should be measured using the OIV-MA-AS2-02 method.

6. CHARACTERISTICS OF THE METHOD

6.1 Critical points

The method regards the analysis of sugars and polyalcohols found in extremely small quantities in a matrix of glucose and fructose in very high concentrations. It is thus necessary to verify the method’s capacity to furnish linear responses in the range of concentrations proposed and that are sufficiently accurate compared with known values.

Furthermore, the method provides for gas chromatographic analysis of the silanised compounds obtained through derivatisation of the sugars. These compounds are sensitive to humidity and tend to deteriorate with time. It is therefore important to verify the adequacy of the instructions regarding conservation and handling of these compounds.

Lastly, sucrose is subject to hydrolysis due to the quantity of residual water in the RCM (from 30 to 45%). However, the low acidity of the matrix and the high concentration of glucose and fructose slow down the hydrolysis process and allow accurate measurements to be carried out. It is therefore important to check that the analysis timeframes are fast compared to the hydrolysis in order to allow repeatable measurements of the sucrose.

6.2 Linearity

A series of six synthetic samples were prepared (including the blank) containing a matrix of glucose and fructose obtained by weighing equal quantities of the two sugars in relation to a 60% (w/w) content of total sugars in the initial RCM.

To five of these synthetic samples, precise amounts in increasing quantities of meso-inositol and sucrose were added so as to achieve the concentrations shown in the following table:

concentration added		
No.	meso-inositol (mg/kg TS)	sucrose (mg/kg TS)
1	0 (blank)	0 (blank)
2	214.7	427.3
3	420.0	857.7
4	840.2	1675.8
5	1727.0	3338.0
6	2514.0	6719.0

The samples were then diluted (4.1), the diluted solution was dehydrated (4.2), silanised (4.3) and analysed with the GC (4.4-4.5).

The samples were then silanised and analysed using GC. The results were verified in order of linearity, showing on the graph the ratio between the peak areas of the meso-inositol peaks and that of the internal standard ($A_{\text{meso}}/A_{\text{s}}$), and the ratio between the concentration of meso-inositol and of the internal standard (in mg/L), indicated by $C_{\text{meso}}/C_{\text{is}}$. The GC analysis was conducted twice and the following data refer to the mean of the two values.

The same treatment was applied to the sucrose as follows

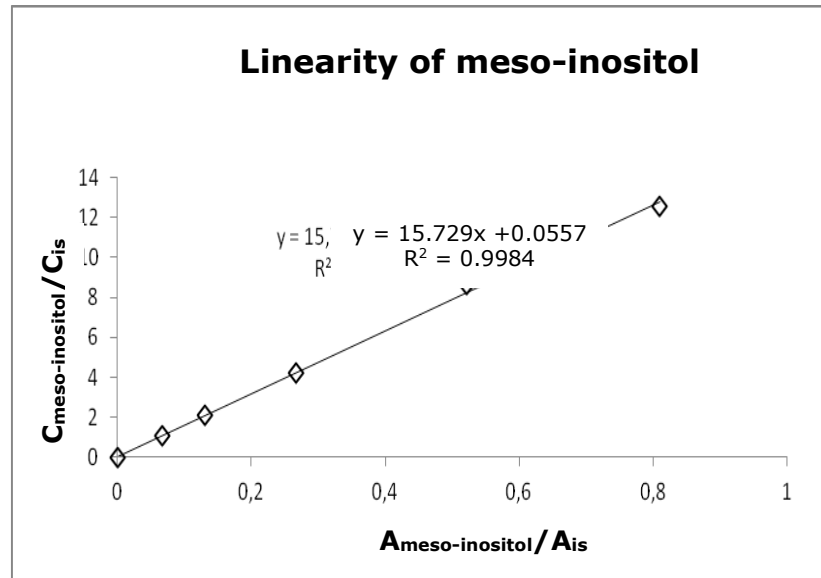

Fig. 1 Linearity of meso-inositol

The linearity of the meso-inositol is highly satisfactory ($R > 0.998$) in the entire range of concentration studied.

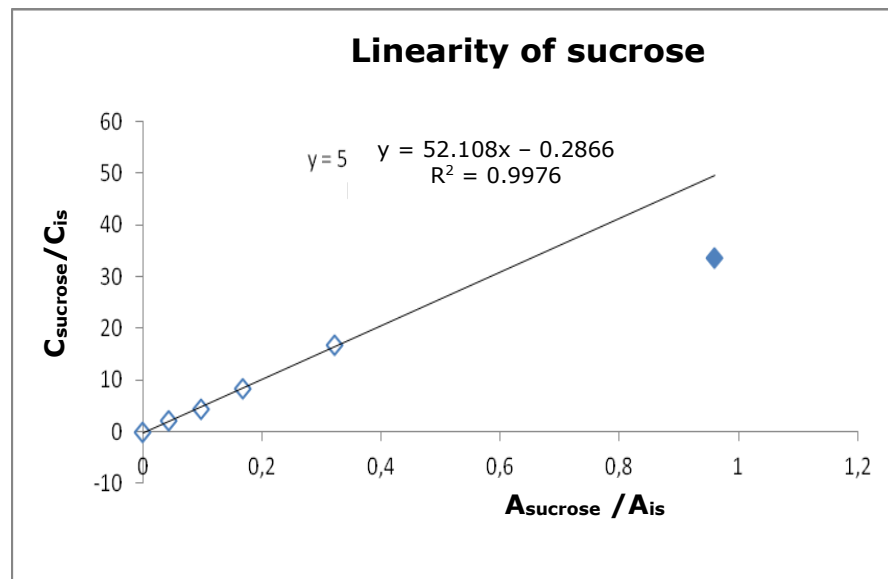

Fig. 2 Linearity of sucrose

In relation to sucrose, the linear relationship hypothesised over the entire range of concentrations studied did not lead to a satisfactory correlation ($R=0.967$) but, by narrowing down the linearity field to the synthetic sample no. 5, the correlation became comparable to that of meso-inositol ($R>0.997$).

Following the instructions in par. 5.1, the following response factors were obtained:

RF rel. Meso-inositol/Xylitol I.S.	RF rel. Sucrose/Xylitol I.S.
1.04 ± 0.03 (mean $\pm \sigma$; n=4)	0.36 ± 0.06 (mean $\pm \sigma$; n=4)

6.3 Specificity

The relationship between the added meso-inositol and that determined by GC is linear in the entire measurement range studied, and the slope of the line is very close to one and intercept is very close to zero.

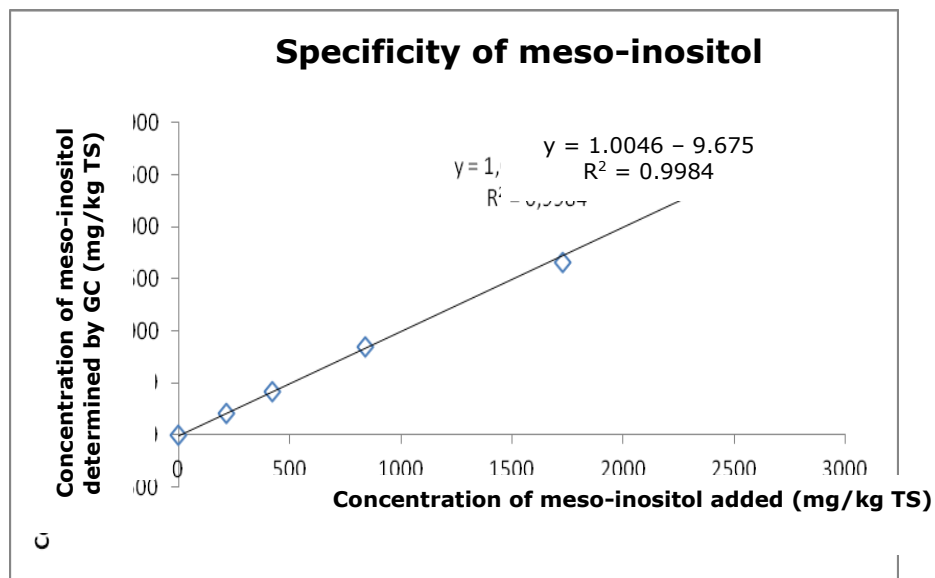

Fig. 3 Specificity of meso-inositol

Also, the recovery is satisfactory at between 95 and 105%, as seen in the following table:

$C_{\text{meso-inositol added}}$ (mg/kg TS)	$C_{\text{meso-inositol determined by GC}} \pm \sigma$ (n=2) (mg/kg TS)	Recovery (%)
0	0	-
214.7	213 ± 2	99%
420.0	419 ± 3	100%
840.2	852 ± 20	102%
1727.0	1668 ± 214	100%
2514.0	2587 ± 36	99%

As to the specificity of the sucrose, the concentrations obtained from the calculation of the added sucrose and that determined by GC conform and are in a linear relationship with each other, with a slope of one and intercept of almost zero, on the condition, however, that the concentration range is more restricted compared to that studied.

The following graph shows that the linear relationship does not extend up to the last concentration level of about 6700 mg/kg TS.

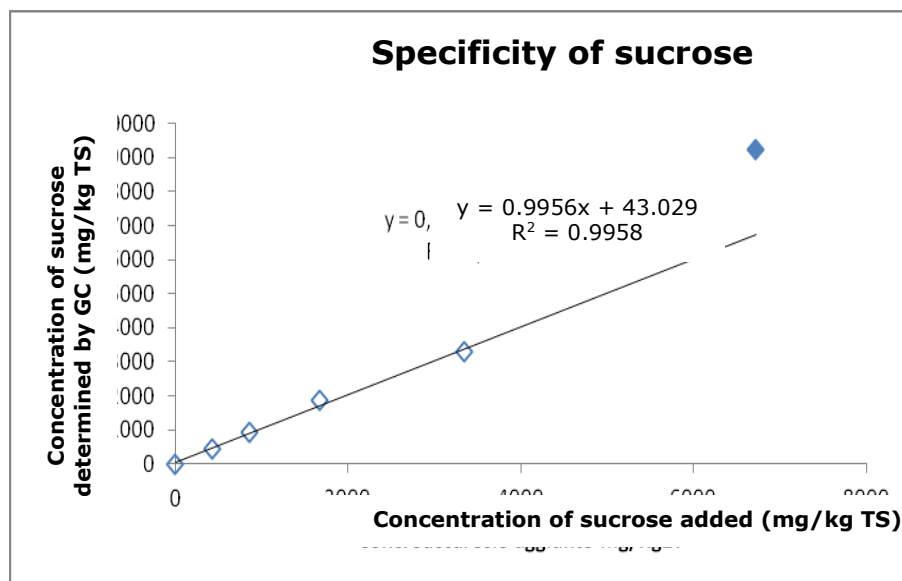

Fig. 4 Specificity of sucrose

Also, the recovery is satisfactory, at between 90 and 110%, excluding the higher concentration levels, as seen in the following table:

$C_{\text{sucrose added}}$ (mg/kg TS)	$C_{\text{sucrose determined by GC}} \pm \sigma$ (n=2) (mg/kg TS)	Recovery (%)
--	--	--------------

COMPENDIUM OF INTERNATIONAL METHODS OF ANALYSIS-OIV
Specific methods for the analysis of grape sugar

0	0	-
427.3	423 ± 16	99%
857.7	913 ± 37	107%
1675.8	1852 ± 344	111%
3338.0	3297 ± 284	99%
<u>6719.0</u>	<u>9220 ± 19</u>	<u>137%</u>

6.4 Stability of sucrose in rectified concentrated must

A sample of the RCM with added sucrose was kept at room temperature and analysed at regular time intervals in order to see the incidence of the hydrolysis phenomenon of sucrose in RCM.

The results are summarised in the following table:

	t = 0 days	t=9 days	t=53 days
Meso-inositol (mg/kg TS)	2227	2100	2052
Scyllo-inositol (mg/kg TS)	424	430	394
Sucrose (mg/kg TS)	4631	5108	4969

Both the meso-inositol and the scyllo-inositol, as well as the sucrose, do not show significant variations in concentration compared to the initial value up to 53 days after the preparation.

This fact appears to be evident in the following graph:

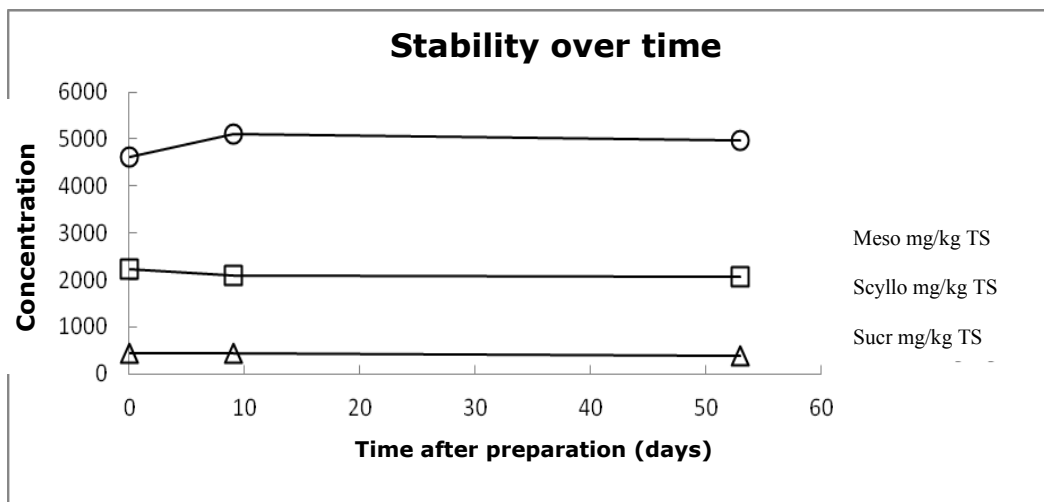

Fig. 5 Stability over time

6.5 Stability of the silanised sample

The silanised product obtained as described in point 4.2 was conserved as described in the same paragraph. At 24-hour intervals the silanised sample was analysed with the gas chromatograph following the procedure set out in point 4.3 and the succeeding points.

The results are described in the following table:

COMPENDIUM OF INTERNATIONAL METHODS OF ANALYSIS-OIV
Specific methods for the analysis of grape sugar

	t=0 mean ± SD (n=3)	t=24 h mean ± SD (n=3)	t=48 h mean ± SD (n=3)	t=72 h mean ± SD (n=3)	t=96 h mean ± SD (n=3)
Meso- inositol (mg/kg TS)	2424 ± 109	2347 ± 44	2358 ± 17	2453 ± 39	2478 ± 15
Scyllo- inositol (mg/kg TS)	261 ± 7	254 ± 2	256 ± 4	257 ± 3	264 ± 1
Sucrose (mg/kg TS)	6233 ± 971	6500 ± 200	6633 ± 58	6733 ± 321	6600 ± 436

There are no significant differences between the results obtained from the same silanised sample up to 4 days after silanisation, adopting the measures for the conservation of the silanised sample described in point 4.2.

This fact is evident in the following graphs:

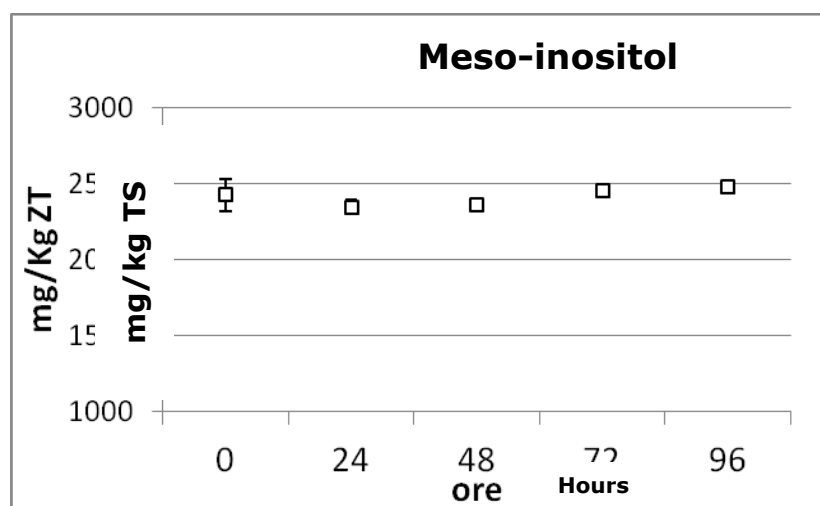

Fig. 6 Stability of Meso-inositol

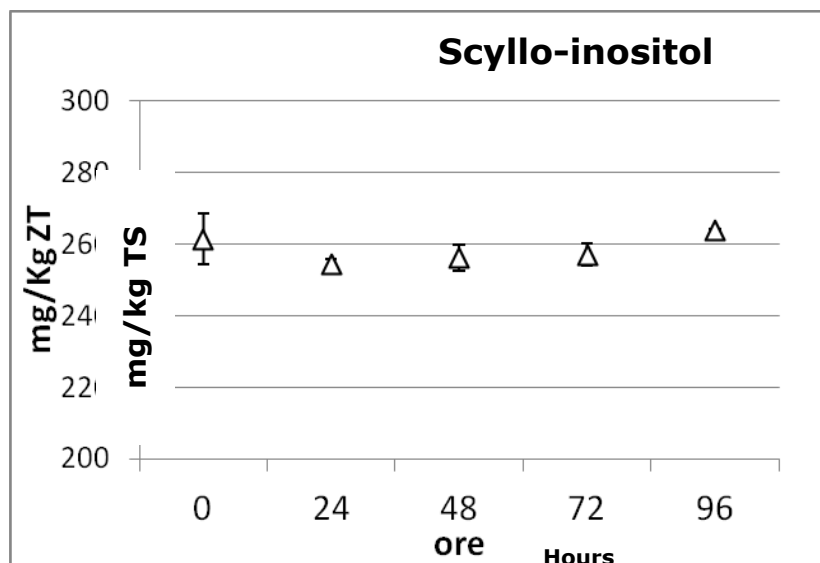

Fig. 7 Stability of Scyllo-inositol

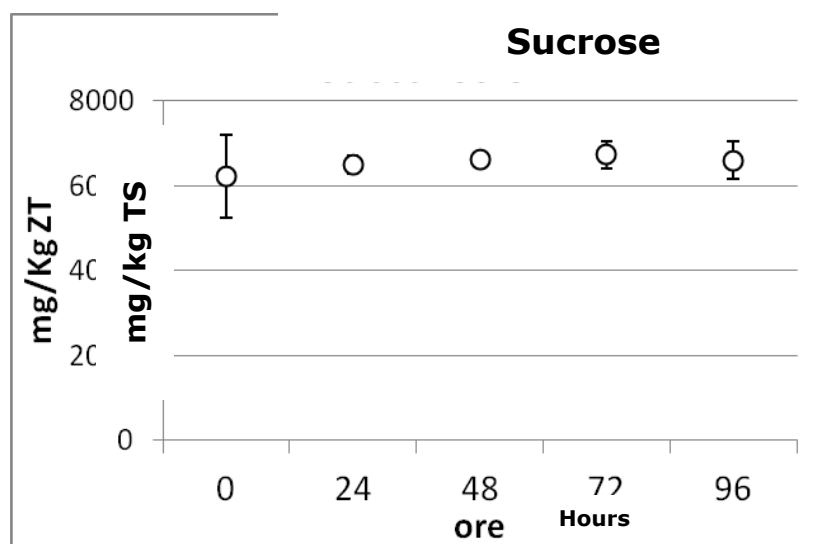

Fig. 8 Stability of Sucrose

COMPENDIUM OF INTERNATIONAL METHODS OF ANALYSIS-OIV
Specific methods for the analysis of grape sugar

6.6 Precision

Precision parameters obtained in the interlaboratory test conducted in April 2014 between 8 Italian laboratories. The Ring Test was performed on a sample with added sucrose at a concentration of 1 g of sucrose / 1 kg RCM

	sucrose	meso- inositol	scyllo- inositol
Number of participating laboratories	8	8	8
Number of accepted test results	23	23	23
Mean values (mg/kg TS)	1665	954	145
Repeatability			
Repeatability standard deviation (Sr)	78	52	11
Relative repeatability standard deviation (%RSD _r)	4.7	5.4	7.3
Repeatability limit (r)	219	146	29
HORRAT r = RSD _r / RSD(R) Horwitz	0.9	1.0	1.0
Reproducibility			
Reproducibility standard deviation (SR)	122	76	19
Relative reproducibility standard deviation (%RSD _R)	7.4	8.0	13
Reproducibility limit (R)	343	213	55
RSD(R) Horwitz %	5.2	5.7	7.6
HORRAT R = RSD _R / RSD(R) Horwitz	1.4	1.4	1.8
S _r /S _R	0.64	0.68	0.58

7. BIBLIOGRAPHY

- 7.1 Versini G., Dalla Serra A. and Margheri G. (1984). *Polialcoli e zuccheri minori nei mosti concentrati rettificati. Possibili parametri di genuinità?* Vignevini, 11(3), 41-47
- 7.2 Monetti A., Versini G., Dalpiaz G. and Raniero F. (1996). *Sugar adulterations control in concentrated rectified grape musts by finite mixture distribution analysis of the myo-inositol and scyllo-insitol content and the D/H methyl ratio of fermentative ethanol.* Journal of Agricultural and Food Chemistry, 44-8: 2194-2210.

8. FIGURES

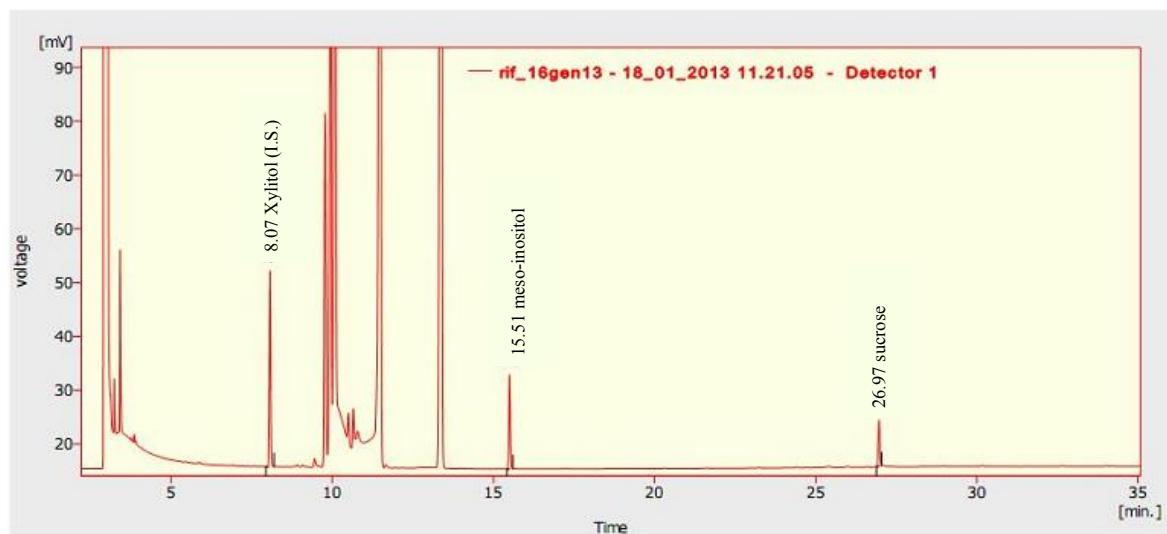

Fig. 9 Chromatogram of the reference solution for the calculation of response factors

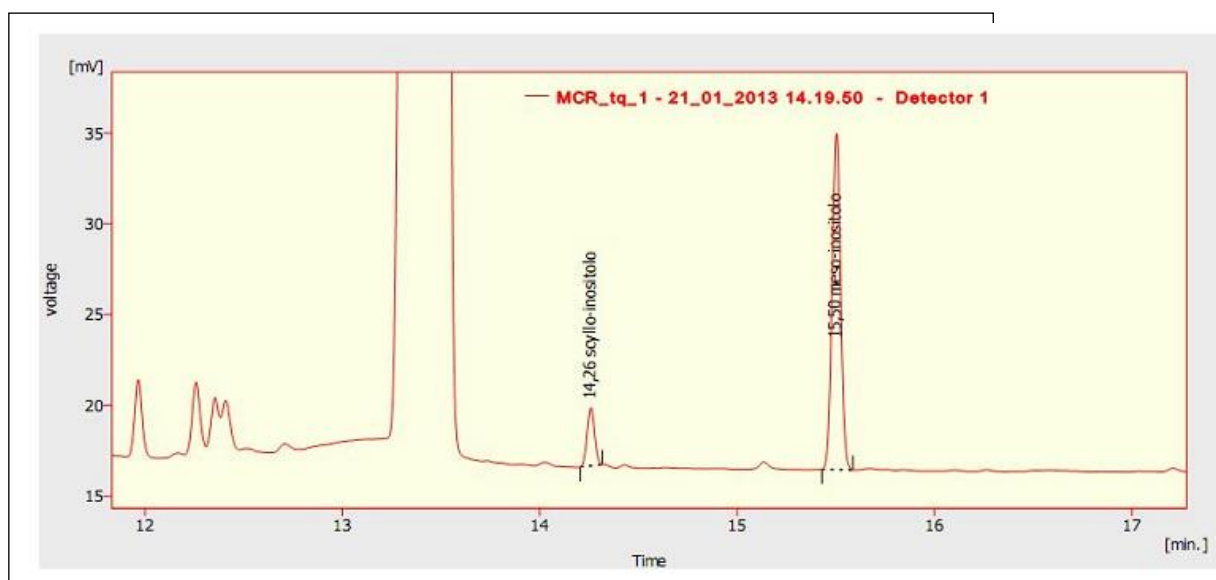
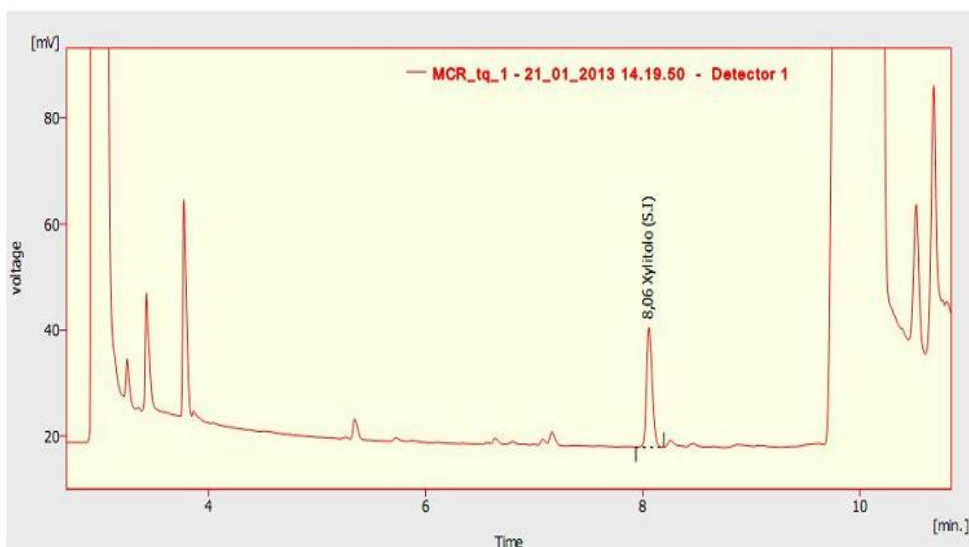

Fig. 10 Chromatogram of an RCM sample – Internal Standard ZONE

Fig. 11 Chromatogram of an RCM sample - “Inositol” ZONE

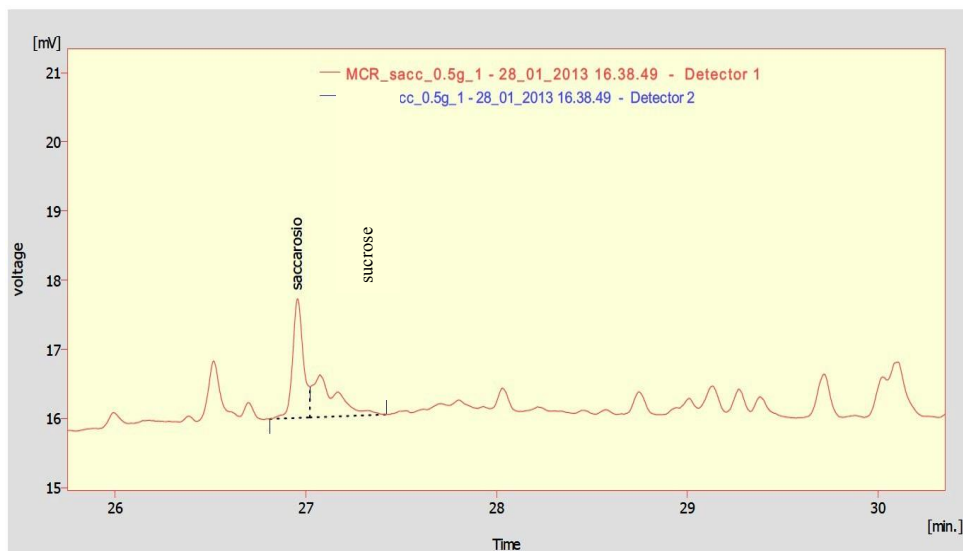

Fig. 12 Chromatogram of an RCM sample –with 0.5 g/kg sucrose added

Method OIV-MA-F1-13

Method type IV

Specific methods for the analysis of grape sugar
(Resolution Oeno 419D/2015)

Folin-Ciocalteu Index

1. DEFINITION

The Folin-Ciocalteu Index is (IFC) the result obtained from the application of the method described below.

This method applies to rectified concentrated must (RCM).

2. PRINCIPLE OF THE METHOD

All phenolic compounds contained in RCM are oxidized by the Folin-Ciocalteu reagent. In RCM other reducing substances can interfere such as, for example, sugars and sulfur dioxide. This interference can be evaluated by measuring a "blank" devoid of phenolic substances, prepared by treating the corresponding sample with activated charcoal.

The Folin-Ciocalteu reagent is formed from a mixture of phosphotungstic acid ($H_3PW_{12}O_{40}$) and phosphomolybdic acid ($H_3PMO_{12}O_{40}$) which, after oxidation of the reducing substances present in the RCM, is reduced to a mixture of the blue oxides of tungsten (W_8O_{23}) and molybdenum (Mo_8O_{23}). The blue coloration produced has a maximum absorption in the region of 750 nm.

3. REAGENTS

These must be of analytical reagent quality.

The water used must be distilled or water of equivalent purity.

3.1 Chemicals

3.1.1 Sodium tungstate dihydrate, $\text{Na}_2\text{WO}_4 \cdot 2\text{H}_2\text{O}$ (CAS Number: 10213-10-2);

3.1.2 Sodium molybdate dihydrate, $\text{Na}_2\text{MoO}_4 \cdot 2\text{H}_2\text{O}$ (CAS Number: 10102-40-6);

3.1.3 Phosphoric acid solution 85 wt. % in H_2O , H_3PO_4 , $\rho_{20} = 1.71$ g/ml (CAS Number 7664-38-2);

3.1.4 Hydrochloric acid, HCl , $\rho_{20} = 1.2$ g/ml (CAS Number 7647-01-0);

3.1.5 Lithium sulfate monohydrate, $\text{Li}_2\text{SO}_4 \cdot \text{H}_2\text{O}$ (CAS Number: 10102-25-7);

3.1.6 Bromine, Br_2 (CAS Number: 7726-95-6);

3.1.7 Sodium carbonate anhydrous, Na_2CO_3 (CAS Number: 497-19-8);

3.1.8 Activated charcoal decolorizing (CAS Number 7440-44-0).

3.2. Folin-Ciocalteu reagent

This reagent is available commercially in a form ready for use.

It may be prepared as follows: dissolve 100 g of sodium tungstate ($\text{Na}_2\text{WO}_4 \cdot 2\text{H}_2\text{O}$) and 25 g of sodium molybdate ($\text{Na}_2\text{MoO}_4 \cdot 2\text{H}_2\text{O}$) in 700 ml of distilled water. Add 50 ml of 85 % phosphoric acid ($\rho_{20} = 1.71$ g/ml) and 100 ml of concentrated hydrochloric acid ($\rho_{20} = 1.19$ g/ml). Bring to the boil and boil for 10 hours under reflux conditions. Then add 150 g of lithium sulphate ($\text{Li}_2\text{SO}_4 \cdot \text{H}_2\text{O}$) and a few drops of bromine and boil once more for 15 minutes. Allow to cool and make up to one liter with distilled water.

3.3. Anhydrous sodium carbonate, Na_2CO_3 , made up into a 20 % w/v solution.

4. APPARATUS

Normal laboratory apparatus, particularly:

- 4.1. 100 ml volumetric flasks.
- 4.2. Spectrophotometer capable of operating at 750 nm.
- 4.3. Technical balance (± 0.01 g)
- 4.4. 50 ml graduated cylinder;
- 4.5. 50 ml beaker;
- 4.6. Magnetic stirrer;
- 4.7. Rapid-filtration filter papers;
- 4.8. 5 ml calibrated pipette;
- 4.9. Optical-glass cuvette;
- 4.10 Ultrasonic bath

5. PROCEDURE

Good repeatability of results is achieved by using scrupulously clean apparatus (volumetric flasks and spectrophotometer cells).

5.1. Preparation of sample

Let P = percentage (m/m) of total sugars in the rectified concentrated must.

Dilute the RCM with distilled water until a total sugar concentration of the solution equal to 25 ± 0.5 % (m/m) (25° Brix): weigh a mass in g equal to $2500/P$ into a volumetric flask (4.1) and make up to 100 g with water.

5.2. Preparation of a blank sample

Take 10 ml from solution 5.1 using the graduated cylinder (4.4), put into a 50 ml beaker (4.5) and add 0,5g of activated carbon (3.1.8).

Leave in contact for 15 minutes with the aid of a magnetic stirrer (4.6), and then filter the solution through a rapid-filtration paper (4.7).

5.3. Color reaction

5.3.1 Color development in the sample

Introduce the following reagents or solutions into a 100 ml volumetric flask (4.1) strictly in the order given below:

- 5 ml of the sample (5.1) using a pipette (4.8),
- 50 ml of distilled water by means of a graduated cylinder (4.4),
- ,
- 5 ml of Folin-Ciocalteu reagent (3.2) using a pipette (4.8),
- 20 ml of sodium carbonate solution (3.2) by means of a graduated cylinder (4.4).

Make up to 100 ml with distilled water. Stir to homogenize. Wait 30 minutes for the reaction to stabilize.

During this period the flasks should be put in an ultrasonic bath (4.10) for 15 minutes to remove any bubbles that may interfere in the spectrophotometric measurement.

5.3.2 Color development in blank

Proceed as described in (5.3.1) by replacing the sample (5.1) with a blank (5.2).

5.4. Measurement

Determine the absorbance at 750 nm through an optical-glass cuvette with a path length of 1 cm, with respect to a blank (5.2).

If the absorbance is not around 0.3 an appropriate dilution should be made until the measured absorbance falls to around 0.3.

6. EXPRESSION OF RESULTS

6.1. Method of calculation

The result is expressed in the form of an index obtained by multiplying the absorbance by 16, with one decimal point.

The FCI value calculated should be corrected for the blank according to the following formula:

$$\text{FCI measured at } 25^{\circ}\text{Brix} = 16 d (A - A_{\text{blank}})$$

where:

A = absorbance at 750 nm measured on the sample at 25 ± 0.5 % (m/m)

(5.1)

A_{blank} = absorbance at 750 nm measured on the blank (5.2)

d = an appropriate factor if a dilution has been done (5.4)

7. METHOD PERFORMANCE

The method was checked in the ICQRF laboratory in Conegliano (Italy) analyzing two RCM samples. Each sample was further enriched in SO₂ at a concentration 5 mg/Kg TS (mg per Kg of total sugar). The samples were analyzed three times:

Samples	FC index at 25°Brix			Media	SD	r=2.8xSD
RCM 1	5.4	4.9	5.3	5.2	0.3	0.8
RCM 2	2.2	2.4	1.9	2.2	0.2	0.7

Further data was provided from the ASAE laboratory (Portugal):

COMPENDIUM OF INTERNATIONAL METHODS OF ANALYSIS-OIV
Specific methods for the analysis of grape sugar

Number of samples	Concentration range	Sr	r	SR	R
21	From 1 to 5.3	0.25	0.7		
21	From 1 to 5.0			0.91	2.5

(All Rights Reserved) According to the law, the OIV declines all responsibility for involuntary errors or omissions that might occur, despite care taken in the editing. Reproduction of texts published in this work is forbidden. These texts are the property of OIV, which has the exclusive right to reproduce and translate these texts throughout the world. The law forbids copies and reproductions for group usage. Any representation or reproduction, whether complete or partial, by any means, without the accord of the OIV, is an unlawful act and constitutes an infringement of copyright.

© OIV – 2022

Printed in Paris (France)

35, Rue de Monceau

75008 Paris, France

Legal Deposit : August 2021

ISBN : 978-2-85038-052-5 volumes I and II

ISBN : 978-2-85038-054-9 vol II

INTERNATIONAL ORGANISATION OF VINE AND WINE

35, Rue de Monceau

75008 PARIS

Tél. (33) 01.44.94.80.80 - Tlc. (33) 01.42.66.90.63

E-mail: oiv@oiv.int - www.oiv.int